

Melegen hengerelt SZERKEZETI ACÉLOK

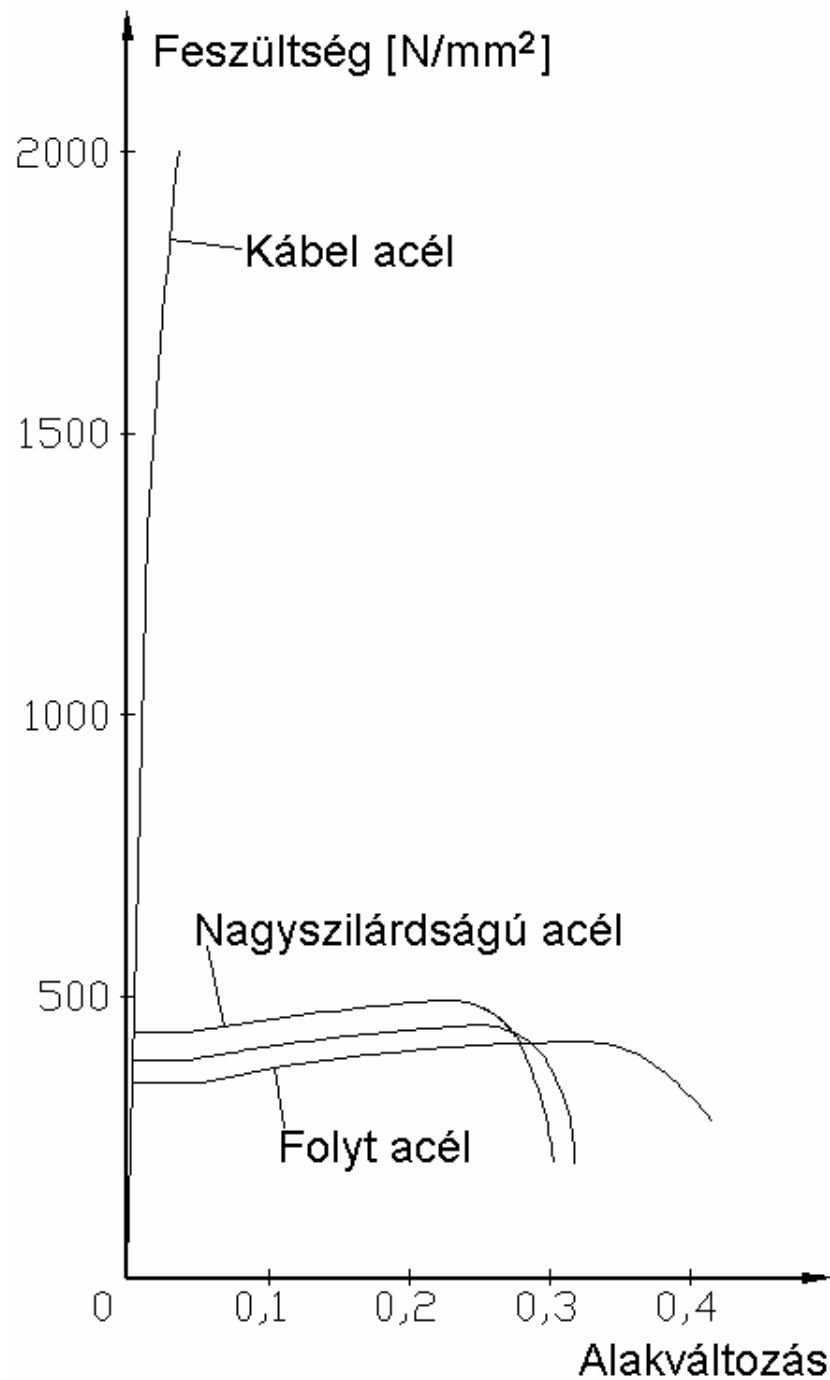

Szerkezeti acél

Kísérlet:

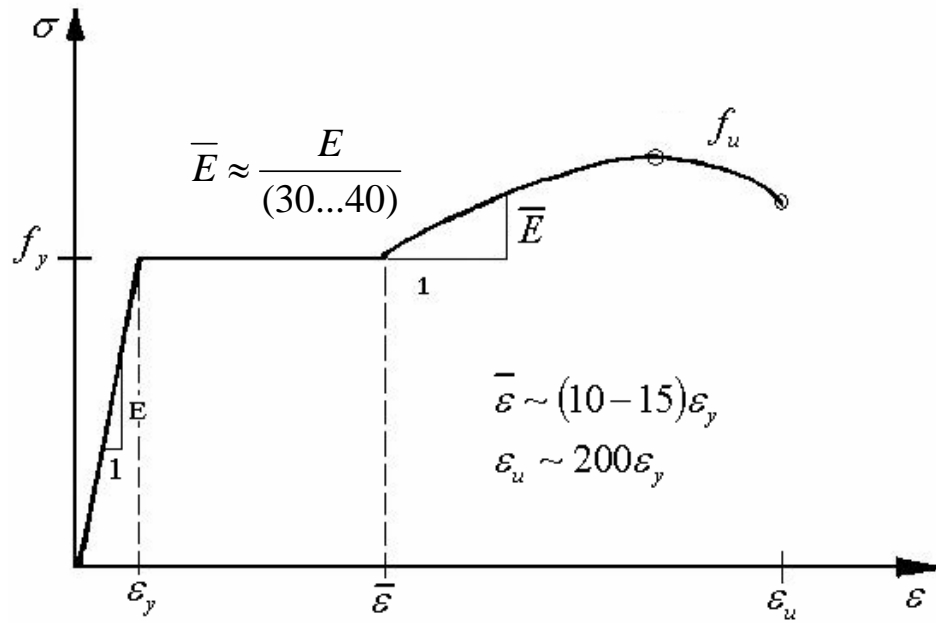

Rugalmas

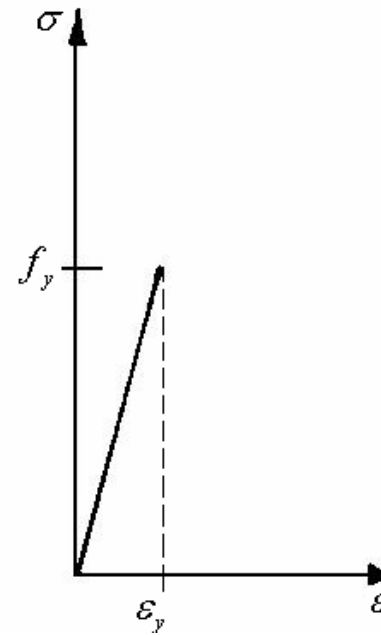

Képlékeny

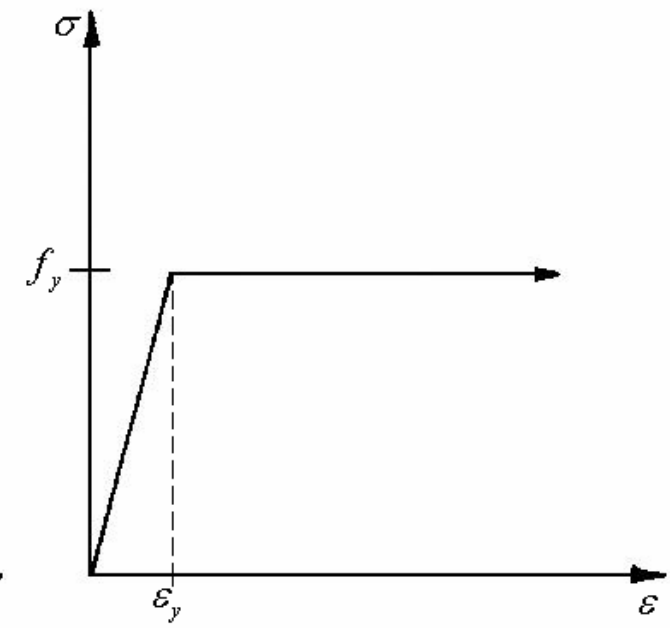

SZERKEZETI KERESZTMETSZETEK

Melegen hengerelt szelvények (I.)

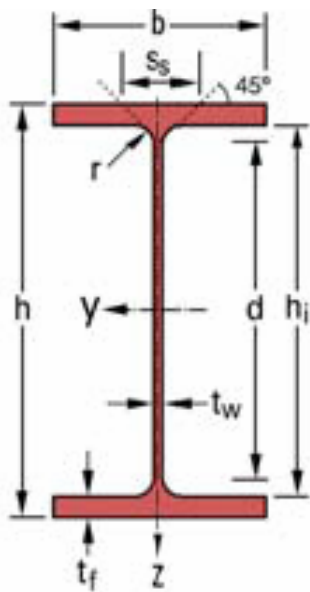

**IPE, párhuzamos övű
I szelvények**

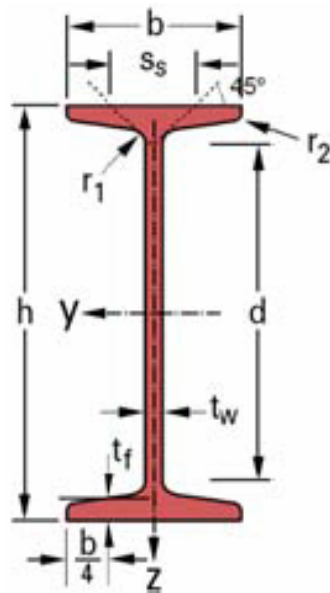

**IPN, lejtős övű
I szelvények**

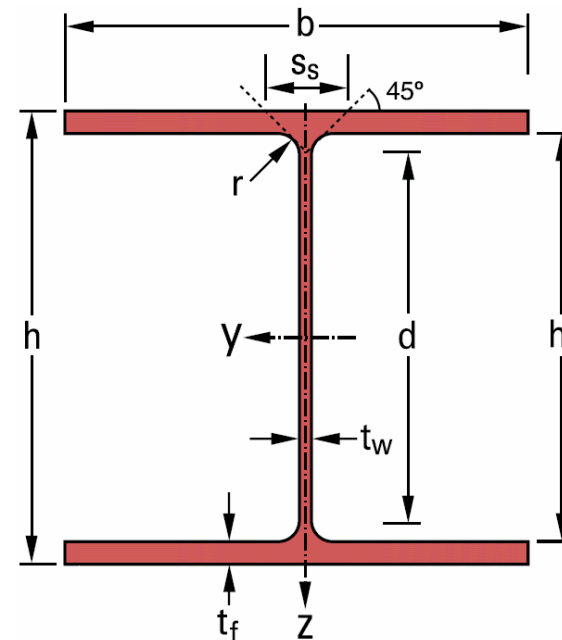

**HE, széles övű
I szelvények**

Melegen hengerelt szelvények (II.)

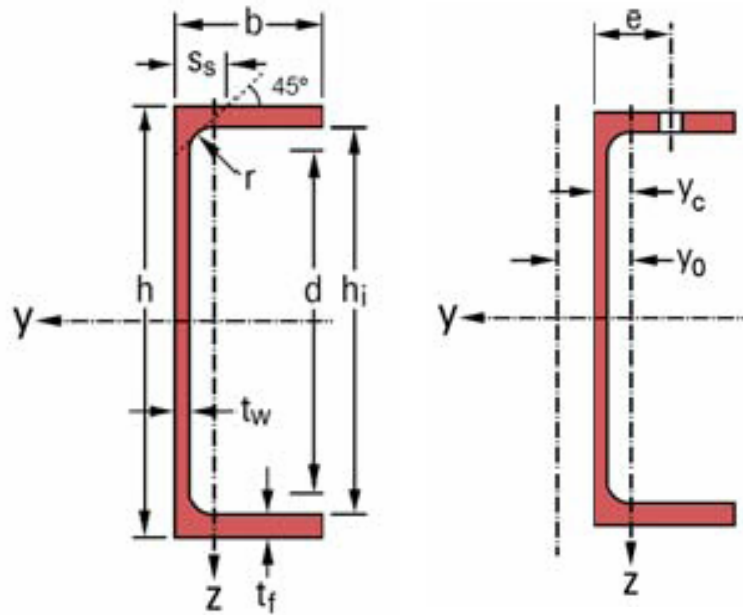

**UAP, párhuzamos övű
U szelvények**

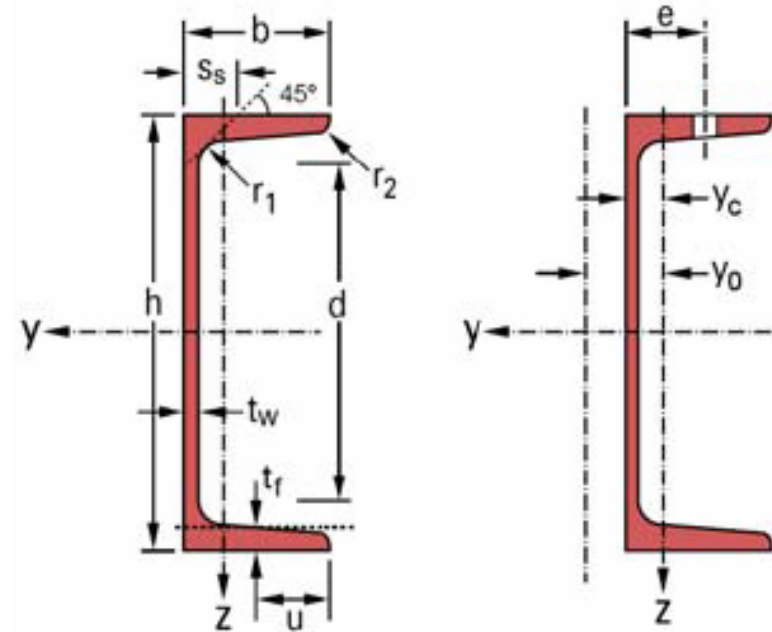

**UPN, lejtős övű
U szelvények**

L, egyenlőszárú párhuzamos övű szögacélok

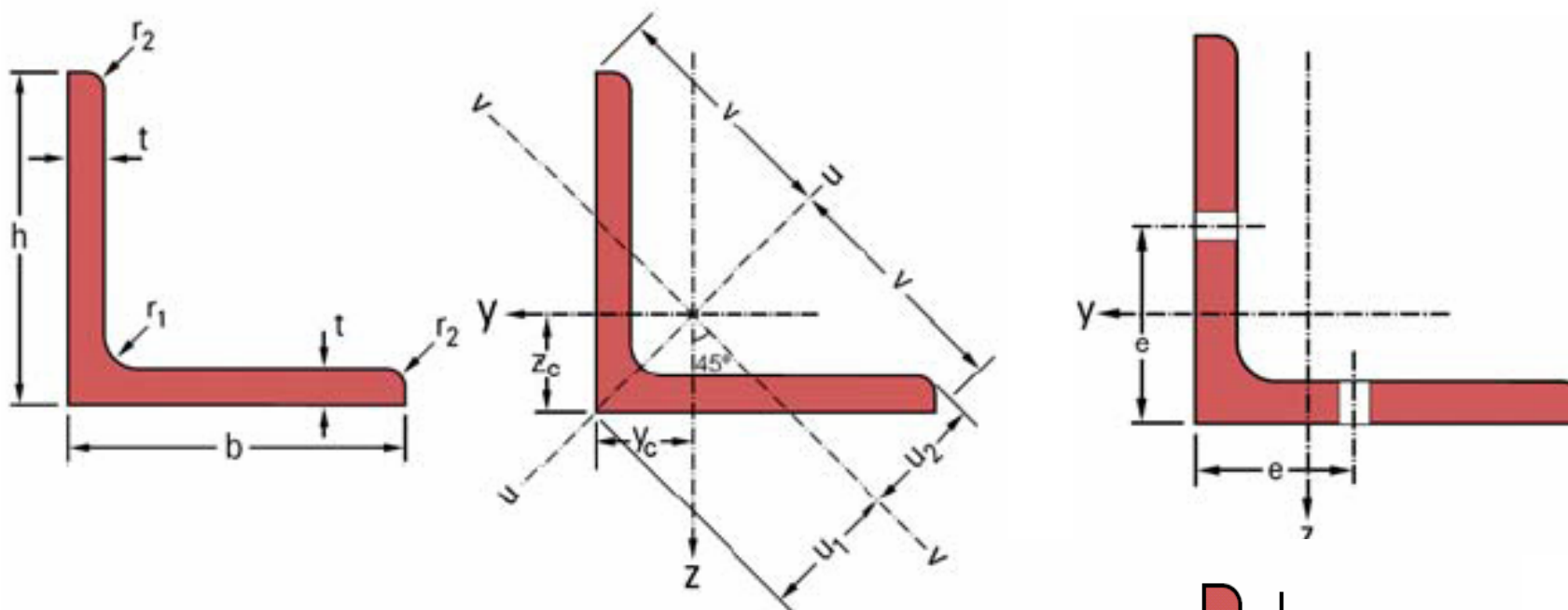

L, egyenlőtlen szárú párhuzamos övű szögacélok

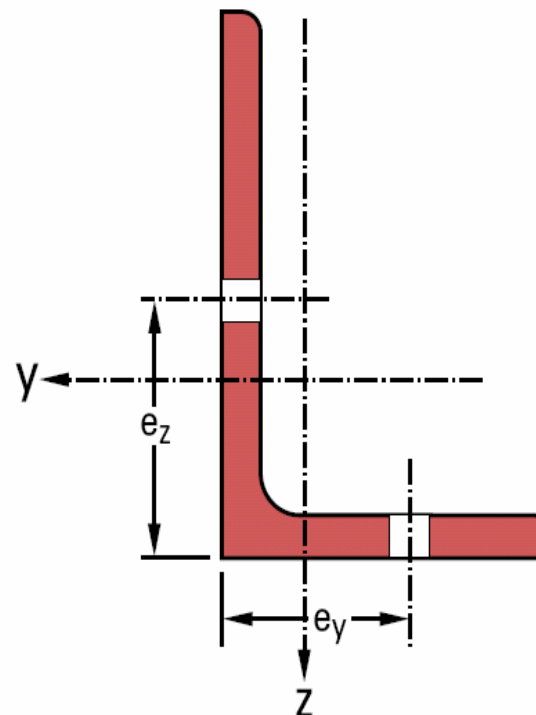

Melegen hengerelt szelvények (III.) Darusínek

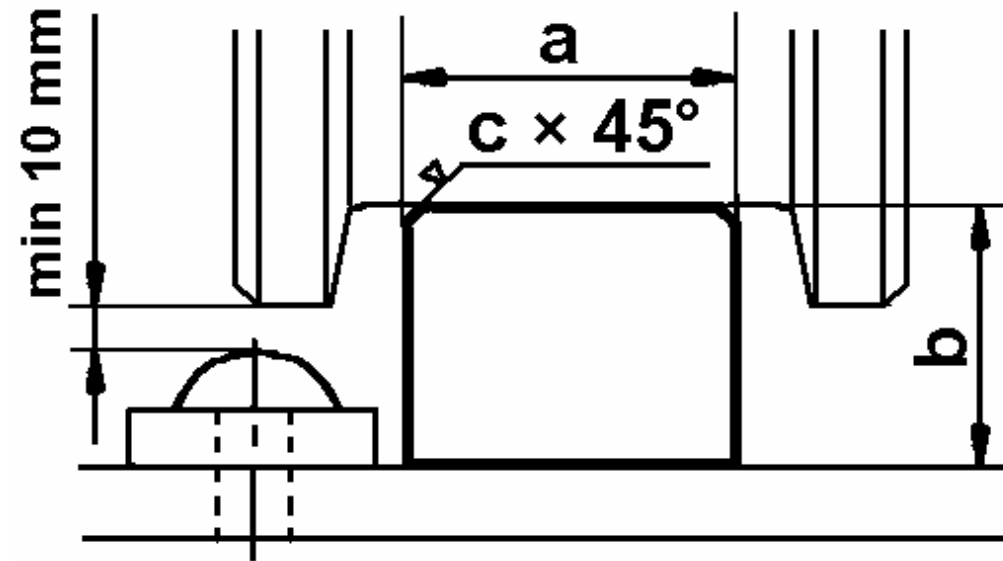
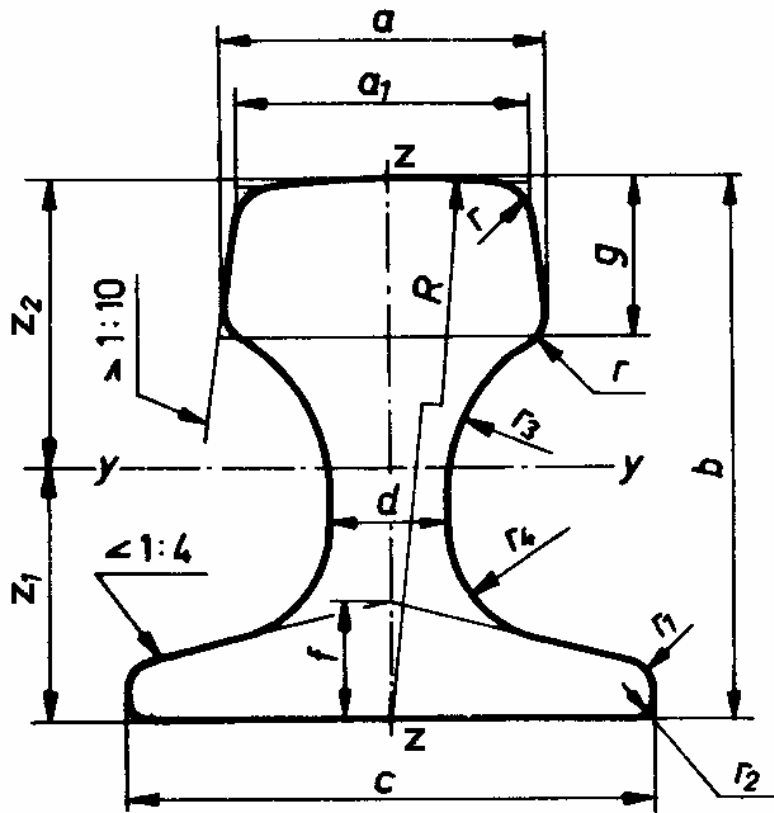

Melegen hengerelt szelvények (IV.)

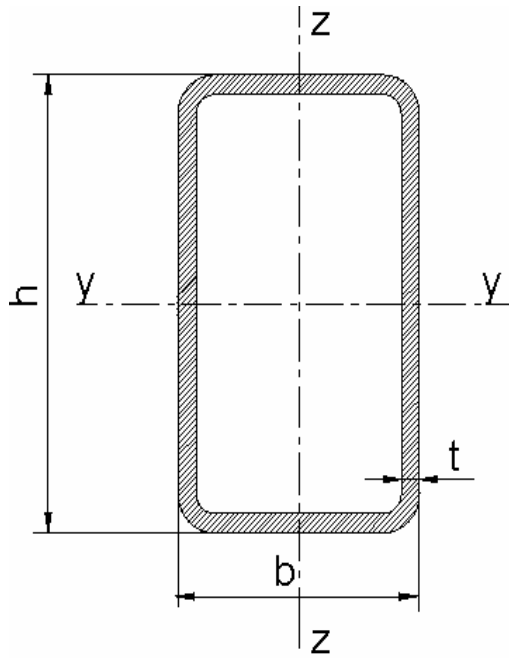

**RHS jelű téglalap szelvényű
zárt idomacélok**

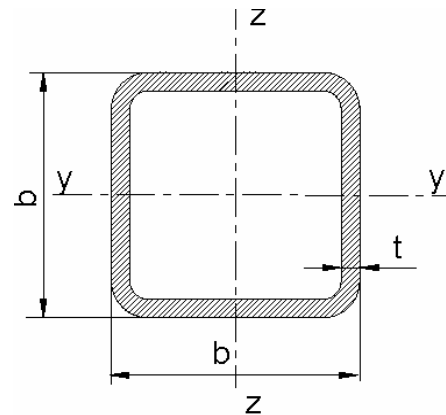

**RHS jelű négyzet szelvényű
zárt idomacélok**

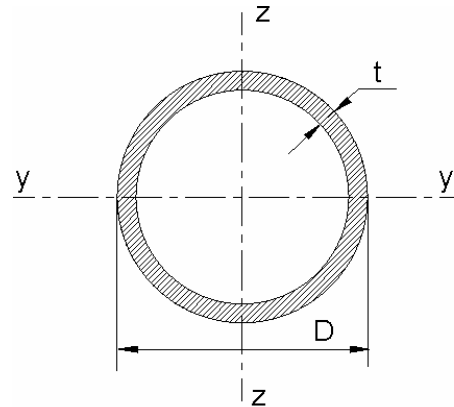

**CHS jelű körszelvényű
zárt idomacélok**

Tipikus melegen hengerelt szelvények



Gerenda

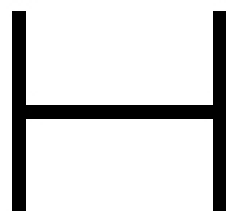

Oszlop



Szádpalló

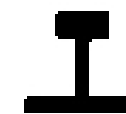

Darusín



U-szelvény



Szögacél

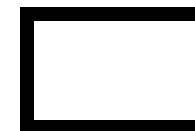
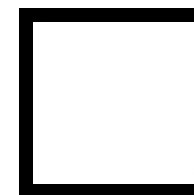
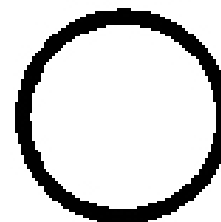

Zártszelvények



T-szelvény



Hengerelt merevítő

Hidegen alakított szelvények (I.)

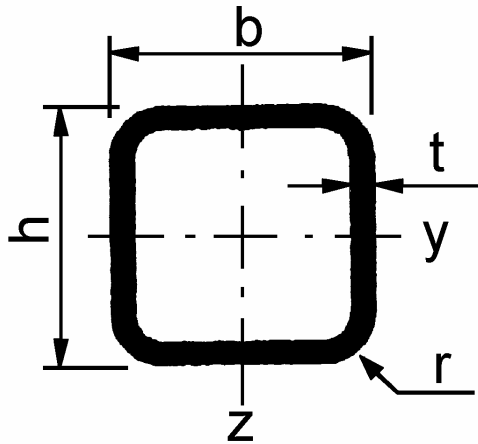

SHS jelű négyzet keresztmetszetű zárt szelvények

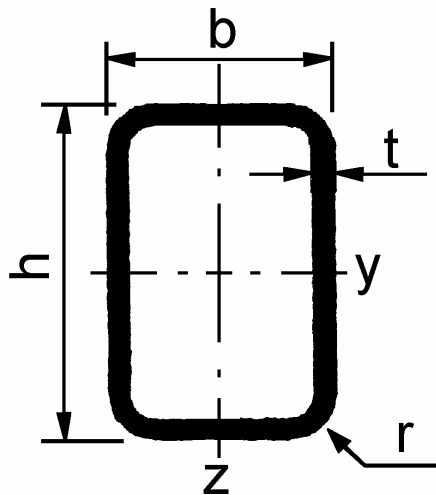

SHS jelű téglalap keresztmetszetű zárt szelvények

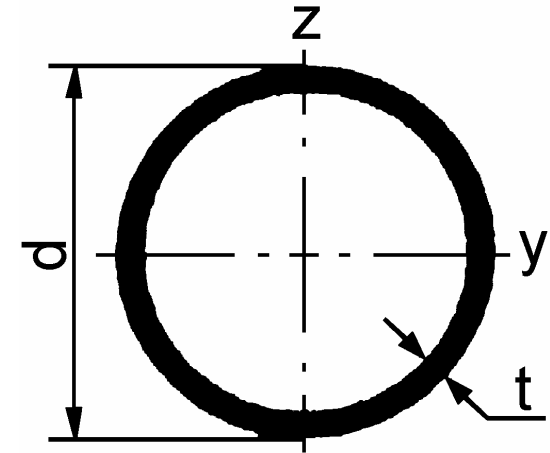

CHS, hosszvarratos kör keresztmetszetű zárt szelvények

CHS, spirálvarratos kör keresztmetszetű zárt szelvények

Hidegen alakított szelvények (II.):

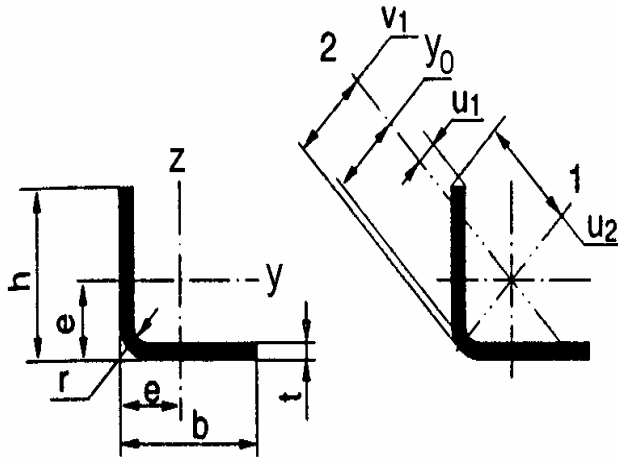

Hidegen hajlított egyenlő szárú L-szelvény

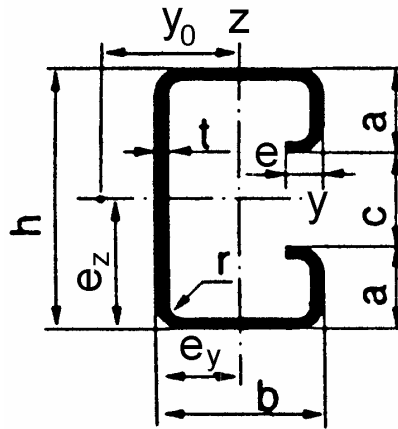

Hidegen hajlított merevített C-szelvény

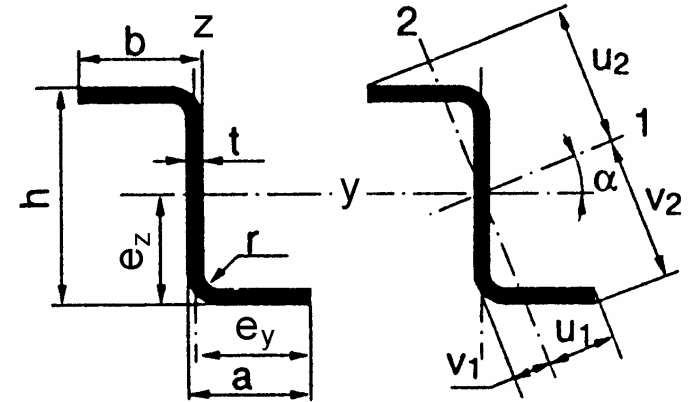

Hidegen hajlított Z-szelvény

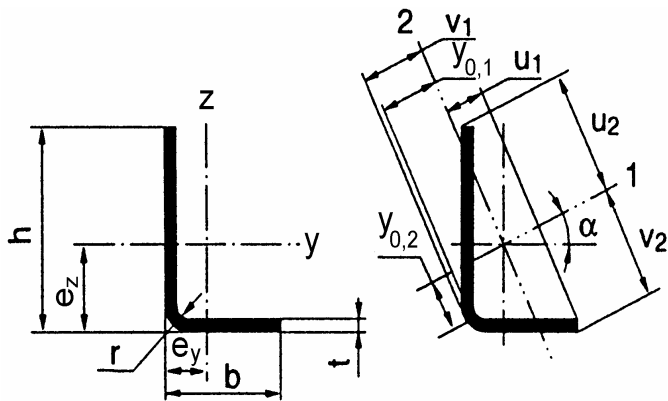

Hidegen hajlított egyenlőtlen szárú L-szelvény

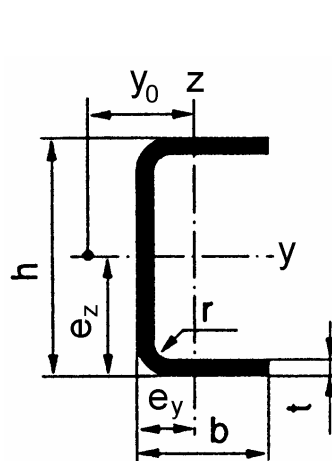

Hidegen hajlított U-szelvény

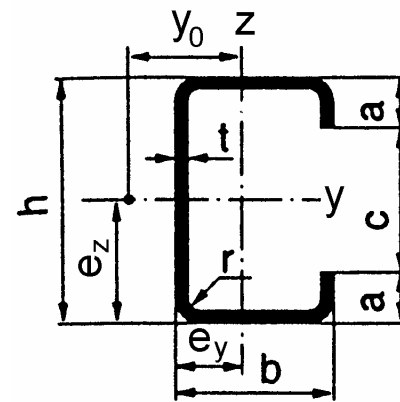

Hidegen hajlított C-szelvény

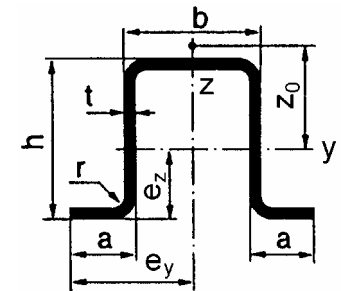

Kalapszelvény

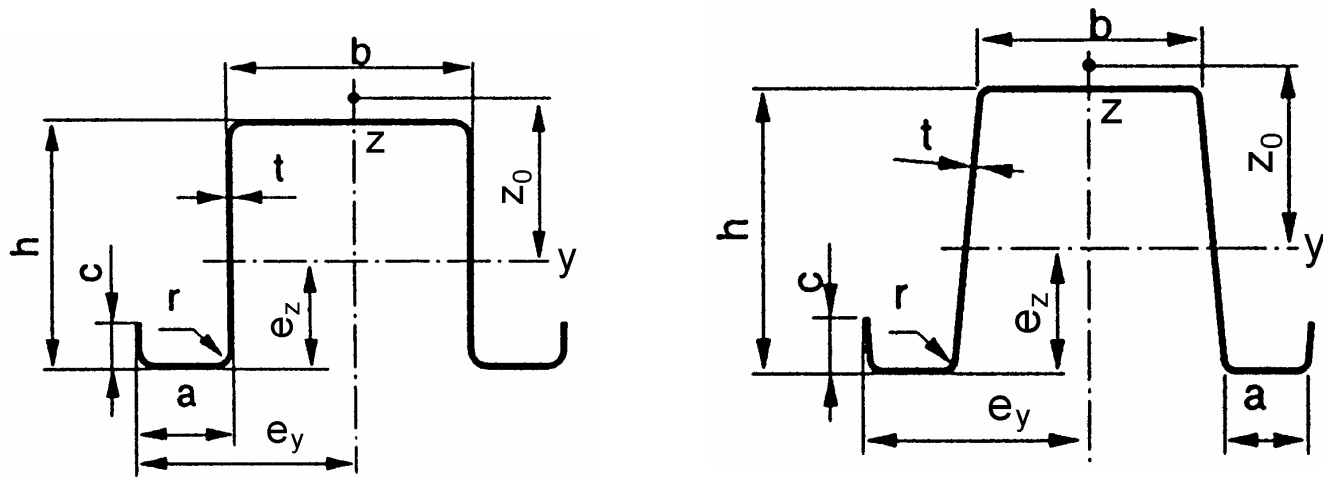

Merevített kalapszelvény

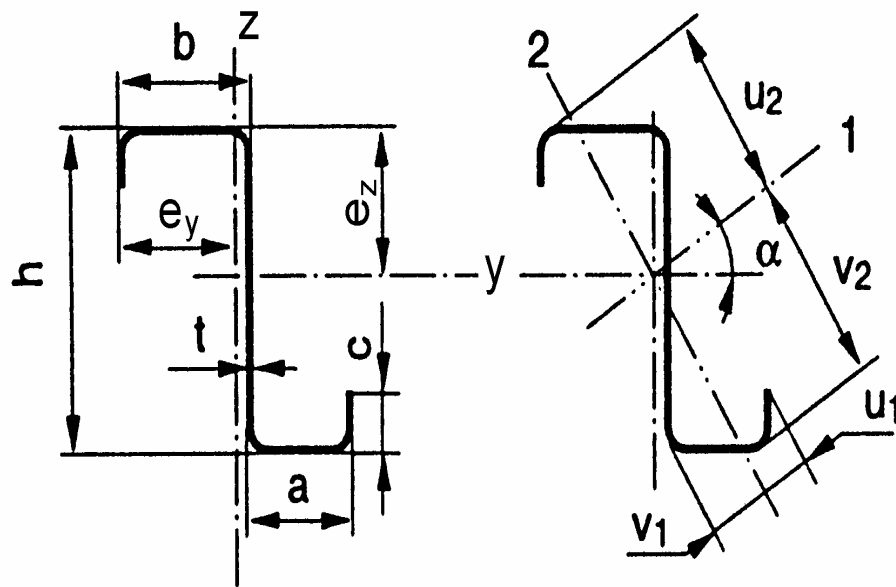

Merevített hidegen hajlított Z szelvény

Tipikus hidegen alakított szelvények

U-szelvények

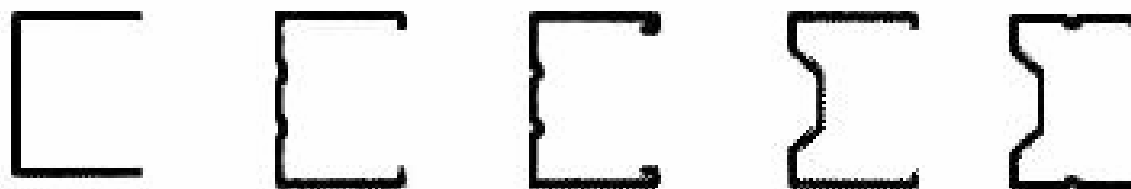

Z szelvények



Speciális szelvények



Összetett szelvények



Hullámlemezek

METAB típusú trapéz hullámlemezek

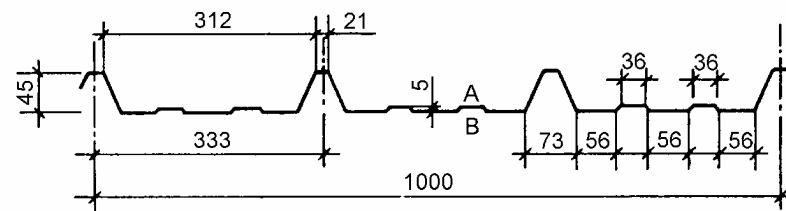
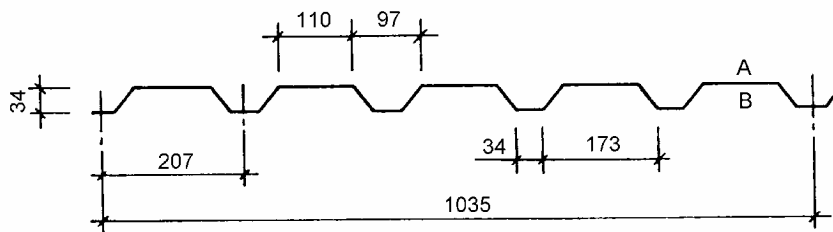
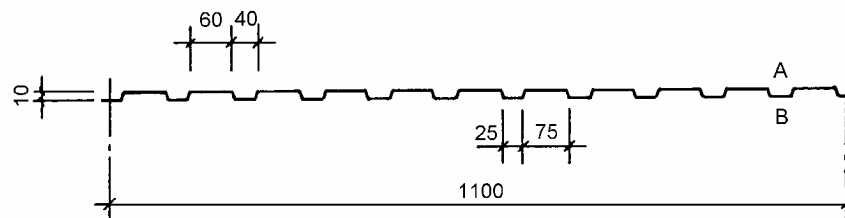

LINDAB típusú hullámlemezek

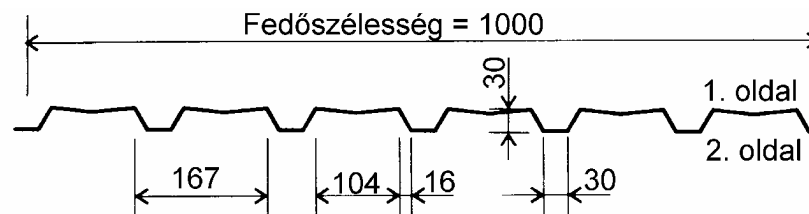
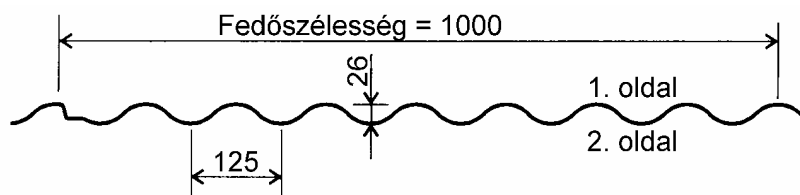
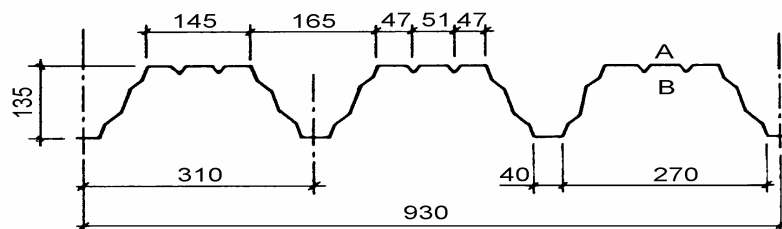

Rannila Steel típusú hullámlemezek

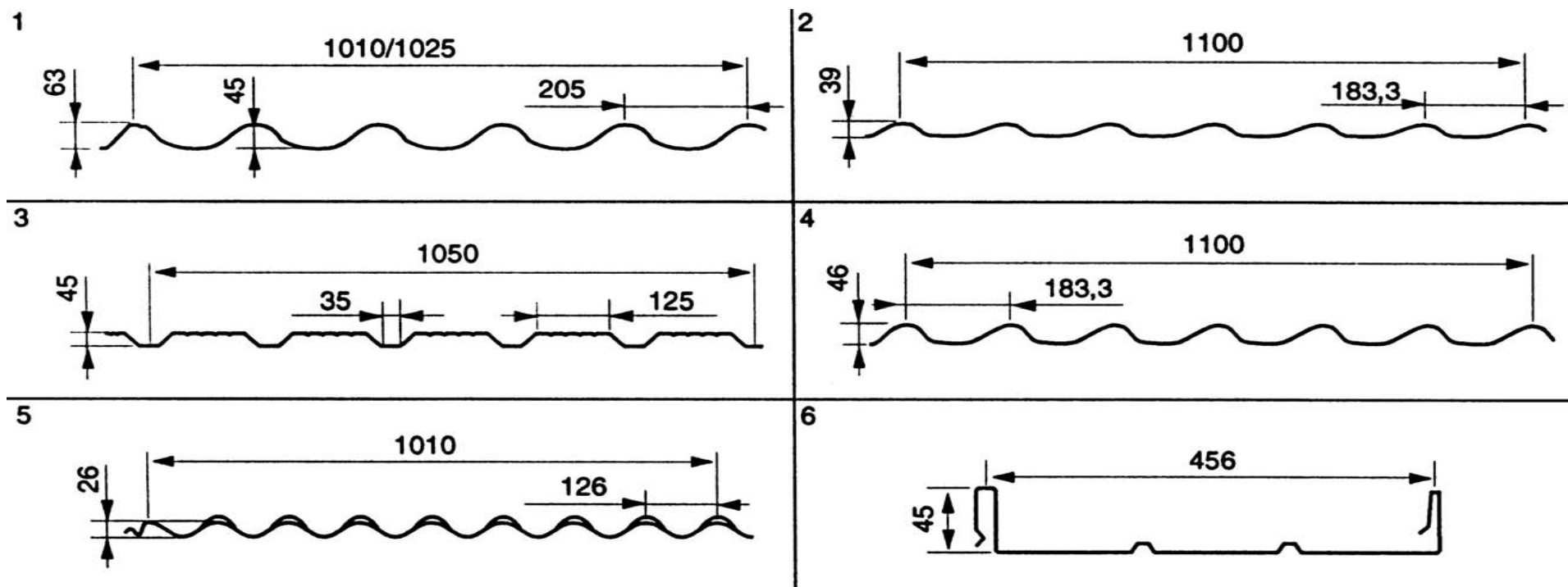

Szegecselt keresztmetszetek

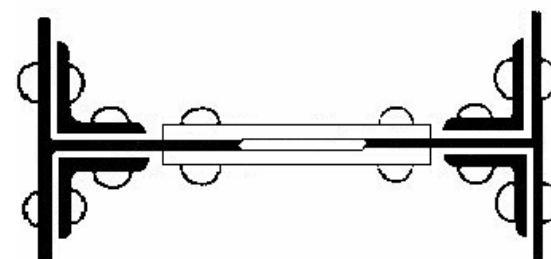
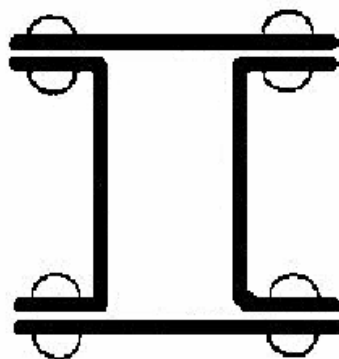
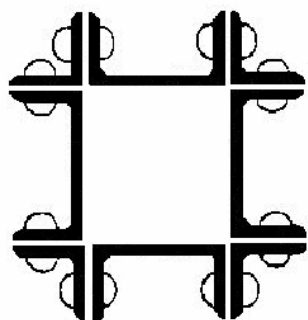
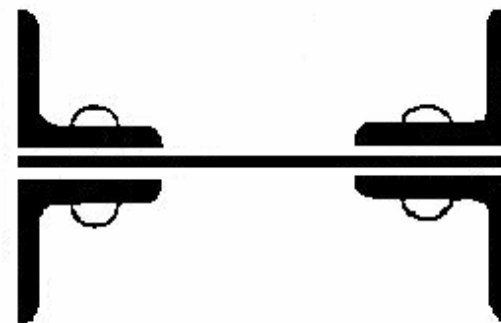
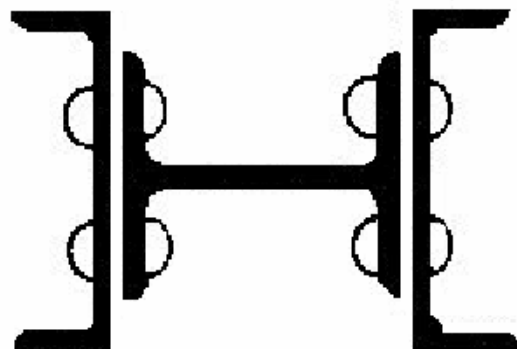

Hegesztett keresztmetszetek

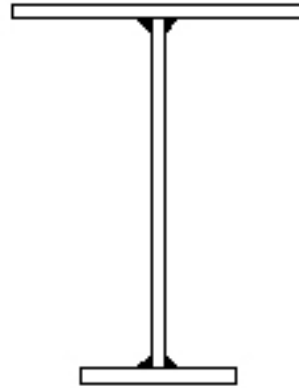
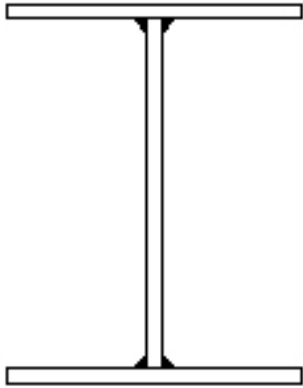

IPE hengerelt
szelvény

