

Planungshandbuch

Design Manual



Fenstersysteme
Window systems



» Technik für Ideen

Technology for ideas

Planen und Bauen fordern Kreativität und Gestaltungsfreiheit. Ideen werden gebaute Wirklichkeit. Diesen Prozess begleiten wir als Aluminium-Systemhaus im Dialog mit Ihnen mit unserem Know-how, Hightech-Produkten und perfektem Service. Von der ersten Skizze bis zur Umsetzung. WICONA.

Planning and designing demand a high level of creativity and artistic freedom in order to turn ideas into actual buildings. In a close dialogue we support this dynamic process with our know-how, high-tech products and perfect service. From the first sketch to the last assembly step. WICONA.



Alles für anspruchsvolle Architektur <i>Solutions for ambitious architecture</i>	4 - 5
Das Fenster der Zukunft <i>The window for the future</i>	6 - 25
Systemübersicht – Technische Datenblätter <i>System overview – Technical data sheets</i>	26 - 58
Wärmedämmung <i>Thermal insulation</i>	2/1 - 2/46
Schallschutz <i>Sound insulation</i>	3/1 - 3/4
Sicherheit (Einbruch- / Durchschusshemmung) <i>Safety (Burglar / bullet resistance)</i>	4/1 - 4/40
Brandschutz <i>Fire protection</i>	5/1 - 5/4
Beschläge <i>Fittings</i>	6/1 - 6/108
Sonnenschutz <i>Sun shading</i>	7/1 - 7/6
Konstruktionsschnitte <i>Construction sections</i>	8/1 - 8/56
Bauanschlüsse <i>Junction to structure</i>	9/1 - 9/88
Profile <i>Profiles</i>	10/1 - 10/26



» Alles für anspruchsvolle Architektur

*Solutions for ambitious
architecture*

FENSTER | WINDOWS

WICLINE®

Lochfenster und Fensterbänder
Verbundfenster
Hybridfenster

*Punched / ribbon windows
Coupled windows
Hybrid windows*



WICLINE 65 evo
WICLINE 75 evo



WICLINE 125



WICLINE 215

TÜREN | DOORS

WICSTYLE®

Anschlagtüren
Sicherheitstüren
Automatik-Schiebetüren

*Hinged doors
Safety doors
Automatic sliding doors*



WICSTYLE 65 evo
WICSTYLE 75 evo
WICSTYLE 88



WICSTYLE 77 FP



WICSTYLE 65ED

SCHIEBEELEMENTE | SLIDING ELEMENTS

WICSLIDE®

Schiebetüren
Hebe-Schiebetüren
Falt-Schiebetüren

*Sliding systems
Lifting sliding systems
Folding sliding systems*



WICSLIDE 160
WICSLIDE 24E/24EN



WICSLIDE 65FS

FASSADEN | FAÇADES

WICTEC

Pfosten-Riegel-Fassaden
 Passivhausfassaden
 Elementfassaden
 Doppelfassaden
 Ganzglasfassaden
 Einsatzfenster

Stick curtain walls
Passive house curtain walls
Unitized curtain walls
Double skin façades
Structural glazing curtain walls
Insertion windows



WICTEC 50
 WICTEC 60



WICTEC 50EL
 WICTEC EL60



WICTEC 50SG



WICLINE 90SG

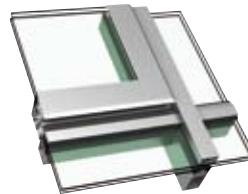

WICTEC 50

SONNENSCHUTZ | SUNSHADE

WICSOLAIRE



WICSOLAIRE

» Das Fenster der Zukunft

The window for the future

kombiniert Energieeffizienz und Gestaltungsfreiheit, Funktion und ökologische Verantwortung

WICLINE evo erzielt absolute Spitzendämmwerte für Fenster und Festverglasungen bis zu $U_w = 0,84$ bzw. $0,72 \text{ W/(m}^2\text{K)}$. Als Ergebnis sind auch mit Aluminiumfenstern Wärmedämmwerte auf Passivhausniveau möglich. In der Schweiz wurde das System als bisher einziges Metallfenster nach Minergie-P zertifiziert, auf Basis der Serie WICLINE 75 evo, mit nur geringfügigen Anpassungen. Kostengünstig, langlebig, wartungsarm und mit schlanken Profilansichten auch bei großflächigen, z. B. geschosshohen, Verglasungen.

combines energy efficiency with freedom in design, function and environmental responsibility

WICLINE evo sets new standards for windows and fixed glazings with U_w values down to 0.84 resp. $0.72 \text{ W/(m}^2\text{K)}$. This means passive house level. In Switzerland the system has been the first metal window be awarded the Minergie-P certification. This has been achieved with the standard WICLINE 75 evo series, with minor modifications. Cost efficient, long lasting, virtually maintenance free and with slim profile sections for maximum transparency even in big size windows.

So erreichen Sie Ihre gewünschten U_w -Werte: (Ein kleiner Auszug aus möglichen Profilkombinationen)

Reach your aspired U_w value easily: (extract from possible profile combinations)

Fenster Normgröße 1,24 x 1,48 m <i>Window standard size 1.24 x 1.48 m</i>	Zweifachglas <i>Double glazing</i>	Dreifachglas <i>Triple glazing</i>
WICLINE 65 evo, Flügel, Ansicht 95 mm <i>WICLINE 65 evo, sash, width 95 mm</i>	$U_w = 1,4 \text{ W/(m}^2\text{K)}$	$U_w = 0,93 \text{ W/(m}^2\text{K)}$
WICLINE 75 evo, Flügel, Ansicht 95 mm <i>WICLINE 75 evo, sash, width 95 mm</i>	$U_w = 1,3 \text{ W/(m}^2\text{K)}$	$U_w = 0,88 \text{ W/(m}^2\text{K)}$
WICLINE 75 evo, Flügel/Festverglasung, Ansicht 120 mm <i>WICLINE 75 evo, sash/fixed glazing, width 120 mm</i>	$U_w = 1,3 \text{ W/(m}^2\text{K)}$	$U_w = 0,78 \text{ W/(m}^2\text{K)}$
WICLINE 75 evo, verdeckter Flügel, Ansicht 80 mm <i>WICLINE 75 evo, concealed sash, width 80 mm</i>	$U_w = 1,4 \text{ W/(m}^2\text{K)}$	$U_w = 0,88 \text{ W/(m}^2\text{K)}$
WICLINE 75 evo, Festverglasung, Ansicht 48 mm <i>WICLINE 75 evo, fixed glazing, width 48 mm</i>	$U_w = 1,3 \text{ W/(m}^2\text{K)}$	$U_w = 0,72 \text{ W/(m}^2\text{K)}$





WICLINE evo bietet eine Vielzahl an Innovationen, mit denen Sie Ihre Gestaltungsideen für die Architektur gebaute Wirklichkeit werden lassen können.

Architektonische Vielfalt: 1 System, 2 Bautiefen, unendlich viele Varianten. Verdeckter Flügel, Klassik-Design oder Sonderöffnungsarten auch nach außen, unsichtbar integrierte Funktionen wie Einbruchhemmung bis RC3/WK3 oder Schallschutz bis 47 dB, Einsatz in Fensterbändern, Lochfenstern oder als Einsatzfenster in Pfosten-Riegel-Fassaden.

Leistungsfähigkeit: Größere Flügelformate bis 2.500 mm Höhe, Füllungsdicken bis 69 mm und Flügelgewichte bis 200 kg, Flügelgewichte bis 300 kg objektspezifisch realisierbar. Durch das WICONA Unisys Prinzip sind nachträgliche Änderungen der Flügelgewichte, Füllungsdicken und Öffnungsfunktionen einfach umsetzbar.

Design: Puristisches Design mit verdecktem Beschlag oder Akzentuierung durch aufliegende Bänder. Alle sichtbaren Teile können farbig eloxiert oder beschichtet werden.

Dichtigkeit: Eine spezielle hochwärmedämmende Mitteldichtung stellt die hohe Dichtigkeit der Fenster sicher. Der Einbau erfolgt umlaufend ohne alterungsempfindliche Verklebungen.

Langlebigkeit: Unsere höchsten Ansprüche an Technologie, Qualität, Prozesssicherheit und Langlebigkeit stellen sicher, dass Ihre Nutzer die Vorteile von WICLINE evo dauerhaft genießen können.

Auszug aus dem Testbericht:
 U_f -Werte bis 0,8 W/(m²K):

Extract from the test report:
 U_f values down to 0,8 W/(m²K):

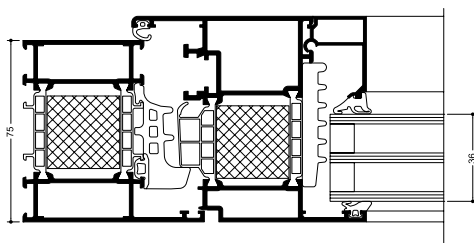

DIN EN ISO 10077-2:2003 Wärmetechnisches Verhalten von Fenster, Türen und Abschlüssen. Berechnung des Wärmedurchgangskoeffizienten. Teil 2 Numerische Verfahren für Rahmen. IFT – Richtlinie WA-01/1 Juli 2002 – U_f -Werte für thermisch getrennte Metallprofile aus Fenstersystemen.

DIN EN ISO 10077-2:2003 Thermal behaviour of windows, doors and building connections. Calculation of the thermal coefficients, part 2 numeric method for frames. IFT rule WA 01/1 July 2002 U_f values for metal profiles with thermal break for window systems.

WICLINE evo features a multitude of innovations which enable you to fulfill your requirements and make your ideas become reality.

Architectural diversity: 1 system, 2 profile depths, endless variations. Concealed sash, classic design or special opening types inwards and outwards, invisibly integrated functions like burglar resistance or sound insulation up to 47 dB, application in ribbon or punched windows or in curtain walls.

Performance: Big sash sizes up to 2500 mm height, infill thickness until 69 mm, sash weight until 200 kg, 300 kg for project requirements. Posterior adaptation of sash weight, infill thickness or opening function is possible due to the WICONA Unisys technology.

Design: Pure reduced look with concealed fittings or accentuation with visible hinges. All visible fitting parts can be anodized or powder coated in various colours.

Tightness: A special high insulation central gasket assures the superior tightness of the window. The installation is made without any aging glue connection.

Durability: Our highest demand in technology, quality, process reliability and endurance make sure that the user can benefit from the WICLINE advantages over an extended life time.

Auszug aus dem Minergie-P®-Zertifikat:
 U_w -Werte bis 0,8 W/(m²K) bei Stulpfenster

Extract from the Minergie-P® certificate:
 U_w values down to 0.8 W/(m²K) for double casement windows



MINERGIE-P®-Fenster

Code Nr. 516.10

Diese Fensterkonstruktion erfüllt den MINERGIE-P®-Standard, der von Kantonen, Bund und Wirtschaft getragen wird. Ein MINERGIE-P®-Fenster ist ein Fenster, welches dem höchsten Stand der Technik entspricht, insbesondere bezüglich Wärmedämmfähigkeit, Kondensatfreiheit und Dichtigkeit sowie ein gutes Preis-Leistungsverhältnis aufweist. Die Konstruktion WICONA WICLINE 75 darf als MINERGIE-P®-Modul-Fenster bezeichnet werden.

This window fulfills the Minergie-P® standard of Swiss cantons. A Minergie-P® window is a window which meets the highest standards of technology, especially in terms of thermal insulation performance, freedom of condensate and tightness, and offers a good price-value ratio. The construction WICONA WICLINE 75 may be called a Minergie-P® module.

» Fenster | Charakter geben

Windows | Conferring character

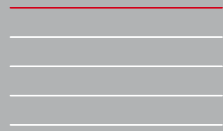



Jedes Gebäude ist einzigartig. Und zu einer besonderen Architektur gehören individuelle Fenster. Sie prägen in höchstem Maße die Ästhetik der gesamten Fassade und damit den Charakter des Hauses. Mit der WICLINE Serie verfügen Sie über beste Voraussetzungen für anspruchsvolle Fenster in attraktivem Design, hoher Funktionalität und maßgenauer technischer Ausstattung. Das WICLINE Programm beinhaltet mehrstufige Konzepte für Sicherheit, Wärme- und Schallschutz sowie mit WICSTAR ein hochwertiges System-Beschlagssortiment. Die umfangreiche Systemvielfalt bietet eine große Auswahl an Öffnungsmöglichkeiten nach innen und nach außen. Ein umfassendes Programm an Profilvarianten erlaubt Ihnen die individuelle Anpassung an jeden Gestaltungswunsch. Für besondere Anforderungen können Sie auf zweischalige Konstruktionen oder Hybrid-Technologie zurückgreifen. Aus einem Systemgedanken heraus alle Anforderungen erfüllen zu können – das nennen wir Technik für Ideen.

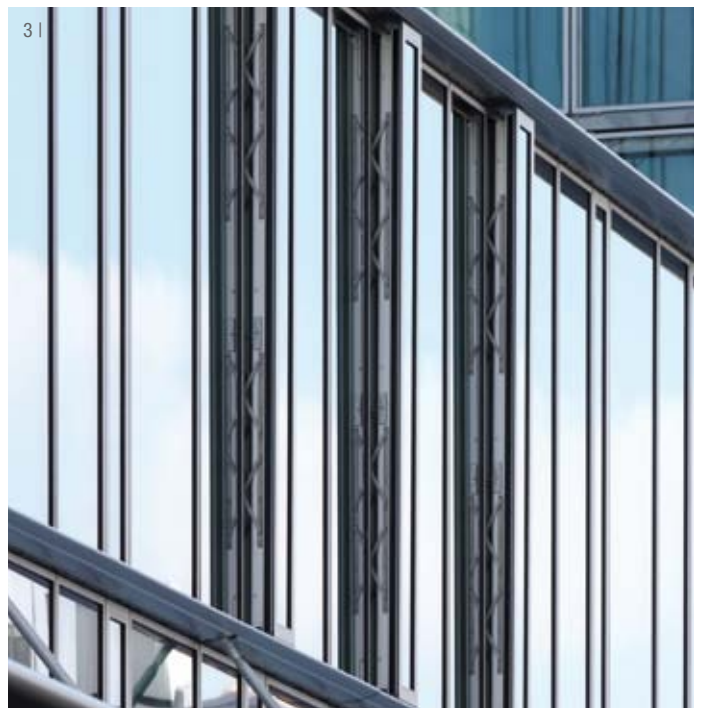

Every building is unique. Individually designed, high performance windows are a key part of any architectural design, determining the form of the entire building skin and setting the features and character of the construction. The WICLINE series provide advanced and highly insulated window systems with an extended level of functionality and precision. The range includes multi-level concepts for security and for both thermal and acoustic insulation, whilst WICSTAR offers a range of high quality system fittings. This extensive choice provides a wide scope of options for natural ventilation, inward and outward opening vents, and different window configurations. A wide range of profile designs enhances the individual adaptation to any requirement. For more sophisticated building designs you can rely on the performance of our double-skin or our hybrid window technology. Supplying solutions to all requirements out of one system philosophy – this is what we call Technology for ideas.

- 1 | Spirig Pharma, Egerkingen (CH)
BFB, Egerkingen
Marbed Metallbau, Gunzgen
- 2 | City Tower, Bolzano (I)
Roberto Nicoli, Bolzano
Intercom, Cittadella
- 3 | Bahnhof / railway station, Aarau (CH)
Theo Hotz, Zürich
Ernst Schweizer, Heidingen
- 4 | Holmenkollen Skisprungschanze / ski jump, Oslo (N)
Okaw Arkitekter, Oslo
Flex-CC-Glass AS, Barkaker



WICLINE 65 evo
WICLINE 75 evo

 AXA Colonia / Cologne, Köln (D)
Van den Valentyn Architektur, Köln (D)
Beaujean Fassadentechnik, Leipzig (D)

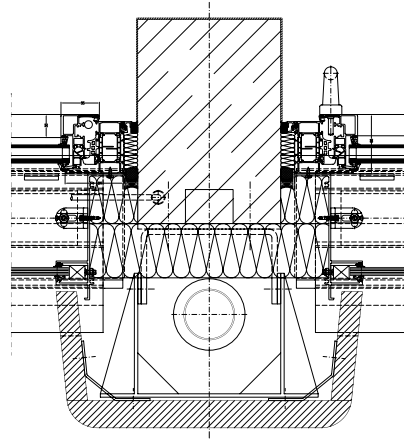

Lochfenster | Fensterbänder

Punched windows | ribbon windows

Funktion in Form

In ihrer klassischen Anwendung als Lochfenster oder Fensterbänder lassen sich mit WICLINE langlebige und energieeffiziente Fensterlösungen von Anfang an planen und ausführen. Auch für Sanierungen bieten die WICONA Systeme mit speziellen Profilgeometrien wie Klassik-Design oder Industrie-Design das passende Konzept. Aufgrund der hohen Variantenvielfalt, zahlreicher Formen und Öffnungsarten lassen sich WICLINE Fenster exakt an die individuelle Gebäudesituation und an die Wünsche der Kunden anpassen. Das gilt auch für zusätzliche Funktionen wie Einbruch- oder Durchschusshemmung – sie sind leicht zu integrieren, ohne die Fassadenoptik zu stören.

In der Wärmedämmung reicht die Bandbreite von der ungedämmten Profilvariante für Innenanwendungen bis hin zu Konstruktionen mit U_w -Werten von $0,75 \text{ W}/(\text{m}^2\text{K})$. Mit WICLINE 75 evo können bereits U-Werte auf Passivhausniveau erfüllt werden. In der Schweiz ist es das erste Metallfenster, das als Minergie-P-Modul die höchste Klassifizierung erreicht.



Function and form

The classic use of aluminium windows lies in the high-quality execution of punch windows or ribbon glazing. In new buildings, WICONA window solutions allow durable and energy-efficient solutions to be planned and executed from the outset. WICONA systems also offer a suitable concept for renovation projects. Thanks to the great variety, numerous shapes and types of opening, WICLINE windows can be specifically tailored to the individual building and wishes of the customer. This can be combined with special functions like burglar or bullet resistance – easy to integrate without changing the design.

Thermal insulation can be adapted from non-broken profiles for interior application to designs with U_w values down to $0.75 \text{ W}/(\text{m}^2\text{K})$. With WICLINE 75 evo you can already reach passive house level with a 75 mm construction. In Switzerland this is the first metal window which was certified as Minergie-P module, the most challenging classification in terms of insulation and quality.



Öffnungsarten | Beschläge
Opening types | fittings

1 | Dreh/Dreh-Kipp-/Kippfenster/Oberlicht

Die klassischen Öffnungsarten mit vielen Ausführungsvarianten und Design-Optionen wie z. B. Industrie-Design

2 | Schwing- und Wendefenster

Für jeden Gebäudetyp die passende Variante durch umfangreiches Programm an Beschlagsvarianten.

3 | Parallel-Schiebe-Kippfenster PSK

Bei dieser platzsparenden Öffnungsvariante lassen sich die Flügel kippen oder einfach zur Seite schieben.

4 | Klapp-/Senk-Klappfenster/Drehfenster auswärts öffnend

Effiziente Lüftung, schlanke Ansichten und hohe Wärmedämmung für die Öffnung nach außen.

5 | Lüftungsklappe

Wärmegeprägter Aluminium-Drehflügel zur manuell oder motorisch bedienbaren Lüftung. Ideal in Büro- und Hotelgebäuden.

6 | NRW (natürliche Rauch- und Wärmeabzugsgeräte)

Mehrere zugelassene Fenstervarianten für Fassade und Glasdach eröffnen bei NRW eine große Gestaltungsfreiheit.



Fenstervarianten
Window options

1 | Turn / turn-tilt / tilt windows / fanlights

The classic opening type with many variations and multiple design options like industrial design.

2 | Pivot windows vertical / horizontal

For each building the most suitable version due to a wide range of fittings.

3 | PSK Parallel sliding tilt window

In this space saving opening version the sash can be tilted or slid to the side with ease.

4 | Top-hung / Italian style windows / side-hung windows

Effective ventilation, slim frames and performing thermal insulation characterize these vents opening to the outside.

5 | Ventilation flap

Thermally insulated aluminium turn sash, for manual or motorized ventilation. Ideal for office and hotel buildings.

6 | Smoke control (NSHEVS)

Several window types with approval for curtain wall and skylight for a wide range of applications.

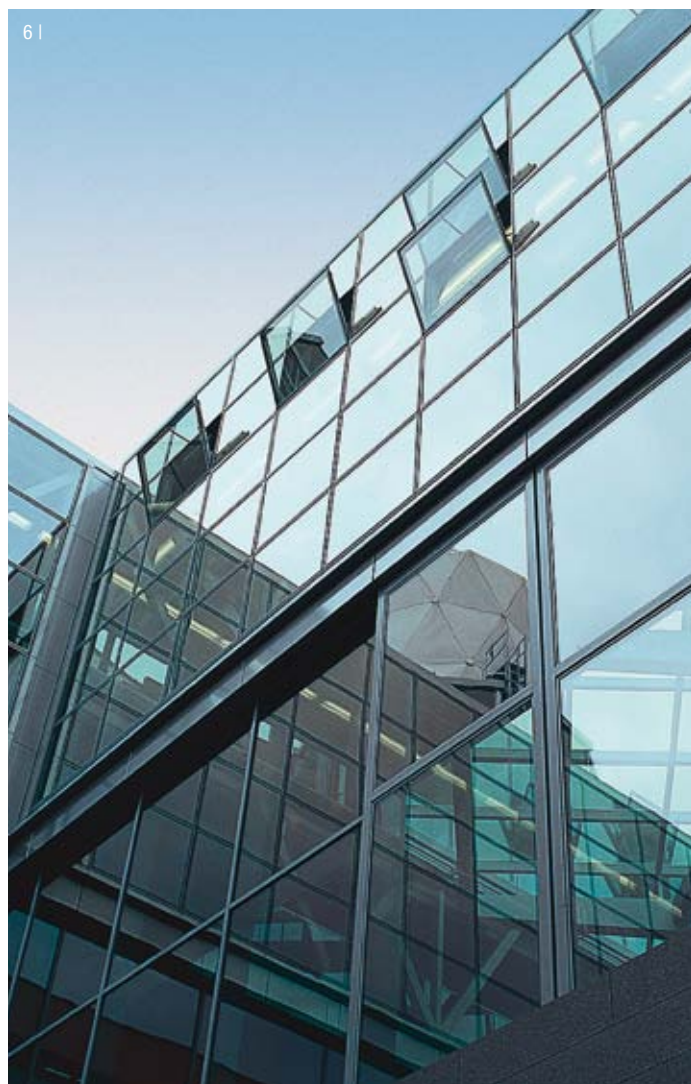

Designvarianten Design options

WICLINE evo Designvarianten

Aufgrund des WICONA Unisys Prinzips können die WICLINE evo Fenster in beiden Bautiefen, 65 und 75 mm, mit unterschiedlichen Profilkonturen an individuelle Designwünsche angepasst werden. Die Leistungseigenschaften, Funktionen und Öffnungsvarianten sind dabei immer auf höchstem Niveau.

WICLINE evo design options

Based on the unique WICONA Unisys technology with a wide range of different profile contours the WICLINE evo windows in both construction depths, 65 and 75 mm, can easily be adapted to individual design requirements. The performances, functions and opening types remain on the highest technical level.

11



Fenstervarianten
Window options

1 | Minergie-Fenster

Mit höchster Wärmedämmung $U_w \leq 0,8 \text{ W/(m}^2\text{K)}$

2 | Verdeckter Flügel

Extrem schlanke Ansichten für maximalen Lichtdurchlass und Panoramansicht. Sehr gute U_w -Werte aufgrund des optimierten Rahmen-Glas-Verhältnisses.

3 | Klassik-Design

Abgeschrägte Konturen und aufliegende Flügel schaffen eine optische Anmutung, die gerade im Wohnbereich ideal passt.

4 | Einsatzflügel

Die ideale Funktionserweiterung für alle Pfosten-Riegel- oder Elementfassaden, ausführbar als flächenbündiger oder verdeckter Flügel.

5 | Barrierefreie Schwelle

Ideal für großformatige Fenstertüren:

Eine wärmegeämmte, barrierefreie Schwelle ist ausführbar für Flügelgrößen bis 1,30 x 2,50 m einwärts öffnend und 1,10 x 2,25 m auswärts öffnend.

1 | Minergie window

With superior thermal insulation $U_w \leq 0.8 \text{ W/(m}^2\text{K)}$

2 | Concealed sash

Extremely slim frame for maximum light transmission and panoramic views. Very good U_w values due to optimized frame-glass ratio.

3 | Classic design

Bevelled profile contours and overlapping sashes offer a design which suits especially to residential properties.

4 | Integration sash

The ideal extension for all stick system or unitized curtain walls, available as standard or concealed sash.

5 | Barrier free threshold

Ideal for large format window doors:

A barrier free and thermally insulated threshold can be executed in sashes with a size up to 1.3 x 2.5 m (inward opening) and 1.1 x 2.25 m (outward opening)

2 |



3 |



4 |



5 |



WICLINE 65 evo
WICLINE 75 evo
WICLINE 90SG
WICTEC 50 Dachlüftungsflügel/sky light sash

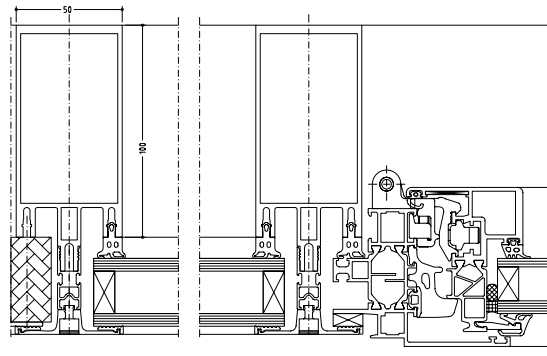

 Steckelhörn | Cogiton, Hamburg (D)
J. Mayer H., Berlin (D)
Rupert App, Leutkirch (D)



Einsatzfenster
Integration sashes

Funktion für Fassaden

So flexibel und variantenreich sich die WICTEC Fassadensysteme zeigen, so individuell lassen sich Öffnungselemente aus den Serien WICTEC und WICLINE in Glasfassaden und Glasdächer integrieren. Die präzise Abstimmung der Wärmedämmung, die schlanken Ansichten der Profilgeometrien mit speziellen Einspann-Blendrahmen, die freie Wahl aus einem äußerst umfangreichen Programm an Öffnungstypen – mit den WICLINE Fensterserien finden Sie für jeden Gestaltungsanspruch die perfekte Lösung.

Neben der optisch harmonischen Integration in die vorhandene Fassadenstruktur zeichnen sich WICONA Einsatzfenster durch ihre hohe Funktionalität aus. Es gibt Öffnungsmöglichkeiten nach innen und außen, die Bedienung kann manuell oder motorisch erfolgen. Verschiedene Systemvarianten ermöglichen die flexible Anpassung an die geforderten Wärmedämmkriterien.

Function for curtain walls

The flexibility and wide range offered by the WICTEC façade systems are perfectly matched by the individuality with which opening elements from the WICTEC and WICLINE ranges can be integrated into glass façades and skylights. Precise coordination of thermal insulation, narrow sight lines of profiles with special insertion frames, freedom to choose from an extremely wide range of opening types – with WICONA systems you will find the right solutions whatever your requirements.

Besides the homogeneous integration of the opening sashes into the building skin the WICONA window range stands out with its high functionality. The opening can be inward and outward, the operation can be manual or motorized. Various system options allow for the individual and gradual adaptation of the entire curtain wall to specific thermal values.

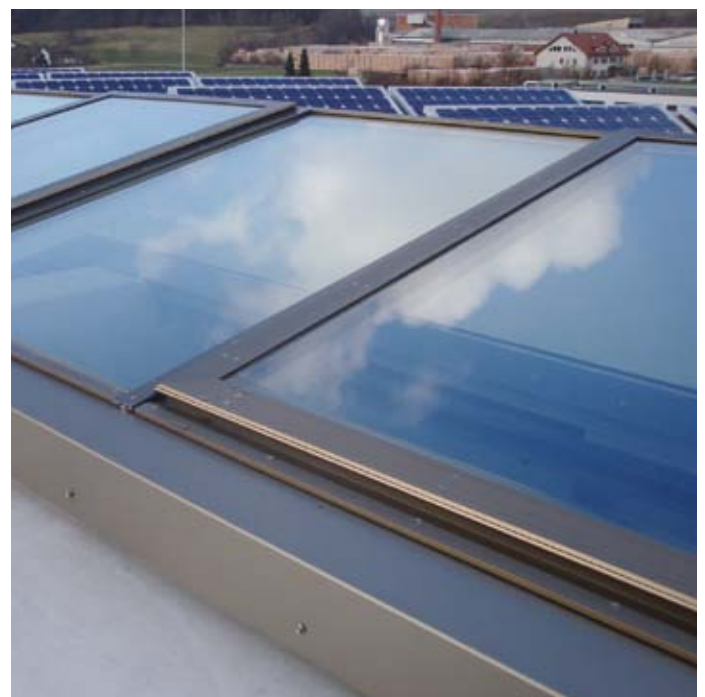

WICLINE 215

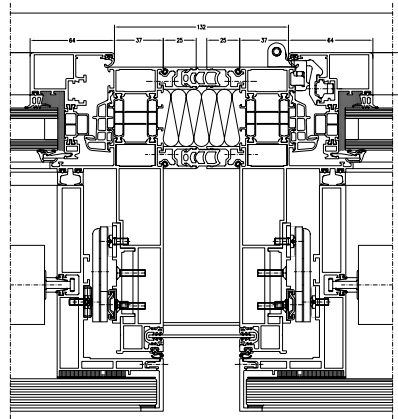

 Beluga Shipping GmbH, Bremen (D)
Haslob Kruse & Partner Architekten, Bremen (D)
Heinrich Würfel Metallbau, Sontra (D)



Hybridfenster Hybrid window

Komfort kombiniert

Das Hybridfenster WICLINE 215 ist die Innovation bei WICONA und verbindet einen inneren Dreh-Kippflügel mit einem äußeren Parallel-Abstellflügel. Es bietet bereits beim Einsatz mit Standardverglasung einen erhöhten Schallschutz: Je nach Verglasungstyp können Werte von 39 bis 57 dB erreicht werden. Selbst bei offener Fensterstellung senkt WICLINE 215 wirkungsvoll den Geräuschpegel von außen ab. Der integrierte Sonnenschutz überzeugt durch eine geringe Bautiefe und ist vor Schmutz und Witterungseinflüssen geschützt. Er schafft nicht nur ein angenehmes Raumklima, sondern optimiert auch spürbar den Energieverbrauch. Je nach Verglasungsart bietet die Hybrid-Technologie eine hohe Energieeffizienz mit U_w -Werten von 1,2 $W/(m^2K)$ bis 0,65 $W/(m^2K)$. Der innere Dreh-Kippflügel und der äußere Parallel-Abstellflügel sind unabhängig voneinander individuell zu öffnen und ermöglichen eine bedarfsgerechte Lüftung des Innenraumes. Dies schafft ein behagliches Raumklima und senkt den Energieeinsatz.

Combined for comfort

This hybrid window is the innovation within the WICONA window technology, combining an interior turn-tilt sash with an exterior parallel outward opening vent. Do you require a high level of sound protection even when your windows are open? WICONA has found a solution for an issue that at first appears irresolvable – with WICLINE 215. Depending on the glass type sound insulation values of 39 to 57 dB can be achieved. The slim integrated sun protection, perfectly protected between the sashes against pollution and weather conditions, improves the room climate whilst optimizing the energy consumption.

The hybrid technology of WICLINE 215 provides U_w values between 1.2 and 0.65 $W/(m^2K)$. The interior sash and the exterior parallel opening vent can be operated independently and lead to a perfectly adjustable ventilation of the building. The result: a significantly improved climate and a substantial reduction of energy cost.



WICLINE 125

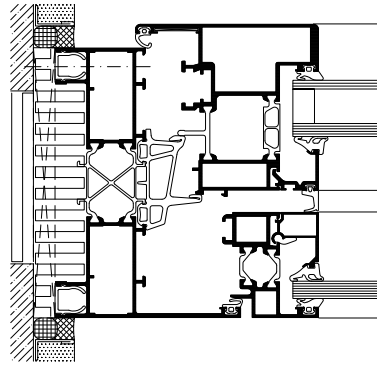

 AHS, Bonn (D)
DHBT Architekten, Kiel (D)
Hanse Metallbau, Rostock (D)



Verbundfenster *Coupled window*

Doppelt schützt besser

Wer ein Mehr an Schutz gegen Umwelteinflüsse benötigt, kann sich eine zusätzliche Haut zulegen: Bei den WICLINE 125 Verbundfensterkonstruktionen wird eine innere Fensterebene mit einem zusätzlich vorgesetzten Flügel kombiniert. Dadurch erhöhen sich die Schutzfunktion und damit der Nutzerkomfort deutlich. Optimierter Schallschutz bis 48 dB, maximierte Energieeinsparung durch erhöhte Wärmedämmung, größtmöglicher Bedienungskomfort, effiziente und schmutzgeschützte Integration von Sonnenschutzanlagen im Flügelzwischenraum: auch weitgehende technische Anforderungen kann ein WICONA Verbundfenster einfach erfüllen.

Twice the protection

WICLINE 125 is a composite window system for buildings with particularly high requirements when it comes to overall technical characteristics, above all sound insulation with up to 48 dB. One special feature is the insulating zone in the frame and the insulation in the inner and outer sash. Depending on the glazing used, you can achieve U_w values of less than $0.9 \text{ W}/(\text{m}^2\text{K})$. Sun protection devices can be integrated well protected between the outer and the inner pane.



Bharati Research Station
Auf den Spuren
Roald Amundsons
Bharati Research Station
on Roald Amundson's
traces

» Bharati

- ✎ NCAOR, Goa (India)
- IMS Ingenieurgesellschaft, Hamburg (D)
- bof Architekten, Hamburg (D)
- Käfer Construction, Bremen (D)
- Lenderoth GmbH, Bremen (D)



Die Idee der indischen Regierung war, eine Forschungsstation in der Antarktis zu installieren. Die Idee des Architekten war, die Sicherheitsaspekte und die extremen bauphysikalischen Anforderungen an die Gebäudehülle mit einem Panoramablick auf die Polarregion zu verbinden. Die Idee des Ingenieurbüros war, die Station aus über 130 vormontierten Containern zusammenzustellen, mit einer zusätzlichen Außenhülle zu versehen und damit die erforderliche kurze Montagezeit zu ermöglichen.

Entwicklungsdetails und Konstruktion der Fassade orientierten sich an den extremen Wetterbedingungen der Südpolregion. Thermische und mechanische Belastungen durch Blizzards mit riesigen Schneemengen und Windgeschwindigkeiten bis 270 km/h sowie Temperaturen von -40 °C und darunter stellen höchste Anforderungen an das Material. Der Glasfassadenteil des Komplexes besteht aus einer speziell modifizierten Pfosten-Riegel-Konstruktion und dreifach isolierten Glaselementen mit einer 15°-Neigung an der Nord- und Südseite. Basis hierfür sind die WICONA Systeme WICTEC 50 HI und WICLINE 75, jeweils in der HI (High-Insulated)-

Version. Mit diesem Aufbau erreicht die Fassade einen U_{cw} -Wert von 0,8 W/(m²K).

Bei den Container-Innenelementen stand das Thema Feuerschutz im Vordergrund. Brandschutztüren (T30) und -Lochfenster (F30) mit Drehflügeln auf Basis der WICONA Systeme WICLINE 75 und WICSTYLE 77, jeweils in der Version FP (Fire-Protected), konnten hier die passende Lösung aus dem Serienportfolio bieten.

Die Bharati Forschungsstation demonstriert beispielhaft, wie auch unter extremen Anforderungen durch ein enges Zusammenspiel aller Baubeteiligten aus Ideen gebaute Wirklichkeit wird.

The Indian government's idea was to set up a research station in the Antarctic. The architect's idea was to align the safety aspects and the extreme structural requirements given to the building envelope, with a panoramic view out onto the Polar region. The engineering firm's idea was to build the station using over 130 prefabricated containers and add an extra outer envelope, whilst meeting the tight assembly deadline. The extreme weather conditions in the

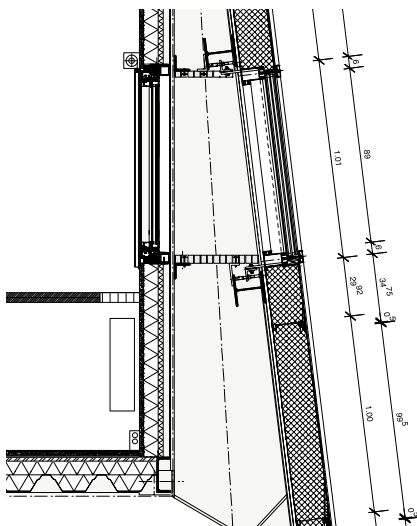



South Pole region dictated the development details and façade construction. Enormous demands were placed on the material owing to the thermal and mechanical loads caused by blizzards bringing extremely heavy snowfalls, wind speeds of up to 270 km/h and temperatures of -40 °C and below. The glass façade part of the complex features a specially modified mullion-transom construction and triple-insulated glass elements with a 15° incline on the north-south side. The WICTEC 50 HI and WICLINE 75 WICONA systems (high-insulated versions) formed the basis. With this structure, the façade attains a U_{cw} value of 0.8 W/(m²K). Fire protection was a primary concern when designing the container's internal elements. Fire-protection doors (T30) and punch windows (F30) with turning sashes based on the WICLINE 75 and WICSTYLE 77 WICONA systems (fire-protected versions) provided the appropriate solution from the range portfolio. The Bharati Research Station demonstrates admirably how close team work among all those involved with construction ensures that ideas become reality – even under the most arduous conditions.



22
23

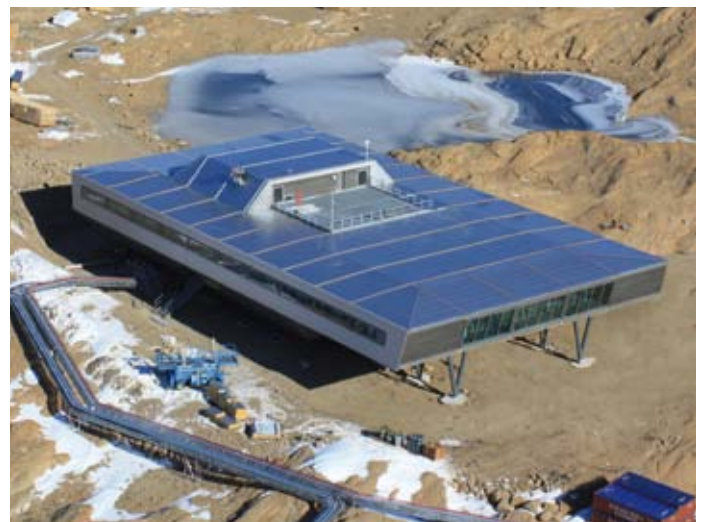
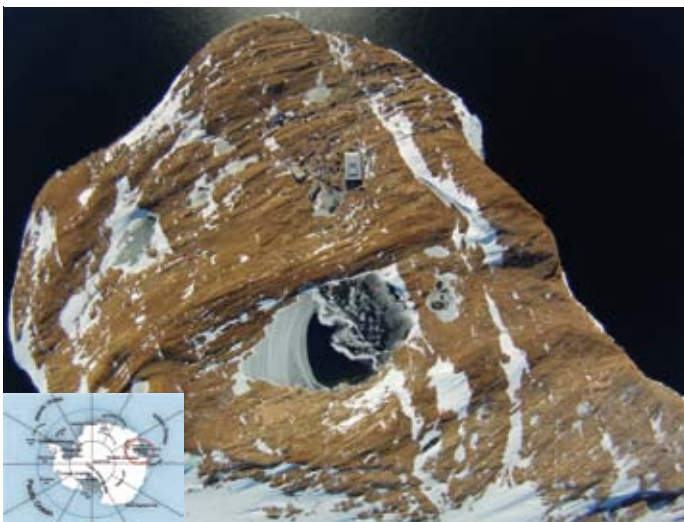

Energieautarker Bergkristall
Self-sufficient mountain crystal

» Monte Rosa

An exponierter Lage auf 2883 m, über dem Monte Rosa-Gletscher, wurde ein Meilenstein für das hochalpine Bauen gesetzt. Die Idee war, mit der neuen Monte Rosa Hütte ein Bauprojekt mit Vorbildcharakter im Bereich Energie- und Ressourceneffizienz, mit einer Energieautarkie von über 90 %, zu schaffen. WICONA hat mit der Integration der Photovoltaik auf der Südfassade sowie mit dem um das Gebäude laufenden Fenster-Lichtband mit höchster Wärmedämmung einen wesentlichen Beitrag dazu geleistet. Die neue Monte Rosa Hütte insgesamt ist nach Minergie-P zertifiziert. Rund 84 m² misst die in die Südfassade des Gebäudes mittels einer WICTEC Pfosten-Riegel-Fassade integrierte Photovoltaikanlage. Die komplexe Geometrie des „Bergkristalls“ in 11 Facetten und 8 unterschiedlichen Neigungen stellte für die Konstruktion des Lichtbandes eine sehr große Herausforderung dar. Die Elemente als Pfosten-Riegel-Fassade mit integrierten WICLINE Einsatzflügeln in

Monte Rosa Hütte/Monte Rosa Hut, Zermatt (CH)
Andrea Deplazes/ETH Zürich (CH)
Fuxvisp AG, Visp (CH)

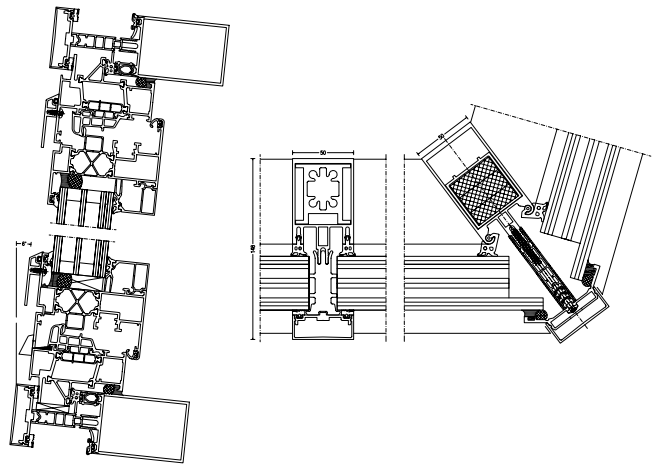
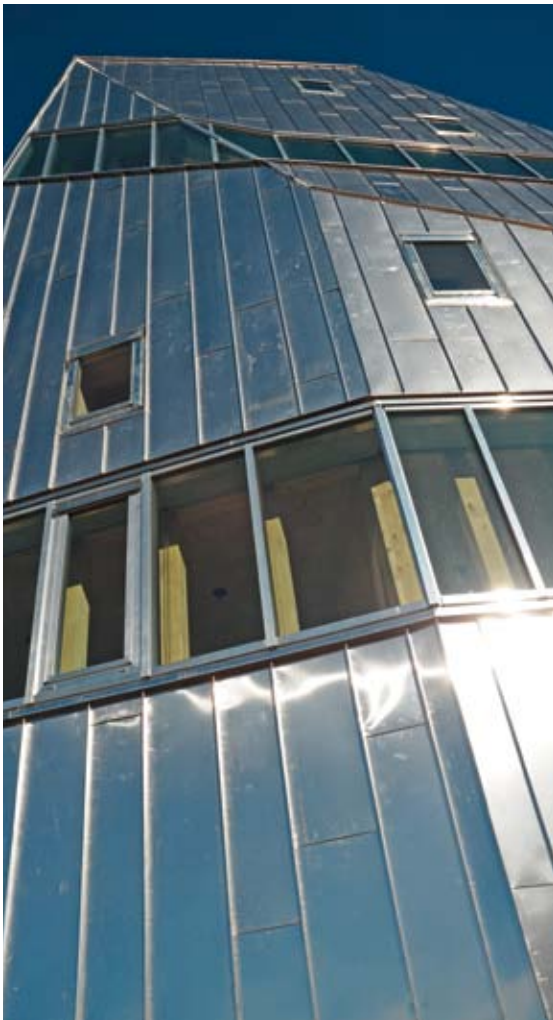

der Ausführung mit höchster Wärmedämmung folgen den verschiedenen Facetten, welche zueinander unterschiedliche Neigungen und beliebige Eckwinkel aufweisen. Zusätzlich windet sich das Lichtband um das Gebäude kontinuierlich in die Höhe. So charakteristisch für das Interieur der Monte Rosa Hütte ihre massive Holzkonstruktion ist, so signifikant ist dies für die Aussenseite die vollflächige Verkleidung aus rohem Aluminium. Dieser Werkstoff, der ebenfalls für die Fenster gewählt wurde, ist wartungsfrei, verfügt über eine sehr lange Lebensdauer, ist wertbeständig und widerstandsfähig, trotz hoher Beanspruchung und ist 100 % recyclebar.

In a very special location above the Monte Rosa glacier, in an altitude of 2883 m, a new milestone for alpine building was set. The idea for the new Monte Rosa hut was to achieve a building with exemplary character in terms of energy and resource management,

with an energy self sufficiency of more than 90 %. WICONA participated to a big part by the constructions for the integration of the photovoltaic panels and the ribbon windows in highest thermal insulation. The new Monte Rosa hut has been certified a Minergie-P building. 84 sqm of photovoltaic panels are installed in a WICTEC stick construction, being the only rectangular part of the edifice. The complex geometry of the "mountain crystal" with 11 facets and 8 varying inclinations meant a big challenge especially for the realization of the window ribbon. The units with the WICLINE sashes in highest thermal insulation run around the building and follow the facets and inclinations, with differing angles each. The interior of the hut is kept in wood, whereas the exterior is completely in aluminium, as are the curtain wall and windows, following the idea of maximum energy and resource efficiency. This material is maintenance free, long lasting and weather resistant, and can be recycled entirely.



WICLINE 65 evo
Dreh-/ Dreh-Kipp-/ Kippfenster
Stulpflügel Fenster
Tilt-First-Fenster
Oberlicht

Die hoch entwickelte Technik und das umfangreiche Profilprogramm machen das Aluminiumfenster WICLINE 65 evo zum perfekten Allrounder mit vielseitigem Anwendungsspektrum.

Bereits mit 65 mm Bautiefe erfüllt das System hohe Anforderungen an Wärme- und Schallschutz. Dadurch bietet WICLINE 65 evo ein besonders günstiges Preis-Leistungs-Verhältnis.

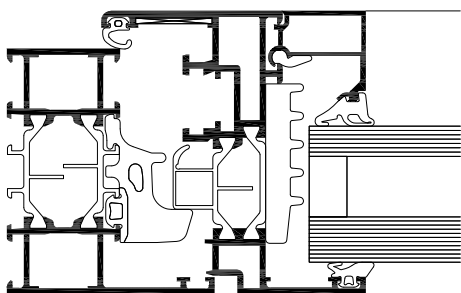

Systemprüfungen / CE-Produktpass
nach DIN EN 14351-1:2006+A1:2010

Luftdurchlässigkeit:	Klasse 4
Schlagregendichtheit:	E900
Widerstandsfähigkeit gegen Windlast:	Klasse C5/B5
Schallschutz:	$R_w(C;C_{tr}) = 47 (-1;-4)$ dB
Bedienkräfte:	Klasse 1
Tragfähigkeit von Sicherheitsvorkehrungen:	erfüllt
Mechanische Festigkeit:	Klasse 4
Dauerfunktion:	Klasse 3 (20.000 Zyklen)
Korrosionsbeständigkeit der Beschläge:	Klasse 5
Einbruchhemmung:	RC1N, RC2N, RC2, RC3
Durchschusshemmung:	FB4 S, FB4 NS (abhängig von Profilkombinationen)
Qualitätsmanagement:	Zertifiziert nach DIN EN ISO 9001:2008



Technische Leistungen:

Profiltechnik:

- Hoch wärmedämmtes Mehrkammersystem mit symmetrischem Aufbau, qualitätsgesichert im Werksverbund hergestellt
- Patentierte Eck- und Stoßverbindertechnik für hohe Bauteilfestigkeit
- Füllungsdicken bis 59 mm

Wärmeschutz:

- U_f -Werte: bis 1,4 W/(m²K)
- U_w -Werte: bis 0,93 W/(m²K) mit Dreifachglas

Dichtungskonzept:

- Großvolumige Mitteldichtung in drei Varianten:
 - Umlaufender Einbau ohne Stoß im Eckbereich
 - Mit Formecken, ohne Verklebung der Stöße
 - Eckvulkanisierte Rahmen

Beschläge:

- Verdeckt liegende Einhandbeschläge, wahlweise mit:
 - Aufliegenden Bändern, farbig beschicht- oder eloxierbar
 - Verdeckt liegenden Bändern mit integrierter Endlagendämpfung, Öffnungswinkel max. 105°
- Flügelgewichte:
 - Verdeckt liegende Bänder: bis 160 kg
 - Aufliegende Bänder: bis 200 kg
 - Auf Anfrage: bis 300 kg
- Flügelformate B x H: bis 1.700 x 2.500 mm, Oberlicht bis 2.500 x 1.700 mm
- Wahlweise mit Öffnungsbegrenzer in verschiedenen Varianten

Weitere Ausführungen:

- Verdeckter Flügel
- Klassik-Design
- Einspannrahmen für Pfosten-Riegel-Fassaden
- Oberlicht mit Handhebel, Gelenkkurbel oder Motor
- Schwing- / Wendefenster
- Parallel-Schiebe-Kippfenster, mit oder ohne Zwangssteuerung
- Senk-Klappfenster auswärts öffnend
- Klapp-/Drehfenster auswärts öffnend
- 1- und 2-flügelige Fenstertüren einwärts und auswärts öffnend mit barrierefreier Schwelle
- Einbruchhemmung (siehe Systemprüfungen)
- Durchschusshemmung (siehe Systemprüfungen)

Kompatibel mit den Türserien

WICSTYLE 65 evo und WICSTYLE 75 evo

WICLINE 75 evo
Dreh-/ Dreh-Kipp-/ Kippfenster
Stulpflügelfenster
Tilt-First-Fenster
Oberlicht
Minergie-P-Modul Fenster

Mit 75 mm Bautiefe stellt sich WICLINE 75 evo an die Spitze der Wärmedämmeigenschaften und bauphysikalischen Merkmale. Mit höchsten Leistungseigenschaften ist dieses Aluminiumfenster auf alle zukünftigen Anforderungen der Architektur ideal abgestimmt. In der Schweiz wurde WICLINE 75 evo als erstes Metallfenster als Minergie-P-Modul zertifiziert.

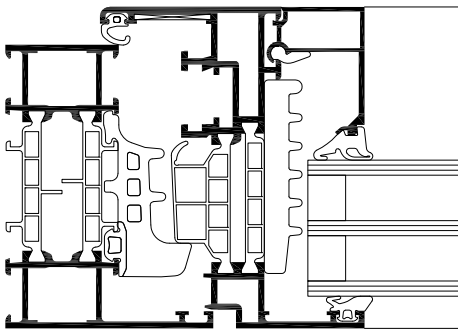

Systemprüfungen/ CE-Produktpass
nach DIN EN 14351-1:2006+A1:2010

Luftdurchlässigkeit:	Klasse 4
Schlagregendichtheit:	E900
Widerstandsfähigkeit gegen Windlast:	Klasse C5/B5
Schallschutz:	$R_w (C;C_{tr}) = 47 (-1;-4)$ dB
Bedienkräfte:	Klasse 1
Tragfähigkeit von Sicherheitsvorkehrungen:	erfüllt
Mechanische Festigkeit:	Klasse 4
Dauerfunktion:	Klasse 3 (20.000 Zyklen)
Korrosionsbeständigkeit der Beschläge:	Klasse 5
Einbruchhemmung:	RC1N, RC2N, RC2, RC3
Durchschusshemmung:	FB4 S, FB4 NS (abhängig von Profilkombinationen)
Qualitätsmanagement:	Zertifiziert nach DIN EN ISO 9001:2008



Technische Leistungen:

Profiltechnik:

- Hoch wärmegeädmmtes Mehrkammersystem mit symmetrischem Aufbau, qualittsgesichert im Werksverbund hergestellt
- Patentierte Eck- und Stoverbindertechnik fr hohe Bauteilfestigkeit
- Fllungsdicken bis 69 mm

Wrmeschutz:

- U_f -Werte: bis 1,2 W/(m²K)
- U_w -Werte: bis 0,87 W/(m²K) bei Flgel, bis 0,72 W/(m²K) bei Festverglasungen, mit Dreifachglas
- Zertifiziert als Minergie-P-Modul Fenster mit $U_w \leq 0,8$ W/(m²K) als Stulpfenster

Dichtungskonzept:

- Grovolumige Mitteldichtung in drei Varianten:
 - Umlaufender Einbau ohne Sto im Eckbereich
 - Mit Formecken, ohne Verklebung der Stoe
 - Eckvulkanisierte Rahmen

Beschlge:

- Verdeckt liegende Einhandbeschlge, wahlweise mit:
 - Aufliegenden Bndern, farbig beschicht- oder eloxierbar
 - Verdeckt liegenden Bndern mit integrierter Endlagendmpfung, ffnungswinkel max. 105°
- Flgelgewichte:
 - Verdeckt liegende Bnder: bis 160 kg
 - Aufliegende Bnder: bis 200 kg
 - Auf Anfrage: bis 300 kg
- Flgelformate B x H: bis 1.700 x 2.500 mm, Oberlicht bis 2.500 x 1.700 mm
- Wahlweise mit ffnungsbegrenzer

Weitere Ausfhrungen:

- Verdeckter Flgel
- Klassik-Design
- Einspannrahmen fr Pfosten-Riegel-Fassaden
- Oberlicht mit Handhebel, Gelenkkurbel oder Motor
- Schwing-/Wendefenster
- Parallel-Schiebe-Kippfenster, mit oder ohne Zwangssteuerung
- Senk-Klappfenster auswrts ffnend
- Klapp-/Drehfenster auswrts ffnend
- 1- und 2-flgelige Fensterturen einwrts und auswrts ffnend mit barrierefreier Schwelle
- Einbruchhemmung (siehe Systemprfungen)
- Durchschusshemmung (siehe Systemprfungen)

Kompatibel mit den Trserien
WICSTYLE 65 evo und WICSTYLE 75 evo

**WICLINE 65 evo / WICLINE 75 evo
Verdeckter Flügel**

Bei der Variante Verdeckter Flügel des Aluminium-Fenstersystems WICLINE evo wird die Verglasung durch eine spezielle Glasleiste direkt im Dämmsteg gehalten. Extrem schlanke Rahmenansichten mit gleichzeitig sehr guten Dämmwerten und fugenfreie Rahmenansichten von außen werden so erreicht. Das verbesserte Verhältnis zwischen Rahmen- und Verglasungsanteil ermöglicht sehr gute U_w -Werte und einen erhöhten Lichtdurchlass mit Panoramablick.

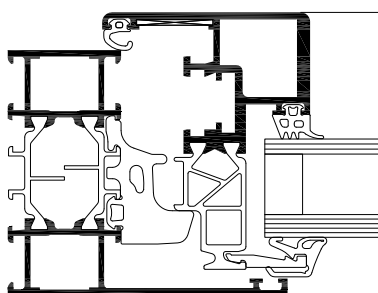
**Systemprüfungen / CE-Produktpass
nach DIN EN 14351-1:2006+A1:2010**

Luftdurchlässigkeit:	Klasse 4
Schlagregendichtheit:	E1200
Widerstandsfähigkeit gegen Windlast:	Klasse C5 / B5
Bedienungskräfte:	Klasse 1
Tragfähigkeit von Sicherheitsvorkehrungen:	erfüllt
Mechanische Festigkeit:	Klasse 4
Dauerfunktion:	Klasse 2 (10.000 Zyklen)
Stoßfestigkeit:	Klasse 3
Einbruchhemmung:	RC1N, RC2N, RC2, RC3
Qualitätsmanagement:	Zertifiziert nach DIN EN ISO 9001:2008

Technische Leistungen:
Profiltechnik:

- Hoch wärmegeädämmtes Mehrkammersystem mit symmetrischem Aufbau, qualitätsgesichert im Werksverbund hergestellt
- Patentierte Eck- und Stoßverbindertechnik für hohe Bauteilfestigkeit
- Füllungsdicken bis 42 mm
- Optional mit Einspannblendrahmen für Integration in Pfosten-Riegel-Fassaden

Wärmeschutz:

- U_f -Werte: bis 1,5 W/(m²K)
- U_w -Werte: bis 0,94 W/(m²K) Dreifachglas

Dichtungskonzept:

- Großvolumige Mitteldichtung in drei Varianten:
 - Umlaufender Einbau ohne Stoß im Eckbereich
 - Mit Formecken, ohne Verklebung der Stöße
 - Eckvulkanisierte Rahmen

Beschläge:

- Verdeckt liegende Einhandbeschläge, wahlweise mit:
 - aufliegenden Bändern, farbig beschicht- oder eloxierbar
 - verdeckt liegenden Bändern mit integrierter Endlagendämpfung, Öffnungswinkel 105°
- Flügelgewichte:
 - bis 130 kg
- Flügelformate B x H: bis 1.300 x 2.250 mm
- Wahlweise mit Öffnungsbegrenzer in verschiedenen Varianten

Weitere Ausführungen als Verdeckter Flügel:

- Einspannrahmen für Pfosten-Riegel-Fassaden
- Oberlicht
- Schwing-/Wendefenster
- Einbruchhemmung (siehe Systemprüfungen)

**WICLINE 65 evo / WICLINE 75 evo
Klassik-Design**



Abgeschrägte Konturen und ein Flächenversatz durch aufliegende Flügel verleihen der Aluminium-Fensterserie WICLINE evo im Klassik-Design eine optische Gestaltungslinie, die ein in der Wohnbauarchitektur häufig angestrebtes Ambiente unterstreicht. Ideal sowohl im Neubaubereich wie auch bei energetischen Sanierungen.

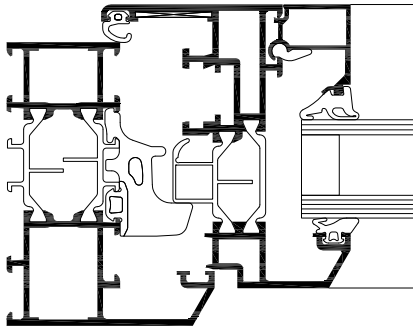

**Systemprüfungen / CE-Produktpass
nach DIN EN 14351-1:2006+A1:2010**

Luftdurchlässigkeit:	Klasse 4
Schlagregendichtheit:	E900
Widerstandsfähigkeit gegen Windlast:	Klasse C5/B5
Schallschutz:	$R_w (C;C_{tr}) = 47 (-1;-4)$ dB
Bedienkräfte:	Klasse 1
Tragfähigkeit von Sicherheitsvorkehrungen:	erfüllt
Mechanische Festigkeit:	Klasse 4
Dauerfunktion:	Klasse 3 (20.000 Zyklen)
Korrosionsbeständigkeit der Beschläge:	Klasse 5
Einbruchhemmung:	RC1N, RC2N, RC2, RC3
Qualitätsmanagement:	Zertifiziert nach DIN EN ISO 9001:2008

Technische Leistungen:

Profiltechnik:

- Hoch wärmegeädmmtes Mehrkammersystem mit symmetrischem Aufbau, qualitätsgesichert im Werksverbund hergestellt, mit 30° abgeschrägten Glasfälen
- Patentierte Eck- und Stoßverbindertechnik für hohe Bauteilfestigkeit
- Füllungsdicken bis 59 mm

Wärmeschutz:

- U_f -Werte: bis 1,5 W/(m²K)
- U_w -Werte: bis 0,84 W/(m²K) mit Dreifachglas

Dichtungskonzept:

- Großvolumige Mitteldichtung in drei Varianten:
 - Umlaufender Einbau ohne Stoß im Eckbereich
 - Mit Formecken, ohne Verklebung der Stöße
 - Eckvulkanisierte Rahmen

Beschläge:

- Verdeckt liegende Einhandbeschläge, wahlweise mit:
 - aufliegenden Bändern, farbig beschicht- oder eloxierbar
 - verdeckt liegenden Bändern mit integrierter Endlagendämpfung, Öffnungswinkel max. 105°
- Flügelgewichte:
 - Verdeckt liegende Bänder: bis 100 kg
 - Aufliegende Bänder: bis 100 kg
- Flügelformate B x H: bis 1.300 x 1.700 mm
- Wahlweise mit Öffnungsbegrenzer in verschiedenen Varianten

Weitere Ausführungen in Klassik-Design:

- Flächenbündiger Flügel in Klassik-Design
- Flügel und Rahmen in Klassik-Design
- Festverglasung
- Stulpfenster
- Sprossenprofile und Ziersprossen
- Spannrahmen für Pfosten-Riegel-Fassaden
- Oberlicht
- Einbruchhemmung (siehe Systemprüfungen)

Kompatibel mit den Türserien WICSTYLE 65 evo und WICSTYLE 75 evo in Klassik-Design

WICLINE 65 evo / WICLINE 75 evo
Fenstertür, barrierefrei

Mit maximierten Fensterformaten und barrierefreier Schwelle erweitert diese einwärts oder auswärts öffnende Aluminium-Fenstertür die Gestaltungsfreiheit. Hohe technische Leistungswerte und vorbildliche Wärmedämmung setzen neue Zeichen.

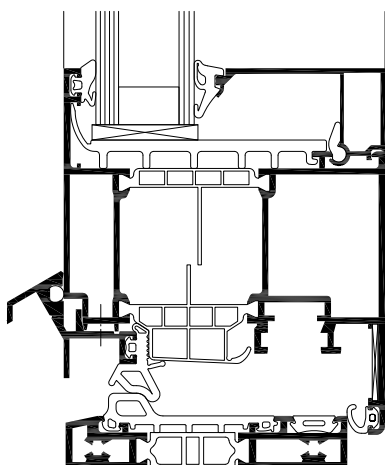
Systemprüfungen / CE-Produktpass
nach DIN EN 14351-1:2006+A1:2010

	Einwärts öffnend:	Auswärts öffnend:
Luftdurchlässigkeit:	Klasse 4	Klasse 4
Schlagregendichtheit:	Bis E900	7A
Widerstandsfähigkeit gegen Windlast:	Bis Klasse C5/B5	Klasse C3/B3
Bedienkräfte:	Klasse 1	Klasse 1
Mechanische Festigkeit:	Klasse 4	Klasse 4
Dauerfunktion:	Klasse 2 (10.000 Zyklen)	Klasse 2 (10.000 Zyklen)
Qualitätsmanagement:	Zertifiziert nach DIN EN ISO 9001:2008	

Technische Leistungen:
Profiltechnik:

- Hoch wärmegeädämmtes Mehrkammersystem mit symmetrischem Aufbau, qualitätsgesichert im Werksverbund hergestellt
- Patentierte Eck- und Stoßverbindertechnik für hohe Bauteilfestigkeit
- Füllungsdicken bis 69 mm
- Optional: Barrierefreie, wärmegeädämmte Schwelle

Wärmeschutz:

- U_f -Werte: bis 1,3 W/(m²K)

Dichtungskonzept:

- Großvolumige Mitteldichtung in drei Varianten:
 - Umlaufender Einbau ohne Stoß im Eckbereich
 - Mit Formecken, ohne Verklebung der Stöße
 - Eckvulkanisierte Rahmen dreiseitig

Beschläge:

- Wahlweise einwärts oder auswärts öffnend
- Einflügelige oder zweiflügelige Ausführung möglich
- Verdeckt liegende Einhandbeschläge, mit aufliegenden Bändern, farbig beschicht- oder eloxierbar, bei einwärts öffnender Ausführung
- Flügelgewichte:
 - Bis 130 kg
- Flügelformate B x H:
 - Einwärts öffnend bis 1.400 x 2.500 mm,
 - auswärts öffnend bis 1.300 x 2.250 mm
- Wahlweise mit Öffnungsbegrenzer in verschiedenen Varianten

Kompatibel mit den Türserien
WICSTYLE 65 evo und WICSTYLE 75 evo

**WICLINE 65 evo / WICLINE 75 evo
PSK Parallel-Schiebe-Kippfenster**

Bei dieser platzsparenden Öffnungsvariante lassen sich die Flügel kippen oder einfach zur Seite schieben. Hoher Bedienfortschritt, variable Lüftungsstellung ohne störenden Flügel und hohe technische Leistungswerte kennzeichnen diese Variante des WICLINE evo Aluminium-Fenstersystems.

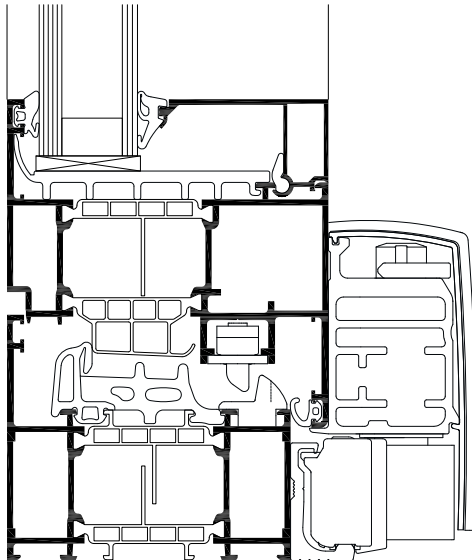

**Systemprüfungen / CE-Produktpass
nach DIN EN 14351-1:2006+A1:2010**

Luftdurchlässigkeit:	Klasse 4
Schlagregendichtheit:	E750
Widerstandsfähigkeit gegen Windlast:	Klasse C5/B5
Bedienkräfte:	Klasse 1
Mechanische Festigkeit:	Klasse 4
Dauerfunktion:	Klasse 2 (10.000 Zyklen)
Qualitätsmanagement:	Zertifiziert nach DIN EN ISO 9001:2008



Technische Leistungen:

Profiltechnik:

- Hoch wärmegeädmmtes Mehrkammersystem mit symmetrischem Aufbau, qualitäts-gesichert im Werksverbund hergestellt
- Patentierte Eck- und Stoßverbindertechnik für hohe Bauteilfestigkeit
- Füllungsdicken bis 69 mm

Wärmeschutz:

- U_f -Werte: bis 1,2 W/(m²K)

Dichtungskonzept:

- Großvolumige Mitteldichtung mit Ausführung als eckvulkanisierter Rahmen

Beschläge:

- PSK Parallel-Schiebe-Kippbeschlag, wahlweise
 - ohne Zwangssteuerung (OZ) oder
 - mit Zwangssteuerung (MZ)
- Flügelgewichte:
 - bis 160 kg (OZ)
 - bis 200 kg (MZ)
- Flügelformate B x H:
 - bis 1.685 x 2.500 mm (OZ)
 - bis 2.000 x 2.700 mm (MZ)

Kompatibel mit den Türserien

WICSTYLE 65 evo und WICSTYLE 75 evo

WICLINE 65 evo / WICLINE 75 evo Klappfenster / Drehfenster Auswärts öffnend

Die Flügelöffnung nach außen bietet häufig wesentliche Vorteile: Effiziente Lüftung, kein störender Flügel im Rauminneren, manuelle oder motorisierte Bedienung. Mit sehr großformatigen möglichen Flügelmaßen und optimierten Funktionen bietet WICLINE evo in dieser Ausführung eine sehr interessante Alternative für die Architektur.

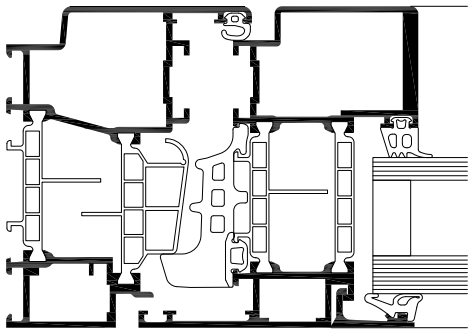

Systemprüfungen / CE-Produktpass nach DIN EN 14351-1:2006+A1:2010

Luftdurchlässigkeit:	Klasse 4
Schlagregendichtheit:	E1200
Widerstandsfähigkeit gegen Windlast:	Klasse C5/B5
Bedienkräfte:	Klasse 1
Tragfähigkeit von Sicherheitsvorkehrungen:	erfüllt
Mechanische Festigkeit:	Klasse 4
Dauerfunktion:	Klasse 2 (10.000 Zyklen)
Stoßfestigkeit:	Klasse 3
Qualitätsmanagement:	Zertifiziert nach DIN EN ISO 9001:2008



Technische Leistungen:

Profiltechnik:

- Hoch wärmegeädämmtes Mehrkammersystem mit symmetrischem Aufbau, qualitätsgesichert im Werksverbund hergestellt
- Patentierte Eck- und Stoßverbindertechnik für hohe Bauteilfestigkeit
- Füllungsdicken bis 69 mm
- Optional mit Einspannblendrahmen für Integration in Pfosten-Riegel-Fassaden

Wärmeschutz:

- U_f -Werte: bis 1,5 W/(m²K)
- U_w -Werte: bis 0,94 W/(m²K) mit Dreifachglas

Dichtungskonzept:

- Großvolumige Mitteldichtung in drei Varianten:
 - Umlaufender Einbau ohne Stoß im Eckbereich
 - Mit Formecken, ohne Verklebung der Stöße
 - Eckvulkanisierte Rahmen

Beschläge:

- Außenseitig aufliegende Bänder, wahlweise
 - oberseitige Befestigung für Klappfunktion
 - seitliche Befestigung für Drehfunktion
- Bedienung wahlweise manuell oder motorisch
- Flügelgewichte: bis 150 kg
- Flügelformate B x H: bis 2.000 x 2.000 mm



WICLINE 65 evo / WICLINE 75 evo Senk-Klappfenster Auswärts öffnend

Ein elegantes Erscheinungsbild gepaart mit einer effizienten Lüftung kennzeichnen das Aluminium-Fenstersystem WICLINE evo in der Ausführung als Senk-Klappfenster. Verdeckt liegende Senk-Klapp-Scheren ermöglichen die Öffnung auswärts auch für großflächige Flügel. Spezielle Rahmenprofile für Lochfenster oder Einsatzflügel und verschiedene Scherengrößen sorgen für maximale Flexibilität.

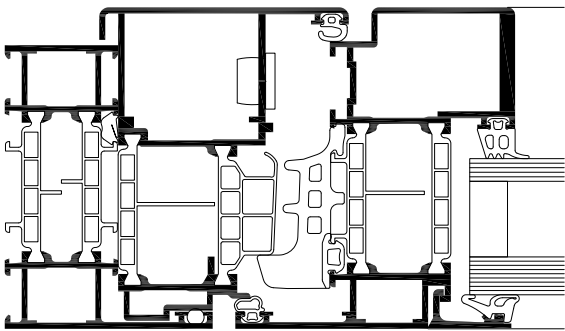

Systemprüfungen / CE-Produktpass nach DIN EN 14351-1:2006+A1:2010

Luftdurchlässigkeit:	Klasse 4
Schlagregendichtheit:	E1200
Widerstandsfähigkeit gegen Windlast:	Klasse C5/B5
Bedienkräfte:	Klasse 1
Mechanische Festigkeit:	Klasse 4
Dauerfunktion:	Klasse 2 (10.000 Zyklen)
Stoßfestigkeit:	Klasse 3
Qualitätsmanagement:	Zertifiziert nach DIN EN ISO 9001:2008



Technische Leistungen:

Profiltechnik:

- Hoch wärmedämmtes Mehrkammersystem mit symmetrischem Aufbau, qualitätsgesichert im Werksverbund hergestellt
- Patentierte Eck- und Stoßverbindertechnik für hohe Bauteilfestigkeit
- Füllungsdicken bis 69 mm
- Optional mit Einbaurahmen für Integration in Pfosten-Riegel-Fassaden

Wärmeschutz:

- U_f -Werte: bis 1,5 W/(m²K)
- U_w -Werte: bis 1,0 W/(m²K) mit Dreifachglas

Dichtungskonzept:

- Großvolumige Mitteldichtung mit sicherer Verarbeitung durch Formecken

Beschläge:

- Verdeckt integrierte Senk-Klapp-Scheren, mit Höhenverstellung
- Bedienung wahlweise manuell oder motorisch
- Flügelgewichte: bis 150 kg
- Flügelformate B x H: bis 2.000 x 2.200 mm

**WICLINE 65 evo / WICLINE 75 evo
Schwingfenster / Wendefenster**

Ein Klassiker unter den Öffnungsvarianten wird mit WICONA Technologie wieder zum topaktuellen Produkt: Die Schwingfenster und die Wendefenster auf Basis der Aluminium-Fensterserie WICLINE evo bieten höchste Wärmedämmung, sind jeweils bei CE-Systemtests in hohen Klassen zertifiziert und optisch mit aufliegenden oder verdeckten Lagern ein echtes Highlight für jedes Lochfenster oder die Pfosten-Riegel-Fassade.

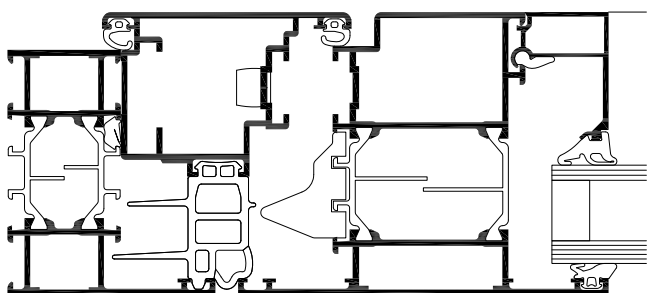
**Systemprüfungen / CE-Produktpass
nach DIN EN 14351-1:2006+A1:2010**

	Schwing	Wende
Luftdurchlässigkeit:	Klasse 4	Klasse 4
Schlagregendichtheit:	E750	4A
Widerstandsfähigkeit gegen Windlast:	Klasse C5/B5	Klasse C5/B5
Bedienkräfte:	Klasse 1	Klasse 1
Mechanische Festigkeit:	Klasse 4	Klasse 4
Dauerfunktion:	Klasse 2 (10.000 Zyklen)	Klasse 2 (10.000 Zyklen)
Qualitätsmanagement:	Zertifiziert nach DIN EN ISO 9001:2008	

Technische Leistungen:
Profiltechnik:

- Hoch wärmegeädämmtes Mehrkammersystem mit symmetrischem Aufbau, qualitätsgesichert im Werksverbund hergestellt
- Patentierte Eck- und Stoßverbindertechnik für hohe Bauteilfestigkeit
- Füllungsdicken bis 69 mm
- Optional mit Einbaurahmen für Integration in Pfosten-Riegel-Fassaden

Wärmeschutz:

- U_f -Werte: bis 1,5 W/(m²K)
- U_w -Werte: bis 1,0 W/(m²K) mit Dreifachglas

Dichtungskonzept:

- Spezielle Mehrkammer-Mitteldichtung mit Fahnen für hohe Dichtigkeitswerte und verbesserte Wärmedämmung

Beschläge:

- Schwinglager oder Wendelager, wahlweise
 - aufliegend oder
 - verdeckt
- Flügelgewichte:
 - Schwingfenster bis 150 kg
 - Wendefenster bis 120 kg
- Flügelformate B x H:
 - Schwingfenster bis 2.400 x 1.400 mm
 - Wendefenster bis 2.000 x 2.000 mm



**WICLINE 65 evo / WICLINE 75 evo
Einsatzflügel**

11



Die ideale Kombination: Pfosten-Riegel-Fassaden mit Aluminium-Einsatzflügeln der Serie WICLINE evo. Die flexiblen Systeme mit Spitzenwerten in den Leistungseigenschaften bieten individuelle Lösungen auf höchstem technischem und gestalterischem Niveau, angepasst mit einer großen Auswahl an zusätzlichen Funktionen.

21

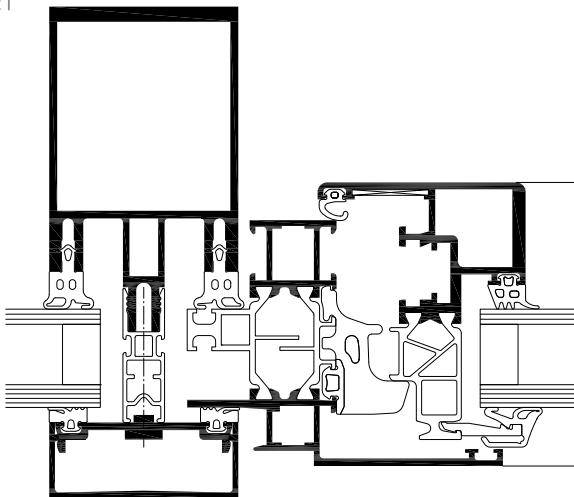

**Systemprüfungen / CE-Produktpass
nach DIN EN 14351-1:2006+A1:2010
sowie nach DIN EN 13830**

Siehe Klassifizierung der Fensterserien
und der Fassadenserien.

Technische Leistungen:

Profiltechnik:

- Hoch wärmegeädmmtes Mehrkammersystem mit symmetrischem Aufbau, qualitätsgesichert im Werksverbund hergestellt
- Patentierte Eck- und Stoßverbindertechnik für hohe Bauteilfestigkeit
- Füllungsdicken bis 69 mm

Wärmeschutz:

- Siehe Werte der jeweiligen Fenster- und Fassadenserien

Ausführungen, einwärts öffnend:

- Dreh- / Dreh-Kipp- / Kippfenster
- Verdeckter Flügel
- Schwingfenster
- Wendefenster
- Einbruchhemmende Ausführung

Beschläge:

- Verdeckt liegende Einhandbeschläge, wahlweise mit:
 - aufliegenden Bändern, farbig beschicht- oder eloxierbar
 - verdeckt liegenden Bändern mit integrierter Endlagendämpfung, Öffnungswinkel max. 105°
- Flügelgewichte:
 - Verdeckt liegende Bänder: bis 160 kg
 - Aufliegende Bänder: bis 200 kg
 - Auf Anfrage: bis 300 kg
- Flügelformate B x H: bis 1.700 x 2.500 mm
- Wahlweise mit Öffnungsbegrenzer in verschiedenen Varianten

Ausführungen, auswärts öffnend:

- Klappfenster
- Drehfenster
- Senk-Klappfenster

Beschläge:

- Aufliegende Klapp-, Drehbänder
- Verdeckt liegende Senk-Klapp-Scheren
- Flügelgewichte: bis 150 kg
- Flügelformate B x H: bis 2.000 x 2.000 mm

34
35

1 | Beispiel Darstellung flächenbündiger Flügel

2 | Beispiel Darstellung verdeckter Flügel

WICLINE 77IK
Industrie-Design
Dreh-/ Dreh-Kipp-/ Kippfenster
Stulpflügelfenster
Tilt-First-Fenster
Oberlicht

WICLINE 77IK Industrie-Design ist abgestimmt auf die Sanierung historischer Gebäude. Die Kontur der Profile übernimmt die Optik von Stahlprofilen und ermöglicht individuelle Gestaltungsmöglichkeiten wie Pfosten-Riegel-Strukturen, Sprossen oder verdeckte Flügel. Ob Neubau oder Sanierung, Einsatz als Lochfenster oder Fensterband, WICLINE 77IK bringt die unterschiedlichen technischen und gestalterischen Anforderungen in Einklang.

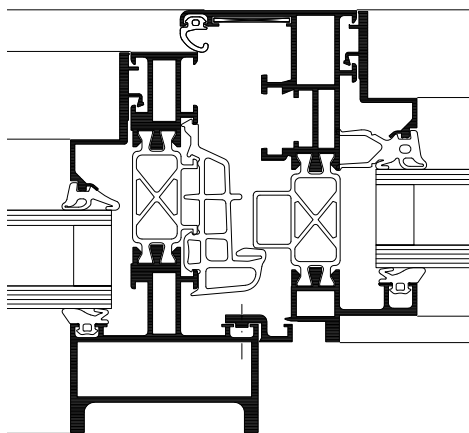

Systemprüfungen/CE-Produktpass
nach DIN EN 14351-1:2006+A1:2010

Luftdurchlässigkeit:	Klasse 4
Schlagregendichtheit:	9A
Widerstandsfähigkeit gegen Windlast:	Klasse C5/B5
Bedienkräfte:	Klasse 1
Dauerfunktion:	Klasse 2 (10.000 Zyklen)
Qualitätsmanagement:	Zertifiziert nach DIN EN ISO 9001:2008



Technische Leistungen:

Profiltechnik:

- Hoch wärmedämmtes Mehrkammersystem qualitätsgesichert im Werksverbund hergestellt
- Patentierte Eck- und Stoßverbindertechnik für hohe Bauteilfestigkeit
- Füllungsdicken bis 59 mm

Wärmeschutz:

- U_f -Werte: bis 1,4 W/(m²K)

Dichtungskonzept:

- Spezielle Mehrkammer-Mitteldichtung für hohe Dichtigkeitswerte und verbesserte Wärmedämmung

Beschläge:

- Verdeckt liegende Einhandbeschläge, wahlweise mit:
 - aufliegenden Bändern
 - verdeckt liegenden Bändern
- Flügelgewichte:
 - bis 100 kg
- Flügelformate B x H: bis 1.300 x 1.700 mm

Weitere Ausführungen in Industrie-Design:

- Verdeckter Flügel
- Flügel mit Überschlag
- Stulpfenster
- Fensterbänder mit geteilten Stützen
- Fensterselemente in Pfosten-Riegel-Optik
- Sprossenfenster mit scheidentrennenden Sprossen

WICLINE 65N
Ungedämmtes Fenster
Dreh-/ Dreh-Kipp-/ Kippfenster
Tilt-First-Fenster
Oberlicht



Innenbereiche und Gebäude, bei denen auf besondere Wärmeschutzmaßnahmen verzichtet werden kann, sind die Einsatzgebiete für WICLINE 65N. Ideal auch für den Einsatz als NRWG-Anwendungen.

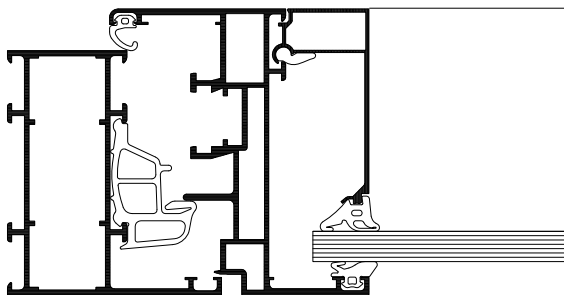

Systemprüfungen/ CE-Produktpass
nach DIN EN 14351-1:2006+A1:2010

Luftdurchlässigkeit:	Klasse 4
Schlagregendichtheit:	9A
Widerstandsfähigkeit gegen Windlast:	Klasse C5/B5
Bedienkräfte:	Klasse 1
Dauerfunktion:	Klasse 2 (10.000 Zyklen)
Einbruchhemmung:	WK1, WK2
Qualitätsmanagement:	Zertifiziert nach DIN EN ISO 9001:2008

Technische Leistungen:

Profiltechnik:

- Hochwertige Aluminiumprofile ungedämmt
- Patentierte Eck- und Stoßverbindertechnik für hohe Bauteilfestigkeit
- Füllungsdicken bis 58 mm

Beschläge:

- Verdeckt liegende Einhandbeschläge, wahlweise mit:
 - aufliegenden Bändern
 - verdeckt liegenden Bändern
- Flügelgewichte:
 - bis 100 kg
- Flügelformate B x H: bis 1.300 x 1.700 mm

Weitere Ausführungen ungedämmt:

- Fenstertüren ungedämmt
- NRWG-Anwendungen
- Einbruchhemmung

Kompatibel mit den Türserien
WICSTYLE 65N ungedämmt

WICLINE 125
Verbundfenster
Dreh-/ Dreh-Kipp-/ Kippfenster
Oberlicht



WICLINE 125 ist ein Verbundfenster-System für Objekte mit besonders hohem Anspruch an den Wärme- und Schallschutz. Die innere Fensterebene wird mit einem zusätzlichen Flügel kombiniert. Dadurch werden Schutzfunktion und Nutzerkomfort deutlich erhöht.

Ein Sonnenschutz kann zwischen den Außen- und Innenflügeln witterungsgeschützt, aber jederzeit zugänglich integriert werden.

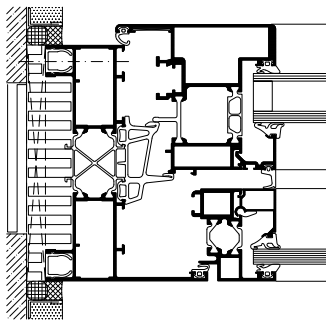

Systemprüfungen/ CE-Produktpass
nach DIN EN 14351-1:2006+A1:2010

Luftdurchlässigkeit:	Klasse 4
Schlagregendichtheit:	E750
Widerstandsfähigkeit gegen Windlast:	Klasse C5/B5
Schallschutz:	$R_w (C; C_{tr}) = 48 (-1; -4)$ dB
Bedienkräfte:	Klasse 1
Einbruchhemmung:	Bis WK3
Qualitätsmanagement:	Zertifiziert nach DIN EN ISO 9001:2008

Technische Leistungen:

Profiltechnik:

- Profildautiefen:
 - 125 mm: Blendrahmen- und Kämpferprofile
 - 136 mm: Verbundflügelprofile, Hauptflügel innen mit Überschlag
- Zwischen den Flügeln kann ein Sonnenschutzsystem integriert werden, geschützt vor Witterungseinflüssen und in der Anwendung unabhängig von Windgeschwindigkeiten

Wärmeschutz:

- U_w -Werte unter $0,9 \text{ W}/(\text{m}^2\text{K})$

Schallschutz:

- Schallschutz bis 48 dB

Einbruchhemmung:

- Widerstandsklassen von WK1 bis WK3 nach DIN V ENV 1627 realisierbar

Beschläge:

- Zulässiges Flügelgewicht (Verbundfenster gesamt) bis zu 160 kg

Varianten:

- Außenflügel wärmegeklämt
- Außenflügel verdeckt liegend
- Außenflügel mit Industrie-Design
- Außenflügel Ganzglas, geklebt

WICLINE 215 Hybrid-Fenster mit Doppelfassadentechnologie



Hoher Schallschutz auch bei geöffnetem Fenster?
Was auf den ersten Blick unvereinbar zu sein scheint, hat WICONA gelöst – mit WICLINE 215.
Ein zweischaliges Fenster mit den bauphysikalischen Werten einer Doppelfassade. Der neue Fenstertyp kombiniert ein nach innen öffnendes Flügel mit einem nach außen öffnenden Parallel-Abstellflügel. Beide können unabhängig voneinander geöffnet werden. Diese Konstruktion steigert das Wohlbefinden der Nutzer um ein Vielfaches: Individuelle Lüftung und automatische Steuerung zur Nachtauskühlung sorgen für ein angenehmes Raumklima. Noch mehr Komfort bietet ein im Glaszwischenraum der beiden Fensterflügel integrierter Sonnenschutz. Witterungsgeschützt und windunabhängig eingesetzt senkt dieser auch den Energieverbrauch.

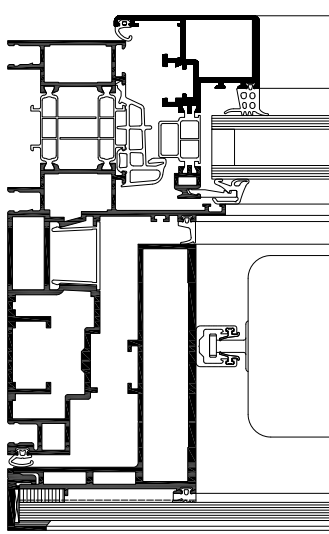

Systemprüfungen / CE-Produktpass nach DIN EN 14351-1:2006+A1:2010

WICLINE 215 ist eine objektspezifische Lösung, die individuell an die jeweilige Gebäudesituation angepasst werden kann. Die jeweiligen Anforderungen werden bei den Prüfungen berücksichtigt. Bitte fragen Sie Ihr zuständiges WICONA Verkaufsbüro nach einer persönlichen Beratung.

Technische Leistungen:

Systemtechnik:

- Hybridfenster im Doppelfassadenprinzip mit allen Vorteilen: innen manueller oder automatisierter Öffnungsflügel, außen Parallel-Abstellflügel
- Individuell zu öffnende Flügel, keine Nutzungseinschränkungen
- Integriert liegender Sonnenschutz, geschützt vor Wind, Schmutz und Witterungseinflüssen
- Geringe Bautiefe von 215 mm auch mit integriertem Sonnenschutz, Motorisierung und Steuerung
- Innenflügel auch bei geöffnetem Außenflügel gegen Einbruch und Witterungseinflüsse geschützt

Wärmeschutz:

- U_w -Wert bis 0,65 W/(m²K) erreichbar

Schallschutz:

- Erhöhter Schallschutz mit Standardgläsern bei geschlossenem Fenster; hoher Schallschutz bereits auch bei geöffnetem Außenflügel und Innenflügel
- Bei Einsatz von Schallschutzverglasung werden Schallschutzwerte bis 57 dB erreicht.

Beschläge:

- Innenflügel mit folgenden Optionen: Dreh, Dreh-Kipp, Kipp, Stulp, E-TecDrive, Oberlicht, Einbruchhemmung, Nachtauskühlung
- Außenflügel Parallel-Abstellflügel, mit Motorantrieb

Objektschutz und Nutzersicherheit – für Ihre Gebäudehüllen benötigen Sie einen Lösungsansatz, der ganzheitlich und mit kompatiblen Aluminiumkonstruktionen ausführbar ist. Diesen bieten die WICONA Serien im Bereich der Fenster, Fassaden und Türen in verschiedensten Ausprägungen, jeweils kombinierbar mit zusätzlichen Funktionen.

Die verschiedenen hohen Anforderungen im Bereich Einbruchhemmung werden bei allen WICLINE Fensterserien ohne optische Veränderungen, mit geringfügigen Zusatzmaßnahmen auf Basis der Grundkonstruktionen erfüllt.



Technische Leistungen:

Einbruchhemmung nach DIN EN 1627:

- Durch die Einführung der Norm für Einbruchhemmung EN 1627 in den europäischen Ländern wurden bestehende nationale Normen ersetzt. In Deutschland wurde beispielsweise im September 2011 die DIN 1627 durch die DIN EN 1627 abgelöst, die seit diesem Zeitpunkt gültig ist. Die Klassifizierung wurde dabei geändert auf die Klassen RC1N bis RC3. Diese sind jedoch nicht identisch mit den bisherigen Klassen WK1 bis WK3, da sich die Prüfanforderungen geändert haben.

Prüfungsergebnisse der WICONA Serien:

- Die neuen WICLINE 65 evo und WICLINE 75 evo Fensterserien in all ihren Varianten wurden nach der neuen Norm DIN EN 1627 geprüft und können dadurch nach den aktuellen Anforderungen ausgeschrieben, verbaut und gekennzeichnet werden.

Einbruchhemmung nach DIN EN 1627 bzw. DIN 1627 / Klassifizierungen:

WICLINE 65 evo / 75 evo Dreh/ Dreh-Kipp/ Kipp/ Tilt-First/ Stulp	RC1N, RC2N, RC2, RC3
WICLINE 65 evo / 75 evo Oberlicht	RC1N, RC2N, RC2, RC3
WICLINE 65 evo / 75 evo Verdeckter Flügel	RC1N, RC2N, RC2, RC3
WICLINE 65 evo / 75 evo Klassik-Design	RC1N, RC2N, RC2, RC3
WICLINE 125 Verbundfenster	WK1, WK2, WK3

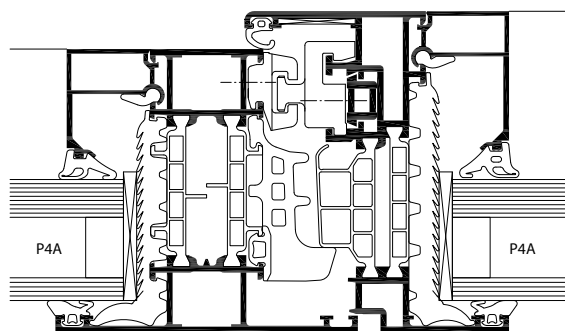

WICLINE 75 evo RC2

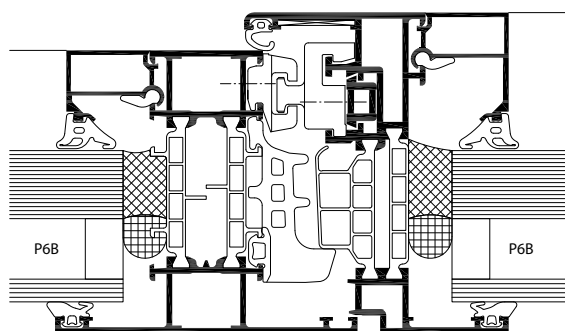

WICLINE 75 evo RC3

**Systemprüfungen / CE-Produktpass
nach DIN EN 14351-1:2006+A1:2010**

Siehe jeweilige Fensterserie

**WICLINE
Fenstersysteme
Durchschusshemmung**

Schutz und Sicherheit – für Ihre Gebäudehüllen benötigen Sie einen Lösungsansatz, der ganzheitlich und mit kompatiblen Aluminiumkonstruktionen ausführbar ist. Diesen bieten die WICONA Serien im Bereich der Fenster, Fassaden und Türen in verschiedensten Ausprägungen, jeweils kombinierbar mit zusätzlichen Funktionen. Die Anforderungen im Bereich Durchschusshemmung werden bei mehreren WICLINE Fensterprofil-Kombinationen einfach durch eine Erweiterung mit speziellen Aluminium-Vorsatzprofilen erreicht.

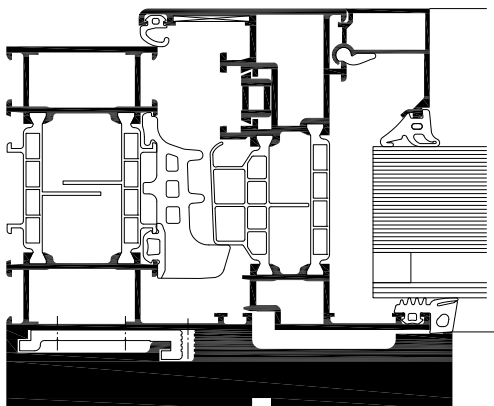

**Systemprüfungen/CE-Produktpass
nach DIN EN 14351-1:2006+A1:2010**

Siehe jeweilige Fensterserie



Technische Leistungen:

Durchschusshemmung nach DIN EN 1522:

- Die neuen WICLINE 65 evo und WICLINE 75 evo Fensterserien mit einfachen Systemerweiterungen wurden nach dieser Norm getestet und erfolgreich in den Klassen FB4 S und FB4 NS zertifiziert.
- Die Durchschusshemmung in Klasse FB4 S und FB4 NS ist realisierbar in verschiedenen Öffnungsarten, als Lochfenster oder als Fensterband, und kombinierbar mit Zusatzfunktionen wie Einbruchhemmung.

**Kombinierbare WICONA Produktserien in
Durchschusshemmung Klasse FB4:**

- Türen WICSTYLE 65 evo/WICSTYLE 75 evo
- Pfosten-Riegel-Fassaden WICTEC 50

**Durchschusshemmung nach
DIN EN 1522/Klassifizierungen:**

WICLINE 65 evo/75 evo Dreh/ Dreh-Kipp/ Kipp/ Tilt-First/Stulp	FB4 S/FB4 NS
WICLINE 65 evo/75 evo Oberlicht	FB4 S/FB4 NS

WICLINE 65 evo
Turn, turn-tilt, tilt windows
Double casement windows
Tilt first windows
Fanlights

State of the art technology and a comprehensive profile range make the aluminium window WICLINE 65 evo a perfect all-rounder with a versatile spectrum of applications.

By using a design depth of only 65 mm, this system meets high standards required for thermal and sound insulation. WICLINE 65 evo offers a very attractive price/performance ratio.

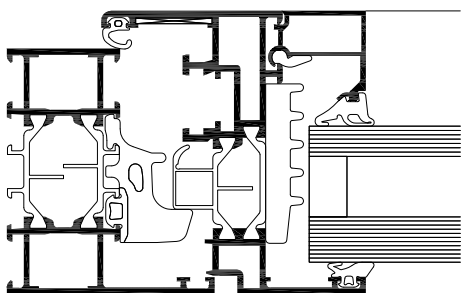

System test results / CE product pass in accordance with DIN EN 14351-1:2006+A1:2010

Air permeability:	Class 4
Watertightness:	E900
Resistance to wind load:	Class C5/B5
Acoustic performance:	$R_w (C_i; C_{tr}) = 47 (-1; -4)$ dB
Operating forces:	Class 1
Load bearing capacity of safety devices:	fulfilled
Mechanical strength:	Class 4
Repeated opening/closing:	Class 3 (20,000 cycles)
Corrosion resistance of the fittings:	Class 5
Burglar resistance:	RC1N, RC2N, RC2, RC3
Bullet resistance:	FB4 S, FB4 NS (depending on the glazing)
Quality assurance:	Certified according to DIN EN ISO 9001:2008



Technical performance:

Profile technology:

- High insulation multi-chamber system in symmetric design, quality assured thermal insulator connection
- Patented corner and butt joint connection technology for high rigidity of frames and sashes
- Infill thickness up to 59 mm

Thermal insulation:

- U_f values: until 1.4 W/(m²K)
- U_w values: until 0.93 W/(m²K) with triple glazing

Sealing concept:

- Centre gasket with three installation methods
 - Circumferential centre gasket, no joints in the corner areas
 - Formed corners, avoiding adhesive in the joints
 - Corner vulcanized frames

Fittings:

- Heavy duty system fittings with:
 - visible hinges, powder coating or anodization in all colours
 - concealed hinges with integrated end position damping, opening angle max. 105°
- Sash weight:
 - Visible fittings: up to 160 kg
 - Concealed fittings: up to 200 kg
 - On demand: up to 300 kg
- Sash sizes w x h: 1700 x 2500 mm, fanlight 2500 x 1700 mm
- Optionally with opening limiter

Additional designs:

- Concealed sash
- Classic Design
- Integration frame for stick façades
- Fanlight with hand lever, cranked rod or motor
- Pivot window, horizontal or vertical
- Parallel sliding window, with or without force operation
- Italian style window
- Top-hung window
- Window doors with barrier free threshold, single or double casement door, inward and outward opening
- Burglar resistance (see system tests)
- Bullet resistance (see system tests)

Compatible with the door series
WICSTYLE 65 evo and WICSTYLE 75 evo

WICLINE 75 evo
Turn, turn-tilt, tilt windows
Double casement windows
Tilt first windows
Fanlights
Mingerie-P Module-window

With 75 mm profile depth, WICLINE 75 evo features the highest thermal insulation properties and structural characteristics. With its superior technical performance this aluminium window is attuned to all architectural requirements of the future. In Switzerland WICLINE 75 evo has been the first metal window to be certified as Mingerie-P Module-window.

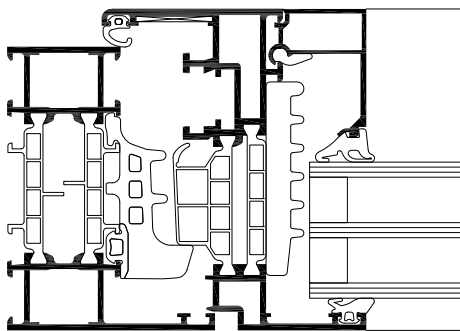

System test results / CE product pass in accordance with DIN EN 14351-1:2006+A1:2010

Air permeability:	Class 4
Watertightness:	E900
Resistance to wind load:	Class C5/B5
Acoustic performance:	$R_w (C; C_w) = 47 (-1; -4) \text{ dB}$
Operating forces:	Class 1
Load bearing capacity of safety devices:	fulfilled
Mechanical strength:	Class 4
Repeated opening/closing:	Class 3 (20,000 cycles)
Corrosion resistance of the fittings:	Class 5
Burglar resistance:	RC1N, RC2N, RC2, RC3
Bullet resistance:	FB4 S, FB4 NS (depending on the glazing)
Quality assurance:	Certified according to DIN EN ISO 9001:2008



Technical performance:

Profile technology:

- High insulation multi-chamber system in symmetric design, quality assured thermal insulator connection
- Patented corner and butt joint connection technology for high rigidity of frames and sashes
- Infill thickness up to 69 mm

Thermal insulation:

- U_f values: until $1.2 \text{ W}/(\text{m}^2\text{K})$
- U_w values: until $0.87 \text{ W}/(\text{m}^2\text{K})$ for sashes, until $0.72 \text{ W}/(\text{m}^2\text{K})$ for fixed glazing, with triple glazing
- Certified as Mingerie-P Module $U_w \leq 0,8 \text{ W}/(\text{m}^2\text{K})$

Sealing concept:

- Centre gasket with three installation methods
 - Circumferential centre gasket, no joints in the corner areas
 - Formed corners, avoiding adhesive in the joints
 - Corner vulcanized frames

Fittings:

- Heavy duty system fittings with:
 - visible hinges and fittings, powder coating or anodization in all colours
 - concealed hinges with integrated end position damping, opening angle max. 105°
- Sash weight:
 - Visible fittings: up to 160 kg
 - Concealed fittings: up to 200 kg
 - On demand: up to 300 kg
- Sash sizes $w \times h$: 1700 x 2500 mm, fanlight 2500 x 1700 mm
- Optionally with opening limiter

Additional designs:

- Concealed sash
- Classic Design
- Integration frame for stick façades
- Fanlight with hand lever, cranked rod or motor
- Pivot window, horizontal or vertical
- Parallel sliding window, with or without force operation
- Italian style window
- Top-hung window
- Window doors with barrier free threshold, single or double casement door, inward and outward opening
- Burglar resistance (see system tests)
- Bullet resistance (see system tests)

Compatible with the door series
WICSTYLE 65 evo and WICSTYLE 75 evo

WICLINE 65 evo / WICLINE 75 evo
Concealed sash

The option "Concealed Sash" in the aluminium window system WICLINE evo features a special glazing bead fixed directly in the thermal break zone. As a result the system achieves an extremely slim frame elevation, superior thermal insulation values and a groove-free profile design from outside. The improved ratio between frame and glazing surfaces leads to very good U_w -values, increased light transmissions and panoramic views.

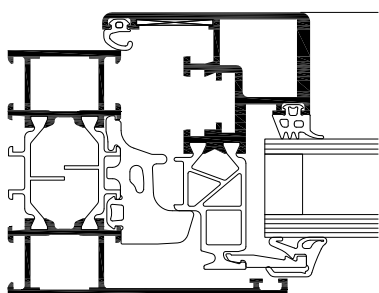
System test results / CE product pass in accordance with DIN EN 14351-1:2006+A1:2010

Air permeability:	Class 4
Watertightness:	E1200
Resistance to wind load:	Class C5 / B5
Operating forces:	Class 1
Load bearing capacity of safety devices:	fulfilled
Mechanical strength:	Class 4
Repeated opening / closing:	Class 2 (10,000 cycles)
Impact resistance:	Class 3
Burglar resistance:	RC1N, RC2N, RC2, RC3
Quality assurance:	Certified according to DIN EN ISO 9001:2008

Technical performance:
Profile technology:

- High insulation multi-chamber system in symmetric design, quality assured thermal insulator connection
- Patented corner and butt joint connection technology for high rigidity of frames and sashes
- Infill thickness up to 42 mm
- Optionally with integration frame for stick curtain walls

Thermal insulation:

- U_i values: until 1.5 W/(m²K)
- U_w values: until 0.94 W/(m²K) with triple glazing

Sealing concept:

- Voluminous centre gasket with three installation methods
 - Circumferential centre gasket, avoiding joints in the corner areas
 - Formed corners, avoiding adhesive in the joints
 - Corner vulcanized frames

Fittings:

- Heavy duty system fittings, with concealed hinges, integrated end position damping, opening angle max. 105°
- Sash weight:
 - Concealed fittings: up to 130 kg
- Sash sizes w x h: 1300 x 2250 mm
- Optionally with opening limiter in various executions

Additional designs in concealed sash design:

- Integration frame for stick façades
- Fanlight
- Burglar resistance (see system tests)

WICLINE 65 evo / WICLINE 75 evo
Classic design



Bevelled profile contours and overlapping sashes are characteristic for the aluminium window series WICLINE evo in Classic Design. This design underlines a style which is often requested for residential architecture. Ideal for new building and for energetic renovations alike.

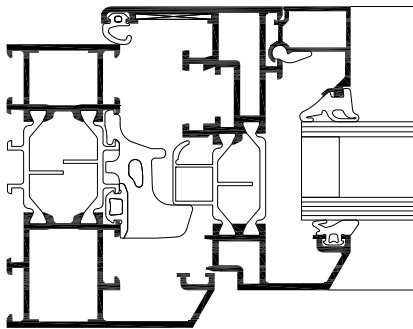

System test results / CE product pass in accordance with DIN EN 14351-1:2006+A1:2010

Air permeability:	Class 4
Watertightness:	E900
Resistance to wind load:	Class C5/B5
Acoustic performance:	$R_w(C;C_w) = 47 (-1;-4)$ dB
Operating forces:	Class 1
Load bearing capacity of safety devices:	fulfilled
Mechanical strength:	Class 4
Repeated opening/closing:	Class 3 (20,000 cycles)
Corrosion resistance of the fittings:	Class 5
Burglar resistance:	RC1N, RC2N, RC2, RC3
Quality assurance:	Certified according to DIN EN ISO 9001:2008

Technical performance:

Profile technology:

- High insulation multi-chamber system in symmetric design, quality assured thermal insulator connection, with 30° bevelled glazing rebates
- Patented corner and butt joint connection technology for high rigidity of frames and sashes
- Infill thickness up to 59 mm

Thermal insulation:

- U_f values: until 1.5 W/(m²K)
- U_w values: until 0.84 W/(m²K) with triple glazing

Sealing concept:

- Voluminous centre gasket with three installation methods
 - Circumferential centre gasket, avoiding joints in the corner areas
 - Formed corners, avoiding adhesive in the joints
 - Corner vulcanized frames

Fittings:

- Heavy duty system fittings with:
 - visible hinges, powder coating or anodization in all colours
 - concealed hinges with integrated end position damping, opening angle max. 105°
- Sash weight:
 - Visible fittings: up to 100 kg
 - Concealed fittings: up to 100 kg
- Sash sizes w x h: 1300 x 1700 mm
- Optionally with opening limiter in various executions

Additional options in Classic Design:

- Flush sash in Classic Design
- Overlapping sash and frame in Classic Design
- Fixed glazing
- Double casement window
- Crossbar profiles and glazing bars
- Integration frame for stick façades
- Fanlight
- Burglary resistance (see system tests)

WICLINE 65 evo / WICLINE 75 evo
Window door (French door),
barrier free threshold

With extended sash formats, single or double casement option and barrier free threshold this aluminium window door with inward or outward opening offers new freedom in architectural design. Superior technical performance and exemplary thermal insulation set new standards.

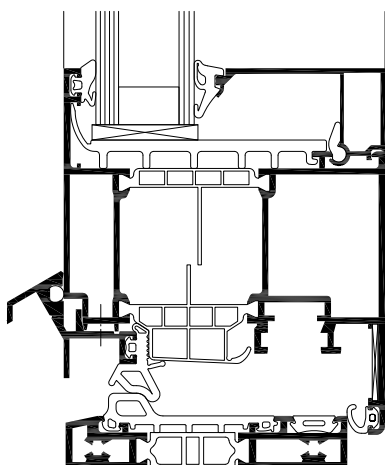

System test results / CE product pass in accordance
with DIN EN 14351-1:2006+A1:2010

	Inward opening:	Outward opening:
Air permeability:	Class 4	Class 4
Watertightness:	Until E900	7A
Resistance to wind load:	Until Class C5/B5	Class C3/B3
Operating forces:	Class 1	Class 1
Mechanical strength:	Class 4	Class 4
Repeated opening/closing:	Class 2 (10,000 cycles)	Class 2 (10,000 cycles)
Quality assurance:	Certified according to DIN EN ISO 9001:2008	



Technical performance:

Profile technology:

- High insulation multi-chamber system in symmetric design, quality assured thermal insulator connection
- Patented corner and butt joint connection technology for high rigidity of frames and sashes
- Infill thickness up to 69 mm
- Optional: barrier free threshold, thermally insulated

Thermal insulation:

- U_i values: until 1.3 W/(m²K)

Sealing concept:

- Voluminous centre gasket with three installation methods
 - Circumferential centre gasket, avoiding joints in the corner areas
 - Formed corners, avoiding adhesive in the joints
 - Corner vulcanized frames on 3 sides

Fittings:

- Alternatively inward or outward opening
- Single or double sash option
- Inward opening option with heavy duty system fittings, with visible hinges, powder coating or anodization in various colours.
- Sash weight:
 - up to 130 kg
- Sash sizes w x h:
 - inward opening: up to 1400 x 2500 mm,
 - outward opening: up to 1300 x 2250 mm
- Optionally with opening limiter in various executions

Compatible with the door series

WICSTYLE 65 evo and WICSTYLE 75 evo

WICLINE 65 evo / WICLINE 75 evo
Parallel sliding tilt window

In this space saving opening version the sash can be tilted or slid away to the side with ease. High operation comfort, versatile ventilation positioning without disturbing sash and the elevated technical performance values are characteristic for this opening type of the WICLINE evo aluminium window system.

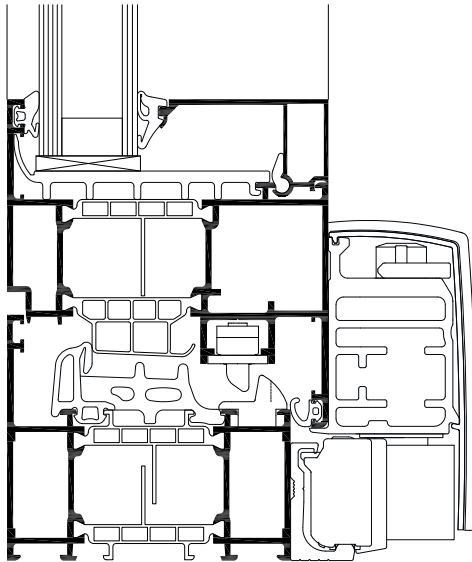

System test results / CE product pass in accordance with DIN EN 14351-1:2006+A1:2010

Air permeability:	Class 4
Watertightness:	E750
Resistance to wind load:	Class C5/B5
Operating forces:	Class 1
Mechanical strength:	Class 4
Repeated opening/closing:	Class 2 (10,000 cycles)
Quality assurance:	Certified according to DIN EN ISO 9001:2008



Technical performance:

Profile technology:

- High insulation multi-chamber system in symmetric design, quality assured thermal insulator connection
- Patented corner and butt joint connection technology for high rigidity of frames and sashes
- Infill thickness up to 69 mm

Thermal insulation:

- U_f values: until 1.2 W/(m²K)

Sealing concept:

- Voluminous centre gasket in corner vulcanized frames

Fittings:

- Parallel sliding tilt fittings, optionally
 - without force operation
 - with force operation (wfo)
- Sash weight:
 - up to 160 kg
 - up to 200 kg (wfo)
- Sash formats w x h:
 - up to 1685 x 2500 mm
 - up to 2000 x 2700 mm (wfo)

Compatible with the door series

WICSTYLE 65 evo and WICSTYLE 75 evo

WICLINE 65 evo / WICLINE 75 evo
Top-hung window / Side-hung window
Outward opening

The outward opening function frequently offers substantial benefits: efficient ventilation, no disturbing sash in the room, manual or motorized operation. With its very large sash formats and optimized functions WICLINE evo features in this option a more than interesting alternative for architecture.

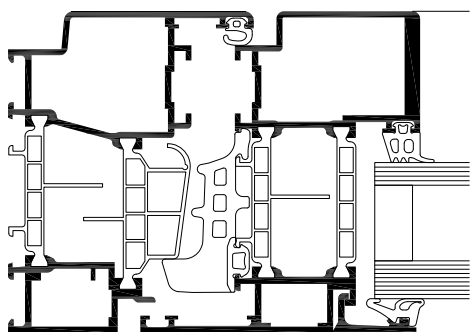

System test results / CE product pass in accordance with DIN EN 14351-1:2006+A1:2010

Air permeability:	Class 4
Watertightness:	E1200
Resistance to wind load:	Class C5/B5
Operating forces:	Class 1
Load bearing capacity of safety devices:	fulfilled
Mechanical strength:	Class 4
Repeated opening/closing:	Class 2 (10,000 cycles)
Impact resistance:	Class 3
Quality assurance:	Certified according to DIN EN ISO 9001:2008



Technical performance:

Profile technology:

- High insulation multi-chamber system in symmetric design, quality assured thermal insulator connection
- Patented corner and butt joint connection technology for high rigidity of frames and sashes
- Infill thickness up to 69 mm
- Optionally with integration frame for stick system curtain walls

Thermal insulation:

- U_f values: until 1.5 W/(m²K)
- U_w values: until 0.94 W/(m²K) with triple glazing

Sealing concept:

- Voluminous centre gasket with three installation methods
 - Circumferential centre gasket, avoiding joints in the corner areas
 - Formed corners, avoiding adhesive in the joints
 - Corner vulcanized frames

Fittings:

- Exterior visible turn fittings, optionally:
 - top-side application for top-hung opening
 - lateral application for side-hung opening
- Operation either manual or motorized
- Sash weight: up to 150 kg
- Sash formats w x h: up to 2000 x 2000 mm



WICLINE 65 evo / WICLINE 75 evo
Italian window
Outward opening

An elegant appearance combined with efficient ventilation are the characteristics of the aluminium system WICLINE evo in its Italian opening version. Concealed friction stays ensure an outward opening also for large size sashes, with a secure opening fixation in any position. Special frame profiles for punched windows or for curtain wall integration as well as a large selection of friction stay sizes guarantee maximum versatility of the system.

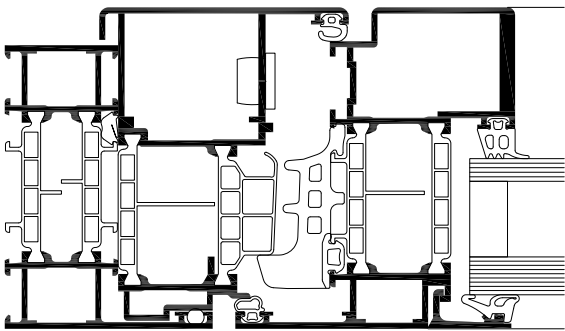

System test results / CE product pass in accordance with DIN EN 14351-1:2006+A1:2010

Air permeability:	Class 4
Watertightness:	E1200
Resistance to wind load:	Class C5/B5
Operating forces:	Class 1
Mechanical strength:	Class 4
Repeated opening/closing:	Class 2 (10,000 cycles)
Impact resistance:	Class 3
Quality assurance:	Certified according to DIN EN ISO 9001:2008



Technical performance:

Profile technology:

- High insulation multi-chamber system in symmetric design, quality assured thermal insulator connection
- Patented corner and butt joint connection technology for high rigidity of frames and sashes
- Infill thickness up to 69 mm
- Optionally with integration frame for stick system curtain walls

Thermal insulation:

- U_f values: until 1.5 W/(m²K)
- U_w values: until 1.0 W/(m²K) with triple glazing

Sealing concept:

- Voluminous centre gasket with formed corners

Fittings:

- Concealed integrated friction stay fittings, with vertical adjustment
- Operation either manual or motorized
- Sash weight: until 150 kg
- Sash formats w x h: until 2000 x 2200 mm

WICLINE 65 evo / WICLINE 75 evo
Pivot window, horizontal or vertical

A classic opening type becomes again a state-of-the-art product with WICONA technology: The horizontal and the vertical pivot windows based on the aluminium window system WICLINE evo offer improved thermal insulation, have achieved high classifications in CE-testing each, and with their option of visible or concealed fittings they are a real visual highlight for any punched or façade integrated window.

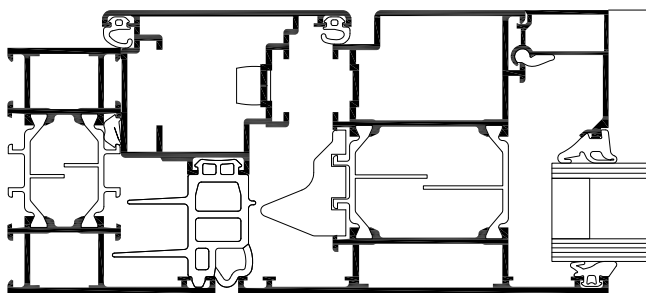
System test results / CE product pass in accordance with DIN EN 14351-1:2006+A1:2010

	horizontal	vertical
Air permeability:	Class 4	Class 4
Watertightness:	E750	4A
Resistance to wind load:	Class C5/B5	Class C5/B5
Operating forces:	Class 1	Class 1
Mechanical strength:	Class 4	Class 4
Repeated opening/closing:	Class 2 (10,000 cycles)	Class 2 (10,000 cycles)
Quality assurance:	Certified according to DIN EN ISO 9001:2008	

Technical performance:
Profile technology:

- High insulation multi-chamber system in symmetric design, quality assured thermal insulator connection
- Patented corner and butt joint connection technology for high rigidity of frames and sashes
- Infill thickness up to 69 mm
- Optionally with integration frame for stick system curtain walls

Thermal insulation:

- U_f values: until 1.5 W/(m²K)
- U_w values: until 1.0 W/(m²K) with triple glazing

Sealing concept:

- Special multi-chamber centre gasket with fins for superior tightness and improved thermal insulation

Fittings:

- Horizontal or vertical pivot fittings, optionally
 - with visible bearings or
 - with concealed bearings
- Sash weight:
 - horizontal: up to 150 kg
 - vertical: up to 120 kg
- Sash formats w x h:
 - horizontal: up to 2400 x 1400 mm
 - vertical: up to 2000 x 2000 mm



WICLINE 65 evo / WICLINE 75 evo
Integration sash

1 |



The ideal combination: WICTEC stick system curtain walls with integrated opening sashes from the WICLINE window series. The versatile systems with extended performances offer individual solutions on highest technical and design level, adaptable with a large selection of additional functions.

2 |

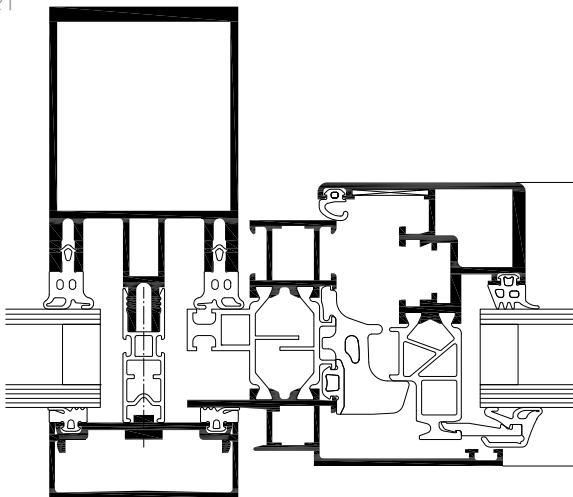

System test results / CE product pass in accordance with DIN EN 14351-1:2006+A1:2010 and DIN EN 13830:

See classification of the WICLINE window series and the WICTEC curtain wall series.

Technical performance:

Profile technology:

- High insulation multi-chamber system in symmetric design, quality assured thermal insulator connection
- Patented corner and butt joint connection technology for high rigidity of frames and sashes
- Infill thickness up to 69 mm

Thermal insulation:

- See values of the respective window and door series

Inward opening options:

- Turn / turn-tilt / tilt window
- Concealed sash
- Horizontal pivot window
- Vertical pivot window
- Burglar resistance

Fittings:

- Heavy duty system fittings with:
 - visible hinges, powder coating or anodization in all colours
 - concealed hinges with integrated end position damping, opening angle max. 105°
- Sash weight:
 - Visible turn/tilt fittings: up to 160 kg
 - Concealed turn/tilt fittings: up to 200 kg
 - Turn hinges (on demand): up to 300 kg
- Sash sizes w x h: 1700 x 2500 mm
- Optionally with opening limiter in various executions

Fittings, outward opening:

- Top-hung window
- Side-hung window
- Italian window

Fittings:

- Visible hinges top-hung or side-hung
- Concealed hinges Italian style window
- Sash weight: up to 150 kg
- Sash sizes w x h: up to 2000 x 2000 mm

1 | Example standard sash
 2 | Example concealed sash

WICLINE 77IK
Industrial design
Turn, turn-tilt, tilt windows
Double casement windows
Tilt-first windows
Fanlight

WICLINE 77IK Industrial Design is the ideal aluminium window for the renovation of historical buildings or to assign a technical look. The profile contour supports steel window design and individual adaptations like stick façade structures, crossbars in different alternatives or concealed sashes. Whether new build or renovation: WICLINE 77IK always makes it easy to fuse the various technical and design requirements.

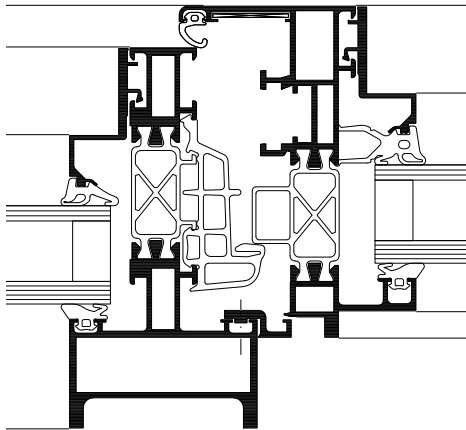

System test results / CE product pass in accordance with DIN EN 14351-1:2006+A1:2010

Air permeability:	Class 4
Watertightness:	9A
Resistance to wind load:	Class C5/B5
Operating forces:	Class 1
Repeated opening / closing:	Class 2 (10,000 cycles)
Quality assurance:	Certified according to DIN EN ISO 9001:2008

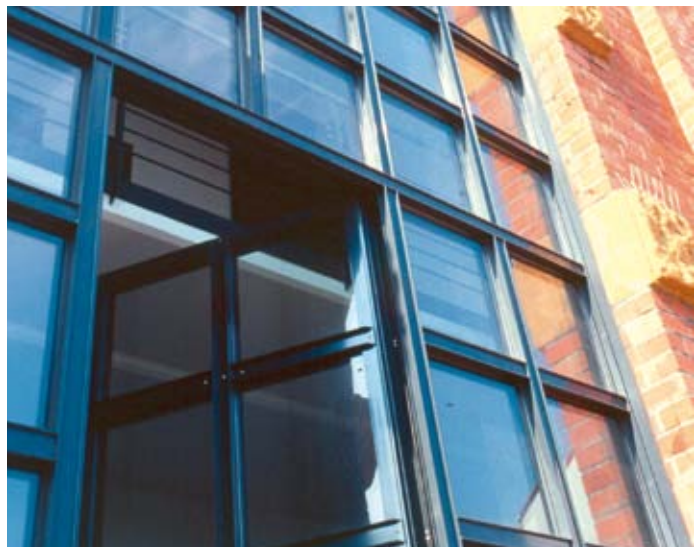

Technical performance:

Profile technology:

- High insulation multi-chamber system quality assured thermal insulator connection
- Patented corner and butt joint connection technology for high rigidity of frames and sashes
- Infill thickness up to 59 mm

Thermal insulation:

- U_f values: until 1.4 W/(m²K)
- U_w values: until 0.93 W/(m²K) with triple glazing

Sealing concept:

- Special multi-chamber centre gasket for superior tightness and improved thermal insulation

Fittings:

- Concealed single-handed operated fittings, alternatively with:
 - visible hinges
 - concealed hinges
- Sash weight:
 - up to 100 kg
- Sash sizes w x h: 1300 x 1700 mm

Additional options in Industrial Design:

- Concealed sash
- Overlapping sash profile
- Double casement window
- Ribbon windows with split mullion
- Window units with stick curtain wall structure
- Crossbar windows with glass partitioning crossbars

WICLINE 65N
Non-insulated
Turn, turn-tilt, tilt windows
Tilt first windows
Fanlight



The WICLINE 65N aluminium window is ideally suited for buildings in which specific heat protection measures are unnecessary. Ideal as well for the use as NSHEV (Natural smoke and heat extraction equipment).

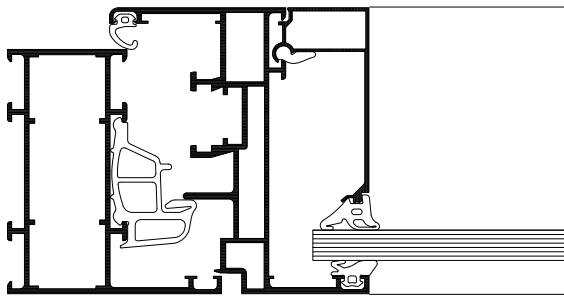

System test results / CE product pass in accordance with DIN EN 14351-1:2006+A1:2010

Air permeability:	Class 4
Watertightness:	9A
Resistance to wind load:	Class C5/B5
Operating forces:	Class 1
Repeated opening / closing:	Class 2 (10,000 cycles)
Burglar resistance:	WK1, WK2
Quality assurance:	Certified according to DIN EN ISO 9001:2008

Technical performance:

Profile technology:

- High quality aluminium profiles, without thermal break
- Patented corner and butt joint connection technology for high rigidity of frames and sashes
- Infill thickness up to 58 mm

Fittings:

- Concealed single-handed operated fittings, alternatively with:
 - visible hinges
 - concealed hinges
- Sash weight:
 - up to 100 kg
- Sash sizes w x h: 1300 x 1700 mm

Additional designs non-insulated:

- Window-doors/French doors
- NSHEV applications
- Burglar resistance

Compatible with the door series WICSTYLE 65N non-insulated

WICLINE 125
Coupled window
Turn, turn / tilt, tilt window
Fanlight

WICLINE 125 is a composite window system for buildings with particularly high thermal and sound insulation requirements. The interior sash is combined with an additional sash in front of it. This significantly increases the window's protective features, thermal performance and living comfort. Sun shading systems can be integrated in a weather protected way between the outer and inner sash.

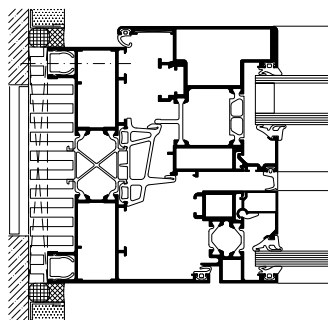

System test results / CE product pass in accordance with DIN EN 14351-1:2006+A1:2010

Air permeability:	Class 4
Watertightness:	E750
Resistance to wind load:	Class C5/B5
Acoustic performance:	$R_w (C_i; C_{tr}) = 48 (-1; -4) \text{ dB}$
Operating forces:	Class 1
Burglar resistance:	Until WK3
Quality assurance:	Certified according to DIN EN ISO 9001:2008



Technical performance:

Profile technology:

- Profile depths:
 - 125 mm: Frame and transom profiles
 - 136 mm: Combined sash profiles, main inner sash with overlap
- Between the two sashes a sunshade device can be integrated, protected from any weather influence and wind speeds

Thermal insulation:

- U_w values below $0.9 \text{ W}/(\text{m}^2\text{K})$

Sound insulation:

- Sound insulation up to 48 dB

Burglar resistance:

- Resistance classes from WK1 to WK3 in accordance with DIN V ENV 1627 can be achieved

Fittings:

- Permitted sash weight (total for combined windows) up to 160 kg

Optional designs:

- Outer sash – with thermal insulation
- Outer sash – concealed design
- Outer sash – industrial design
- Outer sash – all-glass window, glued

WICLINE 215
Hybrid window
with double skin technology



High sound insulation even when the window is open?
 WICONA has found a solution for an issue that at first appears irresolvable – the WICLINE 215. A double pane window with the same structural and physical values of a double skin façade. This new type of window combines an inward opening sash with a parallel projecting sash. Both can be operated independently. This construction multiplies the user comfort in many ways: individual ventilation, and automatic control for night cooling assure the best possible room climate. A sun protection device integrated between both sashes not only ensures even greater comfort, it also reduces energy consumption.

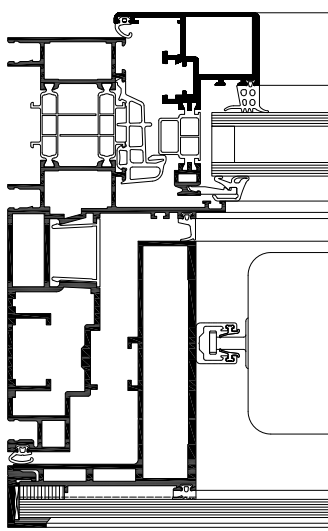

System test results / CE product pass in accordance with DIN EN 14351-1:2006+A1:2010

WICLINE 215 is a bespoke solution which is adapted to each individual project requirement. The respective needs are considered in the project specific testing. For further information and personal project support please contact your WICONA sales office.

Technical performance:

System technology:

- Hybrid window in double skin technology, with all its advantages: interior manual oder automatized sash, exterior parallel outward opening sash
- Two sashes that can be operated individually, no restrictions in use
- Integrated sun shading device, protected against high wind speeds, dirt and weathering
- Only 215 mm system depth, despite integrated solar protection, motor assistance and control system
- Inner sash protected from burglary or weathering even when outer window is open

Thermal Insulation:

- U_w values until $0.65 \text{ W}/(\text{m}^2\text{K})$ are feasible

Sound insulation:

- Superior sound insulation level with closed sashes, depending on the glazing. Increased sound insulation already with open exterior and interior sash.
- In combination with sound insulation glazing a protection level of 57 dB can be achieved.

Fittings:

- Interior sash with following options:
 - turn / turn-tilt / tilt / double casement / E-TecDrive / fanlight / burglar resistance / night cooling
- Exterior sash with motorized parallel outward opening operation

Personal security and building protection – for your building you need a solution approach which can be accomplished with aluminium systems in a wholistic and compatible way. This is achieved by the WICONA series for windows, curtain walls and doors. Each of them can be executed in burglar resistance, in combination with other additional functions. The various levels of resistance classes can be achieved with all WICLINE window series without visual alterations of the constructions, with only a minimum of additional measures on the basis of the standard design.

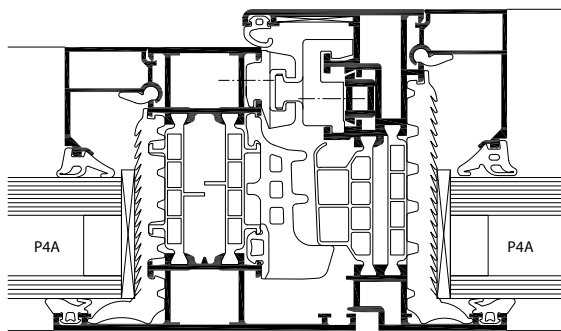

WICLINE 75 evo RC2

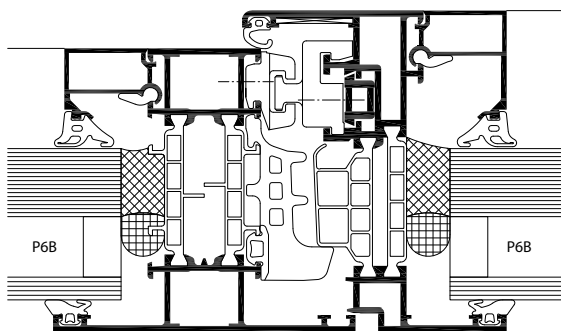

WICLINE 75 evo RC3

System test results / CE product pass in accordance with DIN EN 14351-1:2006+A1:2010

See classification of the respective WICLINE window series.



Technical performance:

Burglar resistance according to DIN EN 1627:

- The currently valid standard for burglar resistance, DIN EN 1627, has come into effect in European countries in 2011 and 2012. It replaced former national standards, like in Germany since September 2011 the standard DIN 1627. The classifications have been modified to classes RC1N to RC3, which are not identical with the former classes WK1 to WK3, as the test sequences have been changed.

Test results of the WICONA window series:

- The new WICLINE 65 evo and WICLINE 75 evo series with several variations have been tested according to the new standard DIN EN 1627. They can easily be specified and implemented without any additional measurement according to this new standard.

Burglar resistance according to DIN EN 1627 resp. DIN 1627 / classifications:

WICLINE 65 evo / 75 evo Turn / tilt-turn / tilt / tilt-first / double casement	RC1N, RC2N, RC2, RC3
WICLINE 65 evo / 75 evo Fanlight	RC1N, RC2N, RC2, RC3
WICLINE 65 evo / 75 evo Concealed sash	RC1N, RC2N, RC2, RC3
WICLINE 65 evo / 75 evo Classic design	RC1N, RC2N, RC2, RC3
WICLINE 125 Coupled window	WK1, WK2, WK3

Personal security and building protection – for your building you need a solution approach which can be accomplished with aluminium systems in a wholistic and compatible way. This is achieved by the WICONA series for windows, curtain walls and doors. Each of them can be executed in bullet resistance, in combination with other additional functions. The requirements for bullet resistance is achieved with various WICLINE window profile combinations, simply by addition of the standard construction with a special aluminium planking.

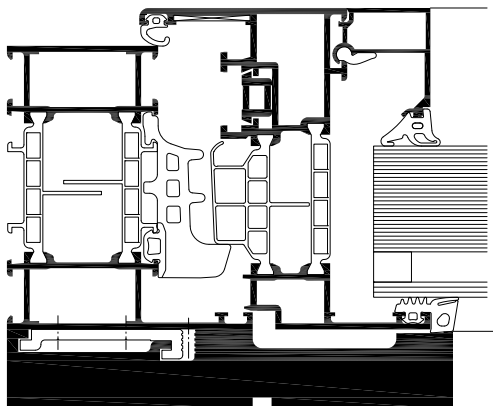

System test results / CE product pass in accordance with DIN EN 14351-1:2006+A1:2010

See classification of the respective WICLINE window series.

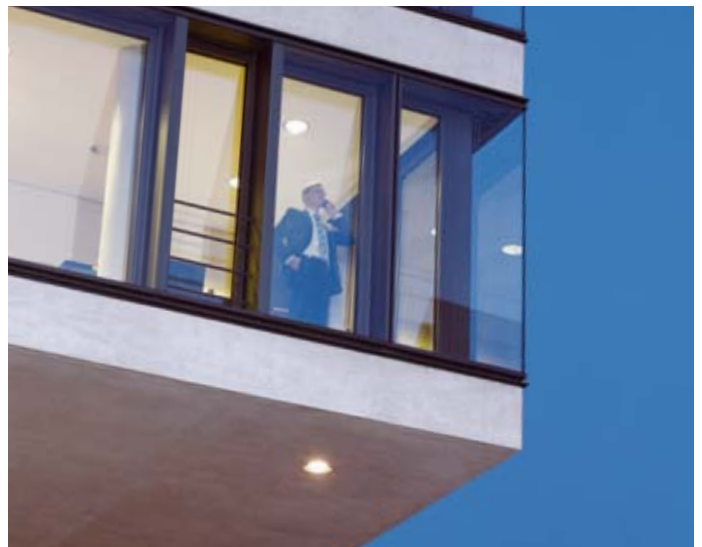

Technical performance:

Bullet resistance according to DIN EN 1522

- The bullet resistance requirements for windows are regulated Europe wide in the standard DIN EN 1522. The new window series WICLINE 65 evo and WICLINE 75 evo have been tested according to this standard in various profile combinations, and successfully been certified in class FB4 S and FB4 NS.
- Bullet resistance can be combined with burglar resistance in the classes RC1N, RC2N, RC2, RC3 according to DIN EN 1627.

Possible combinations with other WICONA product series in bullet resistance in class FB4:

- Doors WICSTYLE 65 evo / WICSTYLE 75 evo
- Stick curtain walls WICTEC 50

Bullet resistance according to DIN EN 1522 / classifications:

WICLINE 65 evo / 75 evo Turn / turn-tilt / tilt / tilt-first / double casement	FB4 S / FB4 NS
WICLINE 65 evo / 75 evo Fanlight	FB4 S / FB4 NS

» Wärmedämmung

Thermal insulation



WICLINE 65

Festverglasung
Fixed glazing

Wärmedämmung
Thermal insulation

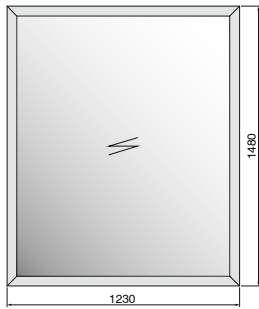

Ansichts- breite System width [mm]	Blendrahmen Frame		2-fach Glas Double glazing			3-fach Glas Triple glazing		
	Nr. No.	Breite Width [mm]	$U_f -$ [W/(m ² K)]	$U_w -$ [W/(m ² K)]		$U_f -$ [W/(m ² K)]	$U_w -$ [W/(m ² K)]	
				$U_g = 1,1$	$U_g = 0,9$		$U_g = 0,7$	$U_g = 0,5$
48	1916001	48	2,4	1,4	1,2	2,3	1,0	0,84
52	1916002	52	2,3	1,4	1,2	2,2	1,0	0,85
55	1916003	55	2,2	1,4	1,2	2,1	1,0	0,84
65	1916004	65	2,1	1,4	1,2	1,9	1,0	0,85
75	1916005	75	1,9	1,4	1,2	1,8	1,0	0,86

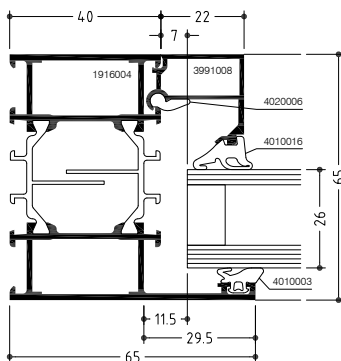

WICLINE 65

Drehkipp-Fenster
Turn/tilt window

Wärmedämmung
Thermal insulation

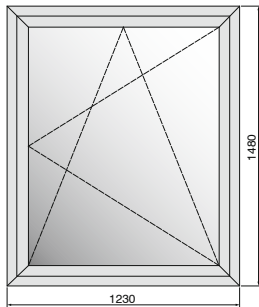

Ansichts- breite System width [mm]	Blendrahmen Frame		Flügel Sash		2-fach Glas Double glazing			3-fach Glas Triple glazing		
	Nr. No.	Breite Width [mm]	Nr. No.	Breite Width [mm]	$U_i -$ [W/(m ² K)]	$U_w -$ [W/(m ² K)] $U_g = 1,1$ $U_g = 0,9$		$U_i -$ [W/(m ² K)]	$U_w -$ [W/(m ² K)] $U_g = 0,7$ $U_g = 0,5$	
88	1916001	48	1916101	34	2,3	1,5	1,3	2,2	1,2	1,0
95	1916001	48	1916102	41	2,2	1,5	1,3	2,1	1,2	1,0
105	1916001	48	1916103	51	2,1	1,5	1,3	2,0	1,2	1,0
115	1916001	48	1916104	61	2,0	1,5	1,3	1,9	1,2	1,1
92	1916002	52	1916101	34	2,3	1,5	1,4	2,1	1,2	1,0
99	1916002	52	1916102	41	2,2	1,5	1,4	2,0	1,2	1,1
109	1916002	52	1916103	51	2,1	1,5	1,4	1,9	1,2	1,1
119	1916002	52	1916104	61	2,0	1,5	1,4	1,8	1,2	1,1
95	1916003	55	1916101	34	2,2	1,5	1,3	2,1	1,2	1,0
102	1916003	55	1916102	41	2,1	1,5	1,3	2,0	1,2	1,0
112	1916003	55	1916103	51	2,0	1,5	1,3	1,9	1,2	1,0
122	1916003	55	1916104	61	2,0	1,5	1,4	1,8	1,2	1,1
105	1916004	65	1916101	34	2,1	1,5	1,3	2,0	1,2	1,0
112	1916004	65	1916102	41	2,0	1,5	1,3	1,9	1,2	1,0
122	1916004	65	1916103	51	2,0	1,5	1,4	1,8	1,2	1,1
132	1916004	65	1916104	61	1,9	1,5	1,3	1,7	1,2	1,1
115	1916005	75	1916101	34	2,0	1,5	1,3	1,9	1,2	1,1
122	1916005	75	1916102	41	2,0	1,5	1,4	1,8	1,2	1,1
132	1916005	75	1916103	51	1,9	1,5	1,3	1,7	1,2	1,1
142	1916005	75	1916104	61	1,8	1,5	1,3	1,7	1,2	1,1

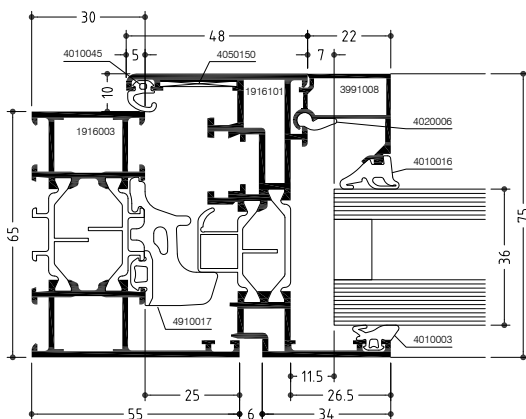

WICLINE 65

Drehkipp - Fenster mit Festverglasung
Turn/tilt window with fixed glazing

Wärmedämmung
Thermal insulation

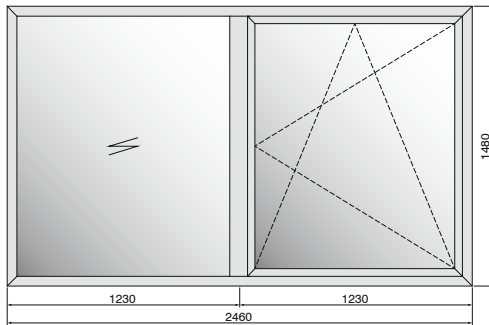

Ansichts- breite System width [mm]	Kämpfer Transom		Flügel Sash		Rahmen Nr. Frame No.	2-fach Glas Double glazing					3-fach Glas Triple glazing				
	Nr. No.	Breite Width [mm]	Nr. No.	Breite Width [mm]		U_t Kämpfer U_t transom	U_t Festfeld U_t fixed	U_t Flügel U_t sash	U_w - [W/(m²K)]		U_t Kämpfer U_t transom	U_t Festfeld U_t fixed	U_t Flügel U_t sash	U_w - [W/(m²K)]	
									$U_g = 1,1$	$U_g = 0,9$				$U_g = 0,7$	$U_g = 0,5$
120	1916203	80	1916101	34	1916001	2,3	2,4	2,3	1,5	1,3	2,2	2,3	2,2	1,1	0,91
127	1916203	80	1916102	41	1916001	2,3	2,4	2,2	1,5	1,3	2,1	2,3	2,1	1,1	0,91
137	1916203	80	1916103	51	1916001	2,2	2,4	2,1	1,5	1,3	2,1	2,3	2,0	1,1	0,92
147	1916203	80	1916104	61	1916001	2,2	2,4	2,0	1,5	1,3	2,0	2,3	1,9	1,1	0,92
130	1916204	90	1916101	34	1916002	2,3	2,3	2,3	1,5	1,3	2,1	2,2	2,1	1,1	0,91
137	1916204	90	1916102	41	1916002	2,2	2,3	2,2	1,5	1,3	2,1	2,2	2,0	1,1	0,92
147	1916204	90	1916103	51	1916002	2,2	2,3	2,1	1,5	1,3	2,0	2,2	1,9	1,1	0,92
157	1916204	90	1916104	61	1916002	2,1	2,3	2,0	1,5	1,3	2,0	2,2	1,8	1,1	0,93
140	1916205	100	1916101	34	1916003	2,2	2,2	2,2	1,5	1,3	2,1	2,1	2,1	1,1	0,92
147	1916205	100	1916102	41	1916003	2,2	2,2	2,1	1,5	1,3	2,0	2,1	2,0	1,1	0,92
157	1916205	100	1916103	51	1916003	2,1	2,2	2,0	1,5	1,3	2,0	2,1	1,9	1,1	0,93
167	1916205	100	1916104	61	1916003	2,1	2,2	2,0	1,5	1,3	1,9	2,1	1,8	1,1	0,93
150	1916206	110	1916101	34	1916004	2,1	2,1	2,1	1,5	1,3	2,0	1,9	2,0	1,1	0,92
157	1916206	110	1916102	41	1916004	2,1	2,1	2,0	1,5	1,3	2,0	1,9	1,9	1,1	0,93
167	1916206	110	1916103	51	1916004	2,1	2,1	2,0	1,5	1,3	1,9	1,9	1,8	1,1	0,93
177	1916206	110	1916104	61	1916004	2,0	2,1	1,9	1,5	1,3	1,9	1,9	1,7	1,1	0,94
160	1916207	120	1916101	34	1916005	2,1	1,9	2,0	1,5	1,3	1,9	1,8	1,9	1,1	0,93
167	1916207	120	1916102	41	1916005	2,1	1,9	2,0	1,5	1,3	1,9	1,8	1,8	1,1	0,93
177	1916207	120	1916103	51	1916005	2,0	1,9	1,9	1,5	1,3	1,9	1,8	1,7	1,1	0,94
187	1916207	120	1916104	61	1916005	2,0	1,9	1,8	1,4	1,3	1,8	1,8	1,7	1,1	0,94

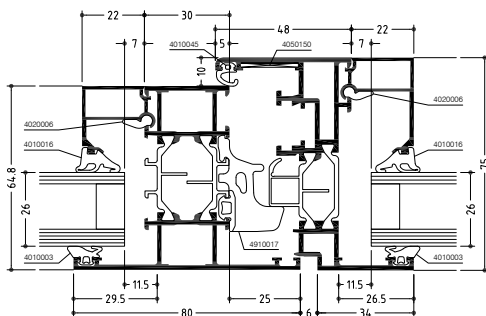

WICLINE 65

Spezial-Dämmprofil - Festverglasung
Special insulation profile - Fixed glazing

Wärmedämmung
Thermal insulation

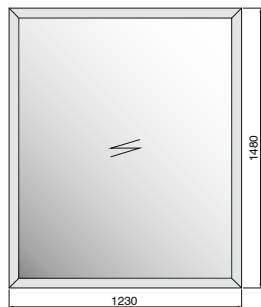

Ansichts- breite System width [mm]	Blendrahmen <i>Frame</i>		2-fach Glas <i>Double glazing</i>			3-fach Glas <i>Triple glazing</i>		
	Nr. <i>No.</i>	Breite Width [mm]	$U_f -$ [W/(m ² K)]	$U_w -$ [W/(m ² K)] $U_g = 1,1$ $U_g = 0,9$		$U_f -$ [W/(m ² K)]	$U_w -$ [W/(m ² K)] $U_g = 0,7$ $U_g = 0,5$	
48	1916001	48	1,7	1,3	1,1	1,6	0,93	0,75
52	1916002	52	1,6	1,3	1,1	1,5	0,93	0,74
55	1916003	55	1,6	1,3	1,1	1,5	0,94	0,75
65	1916004	65	1,5	1,3	1,1	1,4	0,94	0,76
75	1916005	75	1,4	1,3	1,1	1,3	0,93	0,76

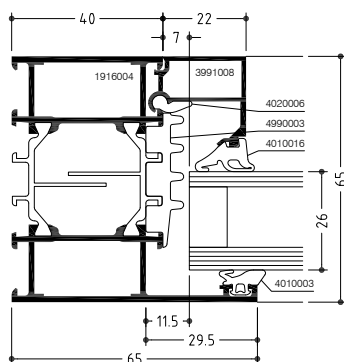

WICLINE 65

Spezial-Dämmprofil - Drehkipp-Fenster
Special insulation profile - Turn/tilt window

Wärmedämmung
Thermal insulation

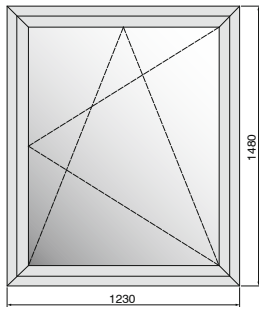

Ansichts- breite System width [mm]	Blendrahmen <i>Frame</i>		Flügel <i>Sash</i>		2-fach Glas <i>Double glazing</i>			3-fach Glas <i>Triple glazing</i>		
	Nr. No.	Breite Width [mm]	Nr. No.	Breite Width [mm]	U_i - [W/(m ² K)]	U_w - [W/(m ² K)] $U_g = 1,1$ $U_g = 0,9$		U_i - [W/(m ² K)]	U_w - [W/(m ² K)] $U_g = 0,7$ $U_g = 0,5$	
88	1916001	48	1916101	34	1,9	1,4	1,2	1,8	1,1	0,93
95	1916001	48	1916102	41	1,8	1,4	1,2	1,7	1,1	0,93
105	1916001	48	1916103	51	1,8	1,4	1,3	1,7	1,1	0,96
115	1916001	48	1916104	61	1,7	1,4	1,2	1,6	1,1	0,96
92	1916002	52	1916101	34	1,9	1,4	1,3	1,8	1,1	0,94
99	1916002	52	1916102	41	1,8	1,4	1,2	1,7	1,1	0,94
109	1916002	52	1916103	51	1,7	1,4	1,2	1,6	1,1	0,94
119	1916002	52	1916104	61	1,7	1,4	1,3	1,6	1,1	0,97
95	1916003	55	1916101	34	1,8	1,4	1,2	1,7	1,1	0,93
102	1916003	55	1916102	41	1,8	1,4	1,3	1,7	1,1	0,95
112	1916003	55	1916103	51	1,7	1,4	1,2	1,6	1,1	0,95
122	1916003	55	1916104	61	1,7	1,4	1,3	1,6	1,1	0,98
105	1916004	65	1916101	34	1,8	1,4	1,3	1,7	1,1	0,96
112	1916004	65	1916102	41	1,7	1,4	1,2	1,6	1,1	0,95
122	1916004	65	1916103	51	1,7	1,4	1,3	1,6	1,1	0,98
132	1916004	65	1916104	61	1,6	1,4	1,2	1,5	1,1	0,97
115	1916005	75	1916101	34	1,7	1,4	1,2	1,6	1,1	0,96
122	1916005	75	1916102	41	1,7	1,4	1,3	1,6	1,1	0,98
132	1916005	75	1916103	51	1,6	1,4	1,2	1,5	1,1	0,97
142	1916005	75	1916104	61	1,6	1,4	1,3	1,5	1,1	1,0

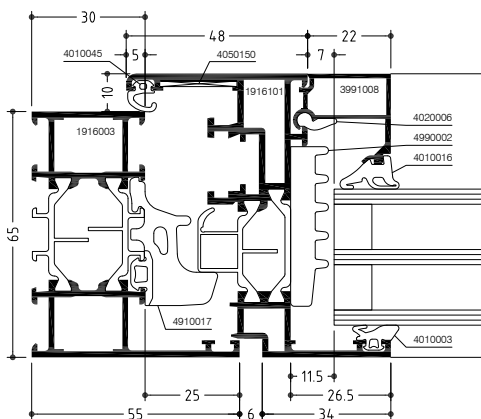

WICLINE 65

Spezial-Dämmprofil - Drehkipp - Fenster mit Festverglasung
 Special insulation profile - Turn/tilt window with fixed glazing

Wärmedämmung
 Thermal insulation

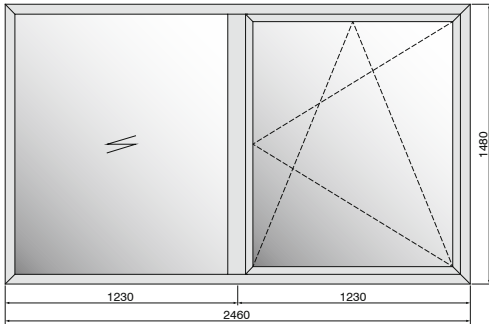

Ansichts- breite System width [mm]	Kämpfer Transom		Flügel Sash		Rahmen Nr. Frame No.	2-fach Glas Double glazing					3-fach Glas Triple glazing				
	Nr. No.	Breite Width [mm]	Nr. No.	Breite Width [mm]		U_t Kämpfer U_t transom	U_t Festfeld U_t fixed	U_t Flügel U_t sash	$U_w - [W/(m^2K)]$		U_t Kämpfer U_t transom	U_t Festfeld U_t fixed	U_t Flügel U_t sash	$U_w - [W/(m^2K)]$	
									$U_g = 1,1$	$U_g = 0,9$				$U_g = 0,7$	$U_g = 0,5$
120	1916203	80	1916101	34	1916001	2,1	1,7	1,9	1,4	1,2	2,0	1,6	1,8	1,0	0,83
127	1916203	80	1916102	41	1916001	2,1	1,7	1,8	1,4	1,2	2,0	1,6	1,7	1,0	0,84
137	1916203	80	1916103	51	1916001	2,0	1,7	1,8	1,4	1,2	1,9	1,6	1,7	1,0	0,84
147	1916203	80	1916104	61	1916001	2,0	1,7	1,7	1,4	1,2	1,9	1,6	1,6	1,0	0,85
130	1916204	90	1916101	34	1916002	2,1	1,6	1,9	1,4	1,2	2,0	1,5	1,8	1,0	0,84
137	1916204	90	1916102	41	1916002	2,0	1,6	1,8	1,4	1,2	1,9	1,5	1,7	1,0	0,84
147	1916204	90	1916103	51	1916002	2,0	1,6	1,7	1,4	1,2	1,9	1,5	1,6	1,0	0,85
157	1916204	90	1916104	61	1916002	2,0	1,6	1,7	1,4	1,2	1,9	1,5	1,6	1,0	0,85
140	1916205	100	1916101	34	1916003	2,0	1,6	1,8	1,4	1,2	1,9	1,5	1,7	1,0	0,84
147	1916205	100	1916102	41	1916003	2,0	1,6	1,8	1,4	1,2	1,9	1,5	1,7	1,0	0,85
157	1916205	100	1916103	51	1916003	2,0	1,6	1,7	1,4	1,2	1,9	1,5	1,6	1,0	0,86
167	1916205	100	1916104	61	1916003	1,9	1,6	1,7	1,4	1,2	1,8	1,5	1,6	1,0	0,86
150	1916206	110	1916101	34	1916004	2,0	1,5	1,8	1,4	1,2	1,9	1,4	1,7	1,0	0,85
157	1916206	110	1916102	41	1916004	2,0	1,5	1,7	1,4	1,2	1,9	1,4	1,6	1,0	0,86
167	1916206	110	1916103	51	1916004	1,9	1,5	1,7	1,4	1,2	1,8	1,4	1,6	1,0	0,86
177	1916206	110	1916104	61	1916004	1,9	1,5	1,6	1,4	1,2	1,8	1,4	1,5	1,0	0,87
160	1916207	120	1916101	34	1916005	2,0	1,4	1,7	1,4	1,2	1,9	1,3	1,6	1,0	0,86
167	1916207	120	1916102	41	1916005	1,9	1,4	1,7	1,4	1,2	1,8	1,3	1,6	1,0	0,86
177	1916207	120	1916103	51	1916005	1,9	1,4	1,6	1,4	1,2	1,8	1,3	1,5	1,0	0,87
187	1916207	120	1916104	61	1916005	1,9	1,4	1,6	1,4	1,2	1,8	1,3	1,5	1,0	0,87

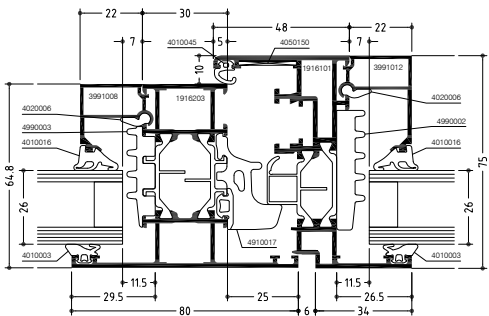

WICLINE 65

Verdeckter Flügel - Festverglasung
Concealed sash profile - Fixed glazing

Wärmedämmung
Thermal insulation

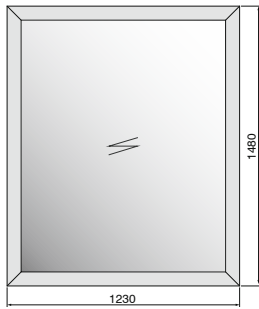

Ansichts- breite System width [mm]	Blendrahmen Frame		U_i - [W/(m ² K)]	2-fach Glas Double glazing		3-fach Glas Triple glazing	
	Nr. No.	Breite Width [mm]		U_w - [W/(m ² K)]		U_w - [W/(m ² K)]	
				$U_g = 1,1$	$U_g = 0,9$	$U_g = 0,7$	$U_g = 0,5$
74	1916081	74	1,4	1,3	1,1	0,95	0,78
84	1916082	84	1,4	1,3	1,1	0,97	0,80
84	1916086	84	1,4	1,3	1,1	0,97	0,80

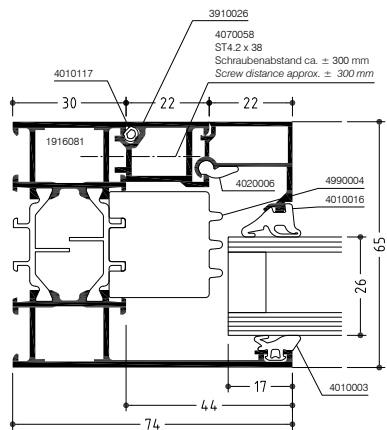

WICLINE 65

Verdeckter Flügel - Drehkipp-Fenster
Concealed sash profile - Turn/tilt window

Wärmedämmung
Thermal insulation

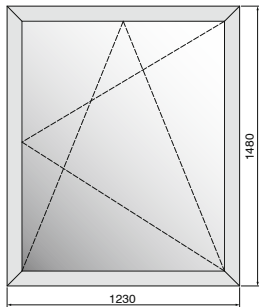

Ansichts- breite System width [mm]	Blendrahmen <i>Frame</i>		Flügel <i>Sash</i>		U_i – [W/(m ² K)]	2-fach Glas <i>Double glazing</i>		3-fach Glas <i>Triple glazing</i>	
	Nr. <i>No.</i>	Breite Width [mm]	Nr. <i>No.</i>	Breite Width [mm]		U_w – [W/(m ² K)]		U_w – [W/(m ² K)]	
						$U_g = 1,1$	$U_g = 0,9$	$U_g = 0,7$	$U_g = 0,5$
80	1916081	74	1916110	6	1,9	1,4	1,2	1,1	0,90
80	1916081	74	1916111	6	1,9	1,4	1,2	1,1	0,90
90	1916081	74	1916112	16	1,9	1,4	1,3	1,1	0,94
90	1916081	74	1916113	16	1,9	1,4	1,3	1,1	0,94
90	1916082	84	1916110	6	1,9	1,4	1,3	1,1	0,94
90	1916082	84	1916111	6	1,9	1,4	1,3	1,1	0,94
100	1916082	84	1916112	16	1,9	1,4	1,3	1,1	0,97
100	1916082	84	1916113	16	1,9	1,4	1,3	1,1	0,97
90	1916086	84	1916110	6	1,9	1,4	1,3	1,1	0,94
90	1916086	84	1916111	6	1,9	1,4	1,3	1,1	0,94
100	1916086	84	1916112	16	1,9	1,4	1,3	1,1	0,97
100	1916086	84	1916113	16	1,9	1,4	1,3	1,1	0,97

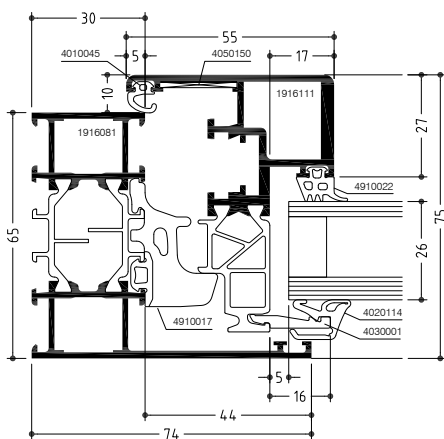

WICLINE 65

Klassik-Design - Festverglasung
 Classic design - Fixed glazing

Wärmedämmung
 Thermal insulation

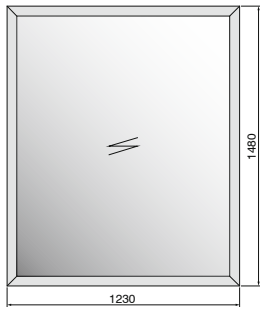

Ansichts- breite System width [mm]	Blendrahmen Frame		2-fach Glas Double glazing			3-fach Glas Triple glazing		
	Nr. No.	Breite Width [mm]	U_f - [W/(m²K)]	U_w - [W/(m²K)]		U_f - [W/(m²K)]	U_w - [W/(m²K)]	
				$U_g = 1,1$	$U_g = 0,9$		$U_g = 0,7$	$U_g = 0,5$
55	1916009	55	2,5	1,5	1,3	2,4	1,1	0,89

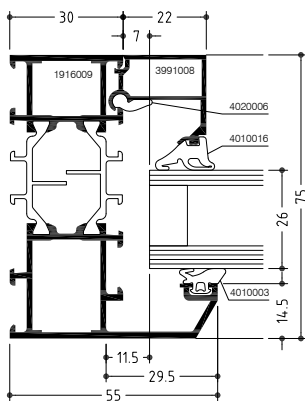

WICLINE 65

Klassik-Design - Drehkipp-Fenster
 Classic design - Turn/tilt window

Wärmedämmung
 Thermal insulation

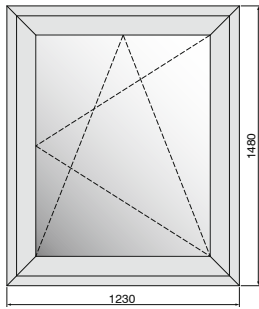

Ansichts- breite System width [mm]	Blendrahmen Frame		Flügel Sash		2-fach Glas Double glazing			3-fach Glas Triple glazing		
	Nr. No.	Breite Width [mm]	Nr. No.	Breite Width [mm]	U_i – [W/(m ² K)]	U_w – [W/(m ² K)] $U_g = 1,1$ $U_g = 0,9$		U_i – [W/(m ² K)]	U_w – [W/(m ² K)] $U_g = 0,7$ $U_g = 0,5$	
91	1916009	55	1916105	30	2,3	1,5	1,4	2,2	1,2	1,0

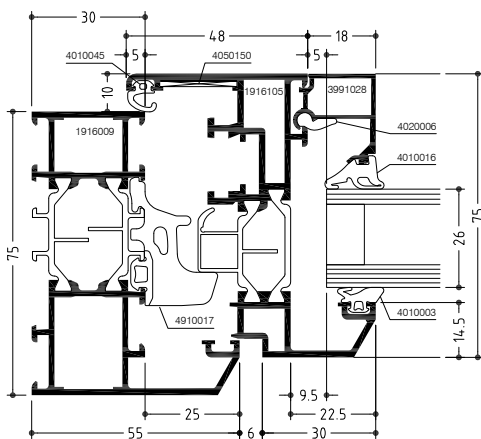

WICLINE 65

Klassik-Design - Drehkipp - Fenster mit Festverglasung
 Classic design - Turn/tilt window with fixed glazing

Wärmedämmung
 Thermal insulation

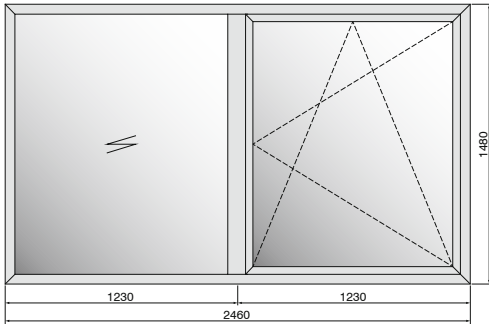

Anschafts- breite System width [mm]	Kämpfer Transom		Flügel Sash		Rahmen Nr. Frame No.	2-fach Glas Double glazing					3-fach Glas Triple glazing				
	Nr. No.	Breite Width [mm]	Nr. No.	Breite Width [mm]		U_i Kämpfer U_i transom	U_i Festfeld U_i fixed	U_i Flügel U_i sash	U_w - [W/(m²K)]		U_i Kämpfer U_i transom	U_i Festfeld U_i fixed	U_i Flügel U_i sash	U_w - [W/(m²K)]	
									U_g =	U_g =				U_g =	U_g =
116	1916334	80	1916105	30	1916009	2,3	2,5	2,3	1,5	1,3	2,2	1,7	1,9	1,0	0,87

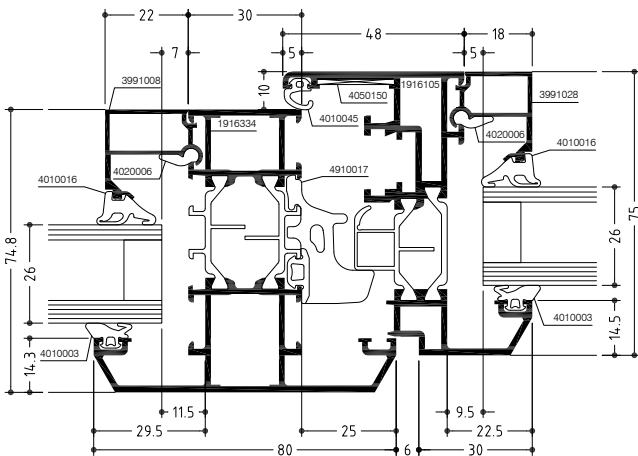

WICLINE 65

Klassik-Design mit Spezial-Dämmprofil - Festverglasung
 Classic design with special insulation profile - Fixed glazing

Wärmedämmung
 Thermal insulation

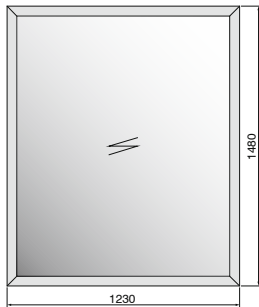

Ansichts- breite System width [mm]	Blendrahmen Frame		2-fach Glas Double glazing			3-fach Glas Triple glazing		
	Nr. No.	Breite Width [mm]	U_f - [W/(m²K)]	U_w - [W/(m²K)] $U_g = 1,1$ $U_g = 0,9$		U_f - [W/(m²K)]	U_w - [W/(m²K)] $U_g = 0,7$ $U_g = 0,5$	
55	1916009	55	1,8	1,3	1,1	1,7	0,97	0,78

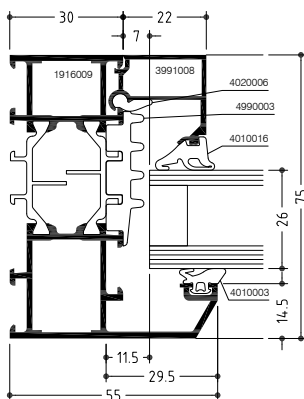

WICLINE 65

Klassik-Design mit Spezialdämmprofil - Drehkipp-Fenster
 Classic design with special insulation profile - Turn/tilt window

Wärmedämmung
 Thermal insulation

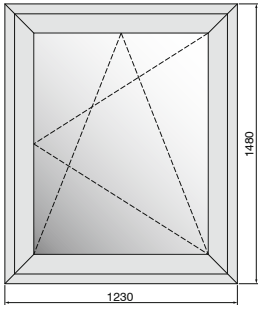

Ansichts- breite System width [mm]	Blendrahmen Frame		Flügel Sash		2-fach Glas Double glazing			3-fach Glas Triple glazing		
	Nr. No.	Breite Width [mm]	Nr. No.	Breite Width [mm]	$U_i -$ [W/(m²K)]	$U_w -$ [W/(m²K)]		$U_i -$ [W/(m²K)]	$U_w -$ [W/(m²K)]	
						$U_g = 1,1$	$U_g = 0,9$		$U_g = 0,7$	$U_g = 0,5$
91	1916009	55	1916105	30	2,0	1,5	1,3	1,9	1,1	0,97

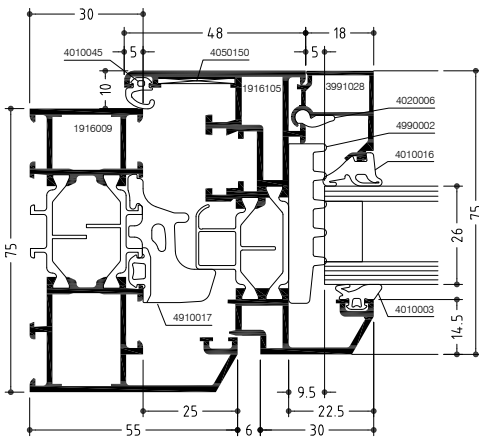

WICLINE 65

Klassik-Design mit Spezial-Dämmprofil Drehkipp -
Fenster mit Festverglasung

Classic design with special insulation profile - Turn/tilt window with fixed glazing

Wärmedämmung
Thermal insulation

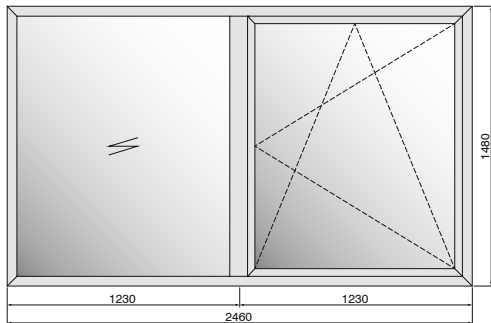

Ansichts- breite System width [mm]	Kämpfer Transom		Flügel Sash		Rahmen Nr. Frame No.	2-fach Glas Double glazing					3-fach Glas Triple glazing				
	Nr. No.	Breite Width [mm]	Nr. No.	Breite Width [mm]		U_t Kämpfer U_t transom	U_t Festfeld U_t fixed	U_t Flügel U_t sash	U_w - [W/(m²K)]		U_t Kämpfer U_t transom	U_t Festfeld U_t fixed	U_t Flügel U_t sash	U_w - [W/(m²K)]	
									U_g = 1,1	U_g = 0,9				U_g = 0,7	U_g = 0,5
116	1916334	80	1916105	30	1916009	2,0	1,8	2,0	1,4	1,2	1,9	1,7	1,9	1,0	0,85

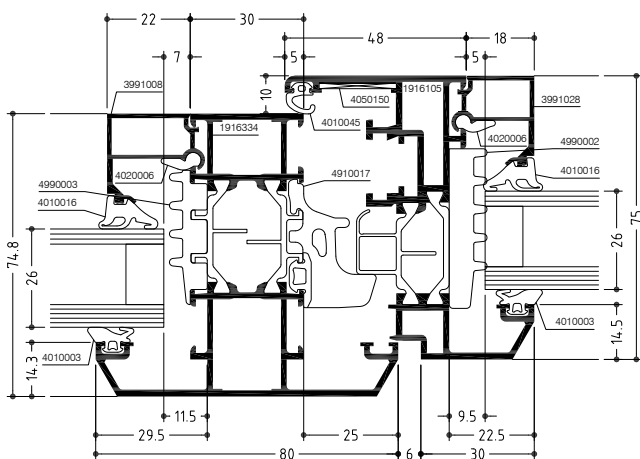

WICLINE 65

Schwing - Wende - Fenster
Horizontal/vertical pivot window

Wärmedämmung
Thermal insulation

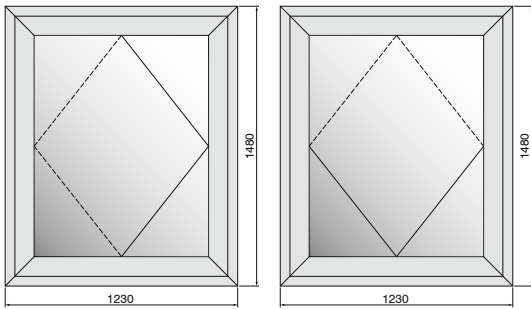

Ansichts- breite System width [mm]	Blendrahmen Frame		Flügel Sash		2-fach Glas Double glazing			3-fach Glas Triple glazing		
	Nr. No.	Breite Width [mm]	Nr. No.	Breite Width [mm]	$U_f -$ [W/(m²K)]	$U_w -$ [W/(m²K)] $U_g = 1,1$ $U_g = 0,9$		$U_f -$ [W/(m²K)]	$U_w -$ [W/(m²K)] $U_g = 0,7$ $U_g = 0,5$	
159	1916003	55	1916163	98	2,7	1,9	1,7	2,6	1,6	1,5
134	1916003	55	1916161	73	2,9	1,9	1,7	2,7	1,6	1,4

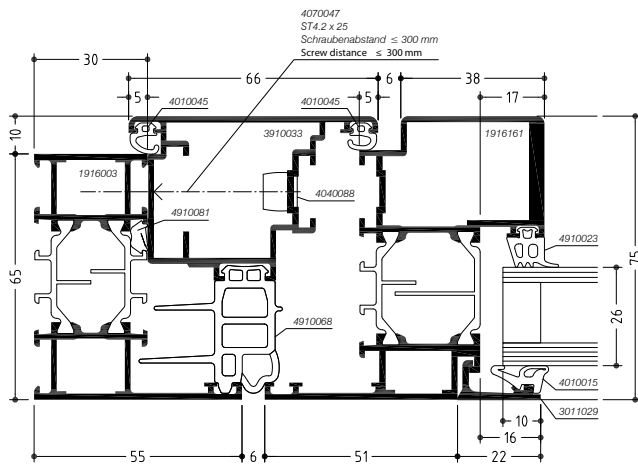

WICLINE 65

Senk - Klapp - Fenster

Lowering and projecting top-hung window

Wärmedämmung
Thermal insulation

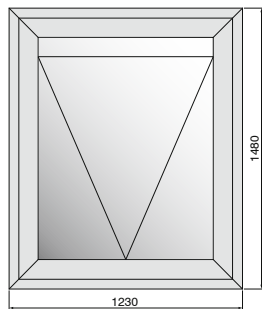

Ansichts- breite System width [mm]	Blendrahmen Frame		Flügel Sash		2-fach Glas Double glazing			3-fach Glas Triple glazing		
	Nr. No.	Breite Width [mm]	Nr. No.	Breite Width [mm]	U_i - [W/(m ² K)]	U_w - [W/(m ² K)] $U_g = 1,1$ $U_g = 0,9$		U_i - [W/(m ² K)]	U_w - [W/(m ² K)] $U_g = 0,7$ $U_g = 0,5$	
159	1916003	55	1916163	98	2,7	1,9	1,7	2,6	1,6	1,5
134	1916003	55	1916161	73	2,9	1,9	1,7	2,7	1,6	1,4

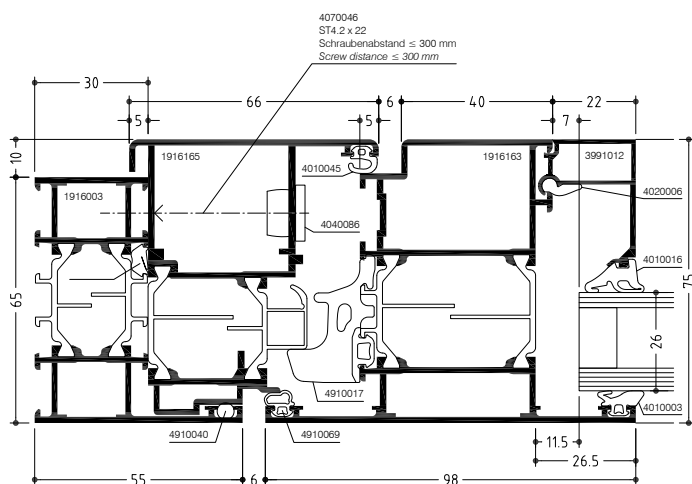

WICLINE 65

Klapp - Fenster
Top-hung window

Wärmedämmung
Thermal insulation

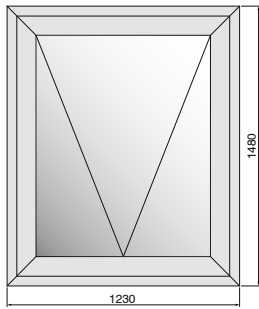

Ansichts- breite System width [mm]	Blendrahmen Frame		Flügel Sash		2-fach Glas Double glazing			3-fach Glas Triple glazing		
	Nr. No.	Breite Width [mm]	Nr. No.	Breite Width [mm]	U_i - [W/(m ² K)]	U_w - [W/(m ² K)] $U_g = 1,1$ $U_g = 0,9$		U_i - [W/(m ² K)]	U_w - [W/(m ² K)] $U_g = 0,7$ $U_g = 0,5$	
133	1916093	29	1916163	98	2,2	1,6	1,5	2,0	1,3	1,2
108	1916093	29	1916161	73	2,2	1,6	1,4	2,1	1,2	1,1

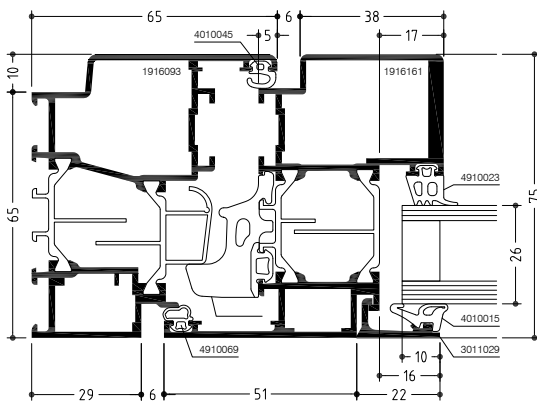

WICLINE 65

Spezial-Dämmprofil - Schwing - Wende - Fenster
Special insulation profile - Horizontal/vertical pivot window

Wärmedämmung
Thermal insulation

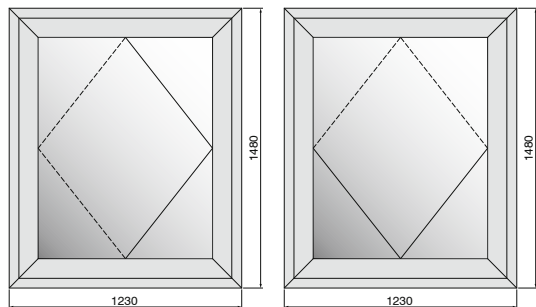

Ansichts- breite System width [mm]	Blendrahmen Frame		Flügel Sash		2-fach Glas Double glazing			3-fach Glas Triple glazing		
	Nr. No.	Breite Width [mm]	Nr. No.	Breite Width [mm]	$U_i -$ [W/(m²K)]	$U_w -$ [W/(m²K)] $U_g = 1,1$ $U_g = 0,9$		$U_i -$ [W/(m²K)]	$U_w -$ [W/(m²K)] $U_g = 0,7$ $U_g = 0,5$	
159	1916003	55	1916163	98	2,4	1,8	1,6	2,3	1,5	1,4

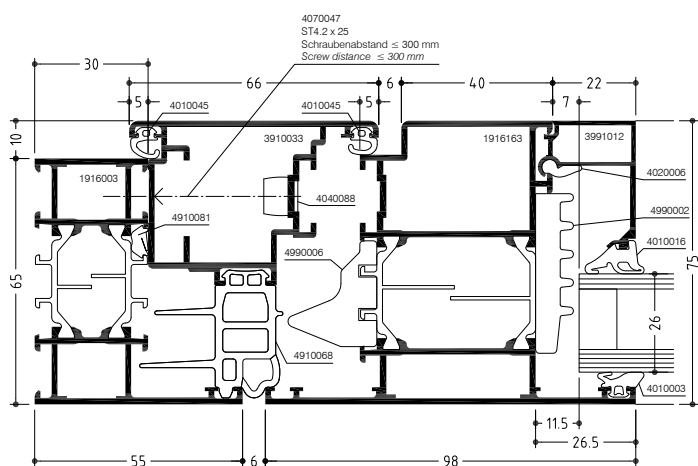

WICLINE 65

Spezial-Dämmprofil - Senk - Klapp - Fenster
 Special insulation profile - Lowering and projecting top-hung window

Wärmedämmung
 Thermal insulation

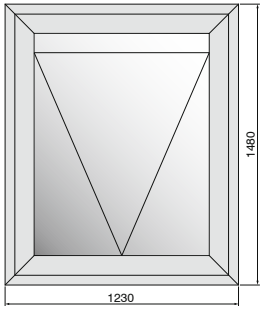

Ansichts- breite System width [mm]	Blendrahmen Frame		Flügel Sash		2-fach Glas Double glazing			3-fach Glas Triple glazing		
	Nr. No.	Breite Width [mm]	Nr. No.	Breite Width [mm]	$U_i -$ [W/(m²K)]	$U_w -$ [W/(m²K)] $U_g = 1,1$ $U_g = 0,9$		$U_i -$ [W/(m²K)]	$U_w -$ [W/(m²K)] $U_g = 0,7$ $U_g = 0,5$	
159	1916003	55	1916163	98	1,8	1,5	1,4	1,7	1,3	1,1

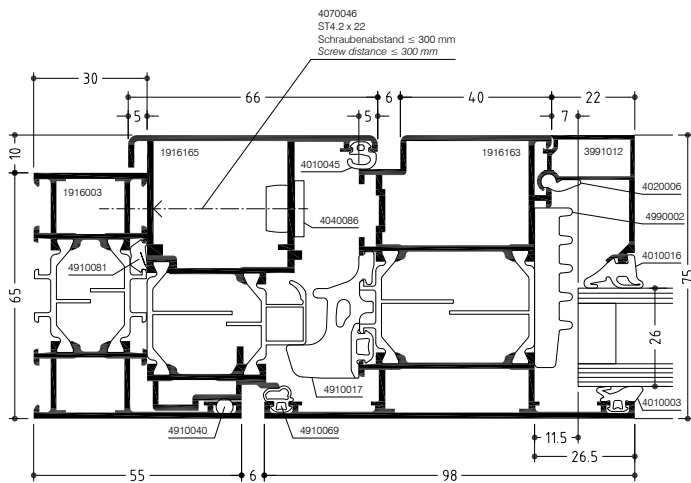

WICLINE 65

Spezial-Dämmprofil - Klapp - Fenster
Special insulation profile - Top-hung window

Wärmedämmung
Thermal insulation

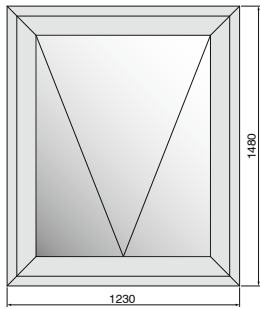

Ansichts- breite System width [mm]	Blendrahmen <i>Frame</i>		Flügel <i>Sash</i>		2-fach Glas <i>Double glazing</i>			3-fach Glas <i>Triple glazing</i>		
	Nr. No.	Breite Width [mm]	Nr. No.	Breite Width [mm]	$U_i -$ [W/(m²K)]	$U_w -$ [W/(m²K)]		$U_i -$ [W/(m²K)]	$U_w -$ [W/(m²K)]	
						$U_g = 1,1$	$U_g = 0,9$		$U_g = 0,7$	$U_g = 0,5$
133	1916093	29	1916163	98	1,9	1,5	1,4	1,8	1,2	1,1

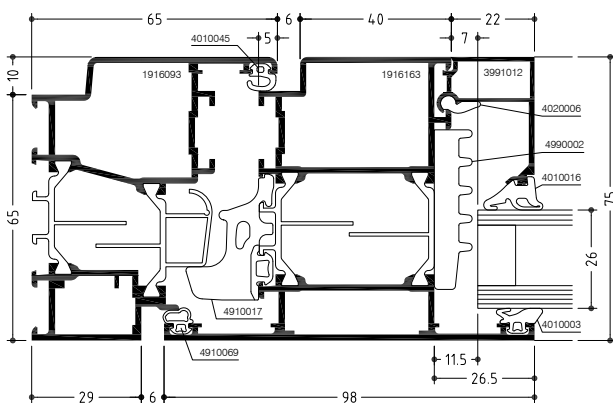

WICLINE 75

Festverglasung
Fixed glazing

Wärmedämmung
Thermal insulation

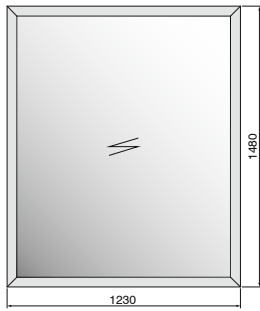

Ansichts- breite System width [mm]	Blendrahmen Frame		2-fach Glas Double glazing			3-fach Glas Triple glazing		
	Nr. No.	Breite Width [mm]	$U_f -$ [W/(m ² K)]	$U_w -$ [W/(m ² K)] $U_g = 1,1$ $U_g = 0,9$		$U_f -$ [W/(m ² K)]	$U_w -$ [W/(m ² K)] $U_g = 0,7$ $U_g = 0,5$	
48	1917001	48	2,5	1,4	1,2	2,3	1,0	0,84
52	1917002	52	2,4	1,4	1,2	2,2	1,0	0,85
55	1917003	55	2,3	1,4	1,2	2,1	1,0	0,84
65	1917004	65	2,1	1,4	1,2	1,9	1,0	0,85
75	1917005	75	1,9	1,4	1,2	1,7	1,0	0,84

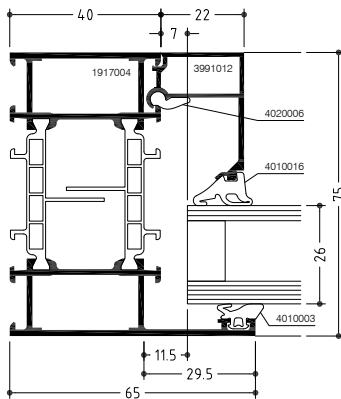

WICLINE 75

Drehkipp-Fenster
Turn/tilt window

Wärmedämmung
Thermal insulation

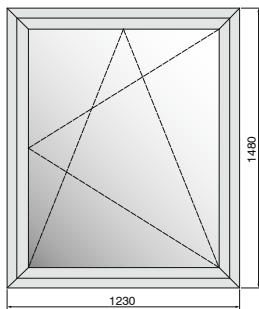

Ansichts- breite System width [mm]	Blendrahmen Frame		Flügel Sash		2-fach Glas Double glazing			3-fach Glas Triple glazing		
	Nr. No.	Breite Width [mm]	Nr. No.	Breite Width [mm]	$U_i -$ [W/(m²K)]	$U_w -$ [W/(m²K)]		$U_i -$ [W/(m²K)]	$U_w -$ [W/(m²K)]	
						$U_g = 1,1$	$U_g = 0,9$		$U_g = 0,7$	$U_g = 0,5$
88	1917001	48	1917101	34	2,1	1,5	1,3	1,9	1,1	0,98
95	1917001	48	1917102	41	2,1	1,5	1,3	1,9	1,2	1,0
105	1917001	48	1917103	51	2,0	1,5	1,3	1,8	1,2	1,0
115	1917001	48	1917104	61	2,0	1,5	1,3	1,8	1,2	1,1
92	1917002	52	1917101	34	2,1	1,5	1,3	1,9	1,2	1,0
99	1917002	52	1917102	41	2,0	1,5	1,3	1,8	1,2	1,0
109	1917002	52	1917103	51	1,9	1,5	1,3	1,7	1,2	1,0
119	1917002	52	1917104	61	1,8	1,4	1,3	1,6	1,2	1,0
95	1917003	55	1917101	34	2,1	1,5	1,3	1,9	1,2	1,0
102	1917003	55	1917102	41	2,0	1,5	1,3	1,8	1,2	1,0
112	1917003	55	1917103	51	1,9	1,5	1,3	1,7	1,2	1,0
122	1917003	55	1917104	61	1,8	1,5	1,3	1,6	1,2	1,0
105	1917004	65	1917101	34	2,0	1,5	1,3	1,8	1,2	1,0
112	1917004	65	1917102	41	1,9	1,5	1,3	1,7	1,2	1,0
122	1917004	65	1917103	51	1,8	1,5	1,3	1,6	1,2	1,0
132	1917004	65	1917104	61	1,8	1,5	1,3	1,6	1,2	1,0
115	1917005	75	1917101	34	1,9	1,5	1,3	1,7	1,2	1,0
122	1917005	75	1917102	41	1,8	1,5	1,3	1,6	1,2	1,0
132	1917005	75	1917103	51	1,8	1,5	1,3	1,6	1,2	1,0
142	1917005	75	1917104	61	1,7	1,4	1,3	1,5	1,2	1,0

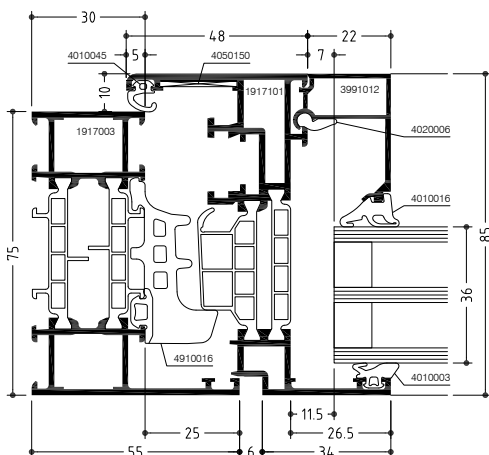

WICLINE 75

Drehkipp - Fenster mit Festverglasung
Turn/tilt window with fixed glazing

Wärmedämmung
Thermal insulation

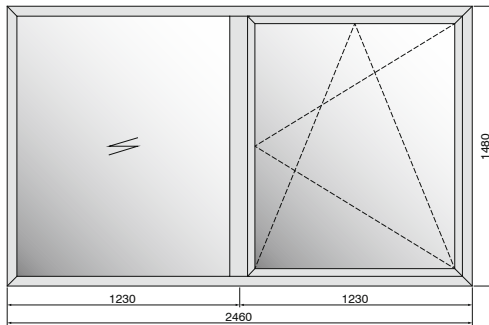

Ansichts- breite System width [mm]	Kämpfer Transom		Flügel Sash		Rahmen Nr. Frame No.	2-fach Glas Double glazing					3-fach Glas Triple glazing				
	Nr. No.	Breite Width [mm]	Nr. No.	Breite Width [mm]		U_i Kämpfer U_i transom	U_i Festfeld U_i fixed	U_i Flügel U_i sash	U_w - [W/(m²K)]		U_i Kämpfer U_i transom	U_i Festfeld U_i fixed	U_i Flügel U_i sash	U_w - [W/(m²K)]	
									$U_g = 1,1$	$U_g = 0,9$				$U_g = 0,7$	$U_g = 0,5$
120	1917203	80	1917101	34	1917001	2,2	2,5	2,1	1,4	1,3	2,0	2,3	1,9	1,1	0,88
127	1917203	80	1917102	41	1917001	2,1	2,5	2,1	1,4	1,3	1,9	2,3	1,9	1,1	0,88
137	1917203	80	1917103	51	1917001	2,1	2,5	2,0	1,4	1,3	1,9	2,3	1,8	1,1	0,89
147	1917203	80	1917104	61	1917001	2,0	2,5	2,0	1,5	1,3	1,8	2,3	1,8	1,1	0,90
130	1917204	90	1917101	34	1917002	2,1	2,4	2,1	1,4	1,3	1,9	2,2	1,9	1,1	0,88
137	1917204	90	1917102	41	1917002	2,1	2,4	2,0	1,4	1,3	1,9	2,2	1,8	1,1	0,89
147	1917204	90	1917103	51	1917002	2,0	2,4	1,9	1,4	1,3	1,8	2,2	1,7	1,1	0,89
157	1917204	90	1917104	61	1917002	2,0	2,4	1,8	1,4	1,3	1,8	2,2	1,6	1,1	0,89
140	1917205	100	1917101	34	1917003	2,1	2,3	2,1	1,5	1,3	1,9	2,1	1,9	1,1	0,89
147	1917205	100	1917102	41	1917003	2,0	2,3	2,0	1,4	1,3	1,8	2,1	1,8	1,1	0,89
157	1917205	100	1917103	51	1917003	2,0	2,3	1,9	1,4	1,3	1,8	2,1	1,7	1,1	0,89
167	1917205	100	1917104	61	1917003	2,0	2,3	1,8	1,4	1,3	1,8	2,1	1,6	1,1	0,90
150	1917206	110	1917101	34	1917004	2,0	2,1	2,0	1,4	1,3	1,8	1,9	1,8	1,1	0,89
157	1917206	110	1917102	41	1917004	2,0	2,1	1,9	1,4	1,3	1,8	1,9	1,7	1,1	0,89
167	1917206	110	1917103	51	1917004	2,0	2,1	1,8	1,4	1,3	1,8	1,9	1,6	1,1	0,90
177	1917206	110	1917104	61	1917004	1,9	2,1	1,8	1,4	1,3	1,7	1,9	1,6	1,1	0,90
160	1917207	120	1917101	34	1917005	2,0	1,9	1,9	1,4	1,3	1,8	1,7	1,7	1,1	0,89
167	1917207	120	1917102	41	1917005	2,0	1,9	1,8	1,4	1,3	1,8	1,7	1,6	1,1	0,90
177	1917207	120	1917103	51	1917005	1,9	1,9	1,8	1,4	1,3	1,7	1,7	1,6	1,1	0,90
187	1917207	120	1917104	61	1917005	1,9	1,9	1,7	1,4	1,3	1,7	1,7	1,5	1,1	0,90

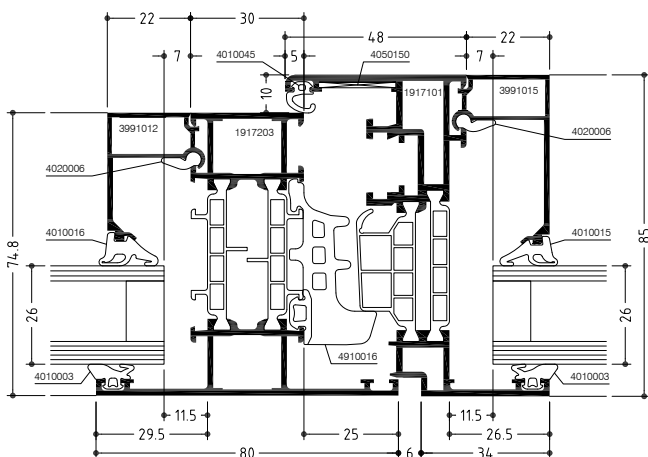

WICLINE 75

Spezial-Dämmprofil - Festverglasung
Special insulation profile - Fixed glazing

Wärmedämmung
Thermal insulation

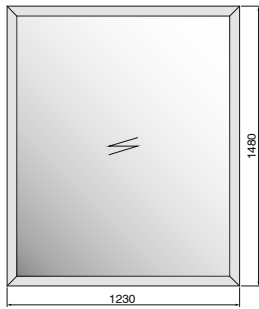

Ansichts- breite System width [mm]	Blendrahmen <i>Frame</i>		2-fach Glas <i>Double glazing</i>			3-fach Glas <i>Triple glazing</i>		
	Nr. <i>No.</i>	Breite Width [mm]	$U_f -$ [W/(m ² K)]	$U_w -$ [W/(m ² K)] $U_g = 1,1$ $U_g = 0,9$		$U_f -$ [W/(m ² K)]	$U_w -$ [W/(m ² K)] $U_g = 0,7$ $U_g = 0,5$	
48	1917001	48	1,5	1,3	1,1	1,4	0,91	0,72
52	1917002	52	1,5	1,3	1,1	1,4	0,91	0,73
55	1917003	55	1,4	1,3	1,1	1,3	0,90	0,72
65	1917004	65	1,4	1,3	1,1	1,3	0,92	0,74
75	1917005	75	1,3	1,3	1,1	1,2	0,91	0,74

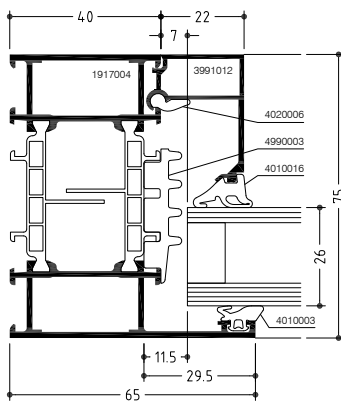

WICLINE 75

Spezial-Dämmprofil - Drehkipp-Fenster
Special insulation profile - Turn/tilt window

Wärmedämmung
Thermal insulation

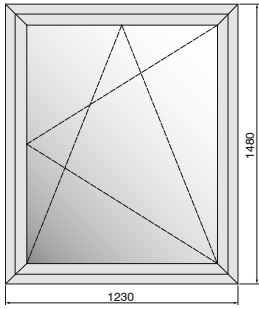

Ansichts- breite System width [mm]	Blendrahmen Frame		Flügel Sash		2-fach Glas Double glazing			3-fach Glas Triple glazing		
	Nr. No.	Breite Width [mm]	Nr. No.	Breite Width [mm]	$U_i -$ [W/(m ² K)]	$U_w -$ [W/(m ² K)] $U_g = 1,1$ $U_g = 0,9$		$U_i -$ [W/(m ² K)]	$U_w -$ [W/(m ² K)] $U_g = 0,7$ $U_g = 0,5$	
88	1917001	48	1917101	34	1,7	1,4	1,2	1,6	1,0	0,88
95	1917001	48	1917102	41	1,7	1,4	1,2	1,6	1,1	0,90
105	1917001	48	1917103	51	1,7	1,4	1,2	1,6	1,1	0,93
115	1917001	48	1917104	61	1,7	1,4	1,2	1,6	1,1	0,96
92	1917002	52	1917101	34	1,6	1,4	1,2	1,5	1,0	0,87
99	1917002	52	1917102	41	1,6	1,4	1,2	1,5	1,0	0,89
109	1917002	52	1917103	51	1,5	1,3	1,2	1,4	1,0	0,88
119	1917002	52	1917104	61	1,5	1,4	1,2	1,4	1,1	0,91
95	1917003	55	1917101	34	1,6	1,4	1,2	1,5	1,0	0,88
102	1917003	55	1917102	41	1,5	1,3	1,2	1,4	1,0	0,87
112	1917003	55	1917103	51	1,5	1,3	1,2	1,4	1,0	0,89
122	1917003	55	1917104	61	1,5	1,4	1,2	1,4	1,1	0,91
105	1917004	65	1917101	34	1,5	1,3	1,2	1,4	1,0	0,87
112	1917004	65	1917102	41	1,5	1,3	1,2	1,4	1,0	0,89
122	1917004	65	1917103	51	1,5	1,4	1,2	1,4	1,1	0,91
132	1917004	65	1917104	61	1,4	1,3	1,2	1,3	1,0	0,90
115	1917005	75	1917101	34	1,5	1,3	1,2	1,4	1,0	0,90
122	1917005	75	1917102	41	1,5	1,4	1,2	1,4	1,1	0,91
132	1917005	75	1917103	51	1,4	1,3	1,2	1,3	1,0	0,90
142	1917005	75	1917104	61	1,4	1,3	1,2	1,3	1,1	0,92

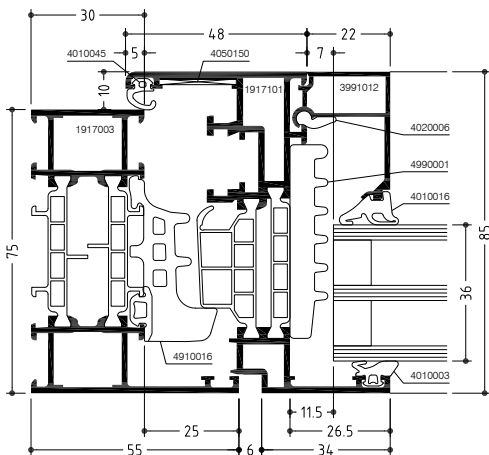

WICLINE 75

Spezial-Dämmprofil - Drehkipp - Fenster mit Festverglasung
 Special insulation profile - Turn/tilt window with fixed glazing

Wärmedämmung
 Thermal insulation

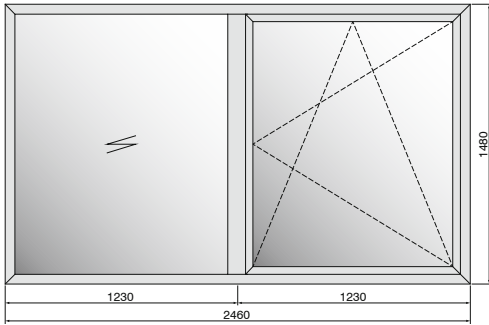

Ansichts- breite System width [mm]	Kämpfer Transom		Flügel Sash		Rahmen Nr. Frame No.	2-fach Glas Double glazing					3-fach Glas Triple glazing				
	Nr. No.	Breite Width [mm]	Nr. No.	Breite Width [mm]		U_t Kämpfer U_t transom	U_t Festfeld U_t fixed	U_t Flügel U_t sash	U_w - [W/(m²K)]		U_t Kämpfer U_t transom	U_t Festfeld U_t fixed	U_t Flügel U_t sash	U_w - [W/(m²K)]	
									$U_g = 1,1$	$U_g = 0,9$				$U_g = 0,7$	$U_g = 0,5$
120	1917203	80	1917101	34	1917001	1,6	1,5	1,7	1,3	1,1	1,5	1,4	1,6	0,96	0,78
127	1917203	80	1917102	41	1917001	1,5	1,5	1,7	1,3	1,1	1,4	1,4	1,6	0,96	0,78
137	1917203	80	1917103	51	1917001	1,5	1,5	1,7	1,3	1,1	1,4	1,4	1,6	0,97	0,80
147	1917203	80	1917104	61	1917001	1,5	1,5	1,7	1,3	1,2	1,4	1,4	1,6	0,98	0,81
130	1917204	90	1917101	34	1917002	1,5	1,5	1,6	1,3	1,1	1,4	1,4	1,5	0,95	0,78
137	1917204	90	1917102	41	1917002	1,5	1,5	1,6	1,3	1,1	1,4	1,4	1,5	0,96	0,79
147	1917204	90	1917103	51	1917002	1,5	1,5	1,5	1,3	1,1	1,4	1,4	1,4	0,96	0,79
157	1917204	90	1917104	61	1917002	1,5	1,5	1,5	1,3	1,1	1,4	1,4	1,4	0,97	0,80
140	1917205	100	1917101	34	1917003	1,5	1,4	1,6	1,3	1,1	1,4	1,3	1,5	0,95	0,78
147	1917205	100	1917102	41	1917003	1,5	1,4	1,5	1,3	1,1	1,4	1,3	1,4	0,95	0,78
157	1917205	100	1917103	51	1917003	1,5	1,4	1,5	1,3	1,1	1,4	1,3	1,4	0,96	0,79
167	1917205	100	1917104	61	1917003	1,5	1,4	1,5	1,3	1,1	1,4	1,3	1,4	0,97	0,80
150	1917206	110	1917101	34	1917004	1,5	1,4	1,5	1,3	1,1	1,4	1,3	1,4	0,96	0,79
157	1917206	110	1917102	41	1917004	1,5	1,4	1,5	1,3	1,1	1,4	1,3	1,4	0,96	0,80
167	1917206	110	1917103	51	1917004	1,5	1,4	1,5	1,3	1,1	1,4	1,3	1,4	0,97	0,81
177	1917206	110	1917104	61	1917004	1,5	1,4	1,4	1,3	1,1	1,4	1,3	1,3	0,97	0,80
160	1917207	120	1917101	34	1917005	1,5	1,3	1,5	1,3	1,1	1,4	1,2	1,4	0,96	0,80
167	1917207	120	1917102	41	1917005	1,5	1,3	1,5	1,3	1,1	1,4	1,2	1,4	0,97	0,81
177	1917207	120	1917103	51	1917005	1,5	1,3	1,4	1,3	1,1	1,4	1,2	1,3	0,96	0,80
187	1917207	120	1917104	61	1917005	1,5	1,3	1,4	1,3	1,1	1,4	1,2	1,3	0,97	0,81

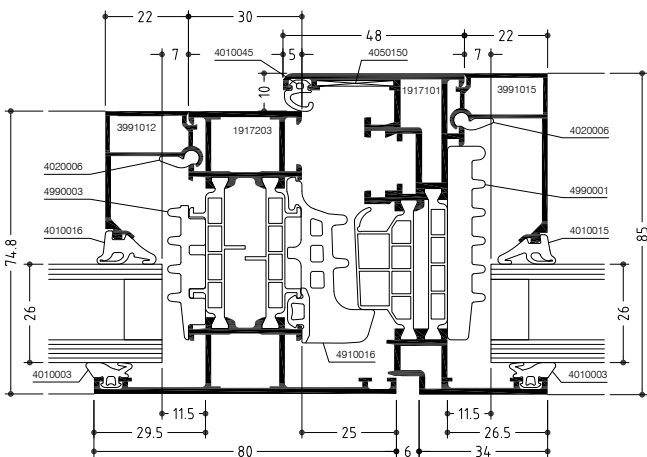

WICLINE 75

Verdeckter Flügel - Festverglasung
Concealed sash profile - Fixed glazing

Wärmedämmung
Thermal insulation

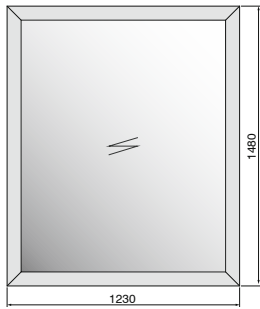

Ansichts- breite System width [mm]	Blendrahmen Frame		U_i – [W/(m²K)]	2-fach Glas Double glazing		3-fach Glas Triple glazing	
	Nr. No.	Breite Width [mm]		U_w – [W/(m²K)]		U_w – [W/(m²K)]	
				$U_g = 1,1$	$U_g = 0,9$	$U_g = 0,7$	$U_g = 0,5$
74	1917081	74	1,2	1,3	1,1	0,91	0,74
84	1917082	84	1,2	1,3	1,1	0,92	0,75
84	1917086	84	1,2	1,3	1,1	0,92	0,75

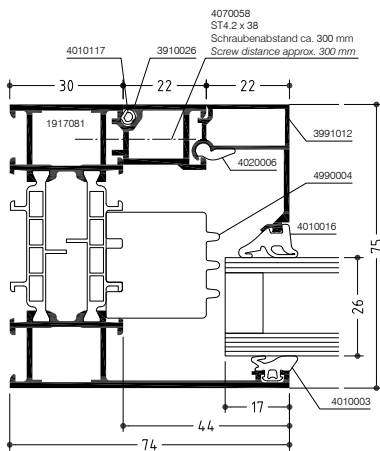

WICLINE 75

Verdeckter Flügel - Drehkipp-Fenster
Concealed sash profile - Turn/tilt window

Wärmedämmung
Thermal insulation

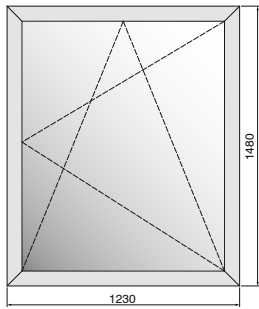

Ansichts- breite System width [mm]	Blendrahmen <i>Frame</i>		Flügel <i>Sash</i>		U_i – [W/(m ² K)]	2-fach Glas <i>Double glazing</i>		3-fach Glas <i>Triple glazing</i>	
	Nr. <i>No.</i>	Breite Width [mm]	Nr. <i>No.</i>	Breite Width [mm]		U_w – [W/(m ² K)]		U_w – [W/(m ² K)]	
						$U_g = 1,1$	$U_g = 0,9$	$U_g = 0,7$	$U_g = 0,5$
80	1917081	74	1917110	6	1,8	1,4	1,2	1,1	0,88
80	1917081	74	1917111	6	1,8	1,4	1,2	1,1	0,88
90	1917081	74	1917112	16	1,8	1,4	1,2	1,1	0,91
90	1917081	74	1917113	16	1,8	1,4	1,2	1,1	0,91
90	1917082	84	1917110	6	1,8	1,4	1,2	1,1	0,91
90	1917082	84	1917111	6	1,8	1,4	1,2	1,1	0,91
100	1917082	84	1917112	16	1,8	1,4	1,2	1,1	0,94
100	1917082	84	1917113	16	1,8	1,4	1,2	1,1	0,94
90	1917086	84	1917110	6	1,8	1,4	1,2	1,1	0,91
90	1917086	84	1917111	6	1,8	1,4	1,2	1,1	0,91
100	1917086	84	1917112	16	1,8	1,4	1,2	1,1	0,94
100	1917086	84	1917113	16	1,8	1,4	1,2	1,1	0,94

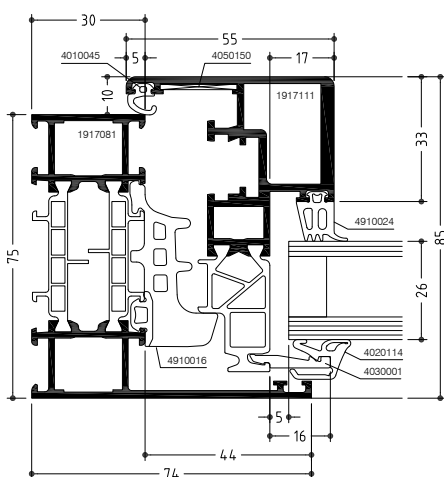

WICLINE 75

Verdeckter Flügel - Drehkipp - Fenster mit Festverglasung
 Concealed sash profile - Turn/tilt window with fixed glazing

Wärmedämmung
 Thermal insulation

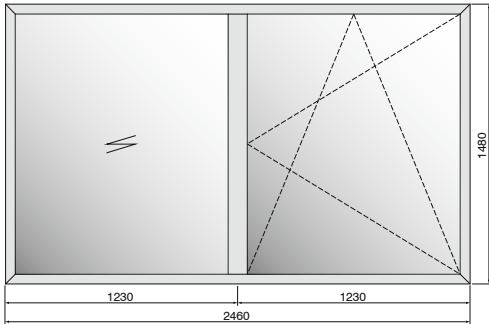

Ansichts- breite System width [mm]	Kämpfer <i>Transom</i>		Flügel <i>Sash</i>		Rahmen Nr. <i>Frame No.</i>	U_f Kämpfer U_f <i>transom</i>	U_f Festfeld U_f <i>fixed</i>	U_f Flügel U_f <i>sash</i>	2-fach Glas <i>Double glazing</i>		3-fach Glas <i>Triple glazing</i>	
	Nr. <i>No.</i>	Breite Width [mm]	Nr. <i>No.</i>	Breite Width [mm]					U_w - [W/(m²K)]		U_w - [W/(m²K)]	
									$U_g = 1,1$	$U_g = 0,9$	$U_g = 0,7$	$U_g = 0,5$
102	1917235	90	1917110	6	1917081	1,8	1,2	1,8	1,3	1,1	0,98	0,80
102	1917235	90	1917111	6	1917081	1,8	1,2	1,8	1,3	1,1	0,98	0,80
112	1917235	90	1917112	16	1917081	1,8	1,2	1,8	1,3	1,1	0,99	0,82
112	1917235	90	1917113	16	1917081	1,8	1,2	1,8	1,3	1,1	0,99	0,82
130	1917231	118	1917110	6	1917082	1,8	1,2	1,8	1,3	1,2	1,0	0,83
130	1917231	118	1917111	6	1917082	1,8	1,2	1,8	1,3	1,2	1,0	0,83
140	1917231	118	1917112	16	1917082	1,8	1,2	1,8	1,3	1,2	1,0	0,85
140	1917231	118	1917113	16	1917082	1,8	1,2	1,8	1,3	1,2	1,0	0,85

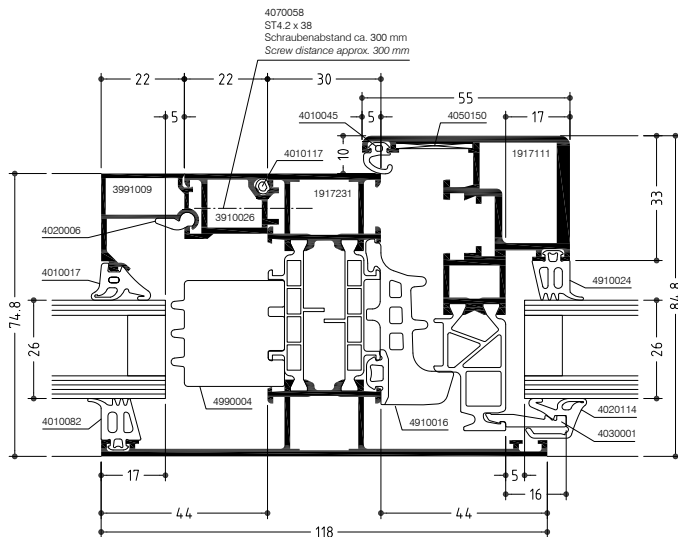

WICLINE 75

Klassik-Design - Festverglasung
 Classic design - Fixed glazing

Wärmedämmung
 Thermal insulation

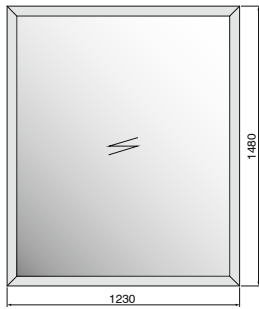

Ansichts- breite System width [mm]	Blendrahmen Frame		2-fach Glas Double glazing			3-fach Glas Triple glazing		
	Nr. No.	Breite Width [mm]	U_f - [W/(m²K)]	U_w - [W/(m²K)]		U_f - [W/(m²K)]	U_w - [W/(m²K)]	
				$U_g = 1,1$	$U_g = 0,9$		$U_g = 0,7$	$U_g = 0,5$
55	1917009	55	2,4	1,4	1,2	2,2	1,0	0,86

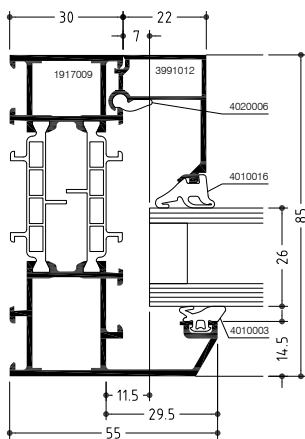

WICLINE 75

Klassik-Design - Drehkipp-Fenster
 Classic design - Turn/tilt window

Wärmedämmung
 Thermal insulation

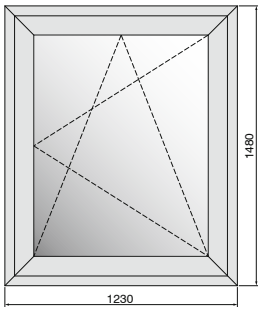

Ansichts- breite System width [mm]	Blendrahmen Frame		Flügel Sash		2-fach Glas Double glazing			3-fach Glas Triple glazing		
	Nr. No.	Breite Width [mm]	Nr. No.	Breite Width [mm]	U_i – [W/(m²K)]	U_w – [W/(m²K)] $U_g = 1,1$ $U_g = 0,9$		U_i – [W/(m²K)]	U_w – [W/(m²K)] $U_g = 0,7$ $U_g = 0,5$	
91	1917009	55	1917105	30	1,9	1,4	1,3	1,7	1,1	0,94

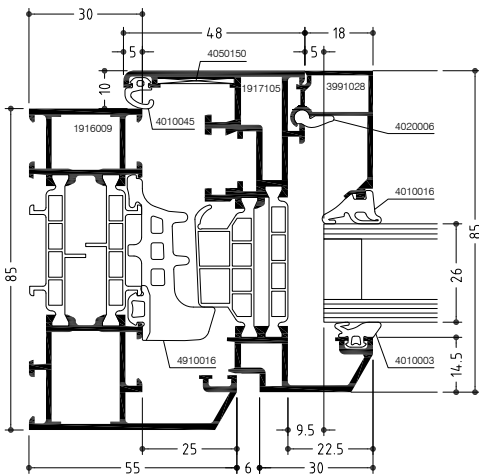

WICLINE 75

Klassik-Design - Drehkipp - Fenster mit Festverglasung
 Classic design - Turn/tilt window with fixed glazing

Wärmedämmung
 Thermal insulation

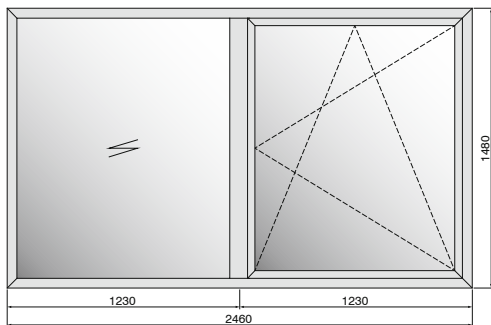

Ansichts- breite System width [mm]	Kämpfer <i>Transom</i>		Flügel <i>Sash</i>		Rahmen Nr. <i>Frame No.</i>	2-fach Glas <i>Double glazing</i>					3-fach Glas <i>Triple glazing</i>				
	Nr. <i>No.</i>	Breite Width [mm]	Nr. <i>No.</i>	Breite Width [mm]		U_t Kämpfer U_t <i>transom</i>	U_t Festfeld U_t <i>fixed</i>	U_t Flügel U_t <i>sash</i>	$U_w - [W/(m^2K)]$		U_t Kämpfer U_t <i>transom</i>	U_t Festfeld U_t <i>fixed</i>	U_t Flügel U_t <i>sash</i>	$U_w - [W/(m^2K)]$	
									$U_g = 1,1$	$U_g = 0,9$				$U_g = 0,7$	$U_g = 0,5$
116	1917334	80	1917105	30	1917009	1,9	2,4	1,9	1,4	1,2	1,7	2,2	1,7	1,0	0,85

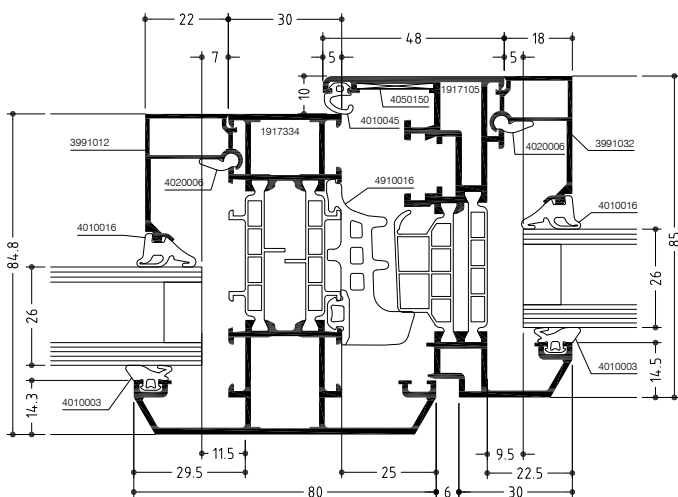

WICLINE 75

Klassik-Design mit Spezial-Dämmprofil - Festverglasung
 Classic design with special insulation profile - Fixed glazing

Wärmedämmung
 Thermal insulation

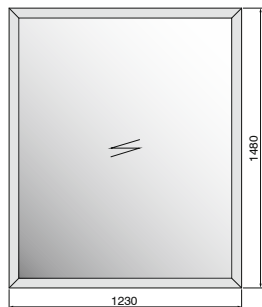

Ansichts- breite System width [mm]	Blendrahmen Frame		2-fach Glas Double glazing			3-fach Glas Triple glazing		
	Nr. No.	Breite Width [mm]	U_f - [W/(m²K)]	U_w - [W/(m²K)]		U_f - [W/(m²K)]	U_w - [W/(m²K)]	
				$U_g = 1,1$	$U_g = 0,9$		$U_g = 0,7$	$U_g = 0,5$
55	1917009	55	1,7	1,3	1,1	1,4	0,92	0,73

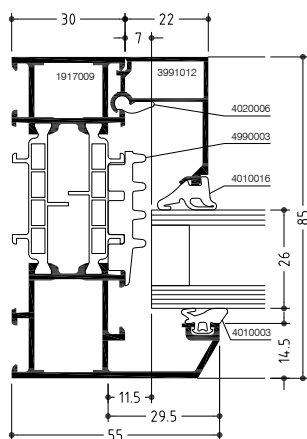

WICLINE 75

Klassik-Design mit Spezialdämmprofil - Drehkipp-Fenster
 Classic design with special insulation profile - Turn/tilt window

Wärmedämmung
 Thermal insulation

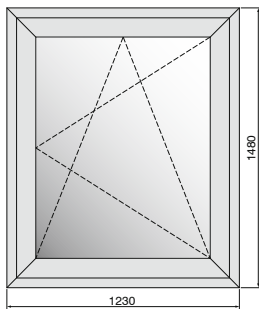

Ansichts- breite System width [mm]	Blendrahmen Frame		Flügel Sash		2-fach Glas Double glazing			3-fach Glas Triple glazing		
	Nr. No.	Breite Width [mm]	Nr. No.	Breite Width [mm]	U_i - [W/(m ² K)]	U_w - [W/(m ² K)] $U_g = 1,1$ $U_g = 0,9$		U_i - [W/(m ² K)]	U_w - [W/(m ² K)] $U_g = 0,7$ $U_g = 0,5$	
91	1917009	55	1917105	30	1,5	1,3	1,2	1,4	1,0	0,84

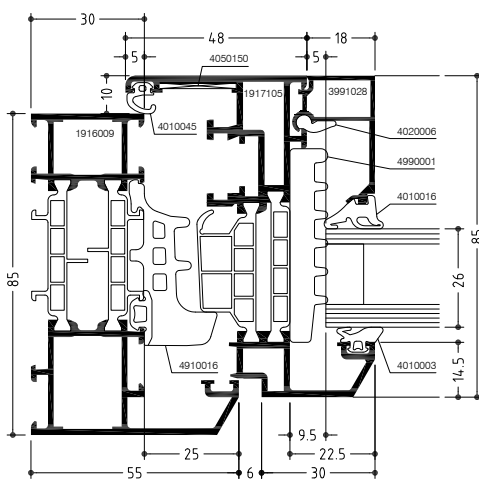

WICLINE 75

Klassik-Design mit Spezial-Dämmprofil Drehkipp -
Fenster mit Festverglasung

Classic design with special insulation profile - Turn/tilt window with fixed glazing

Wärmedämmung
Thermal insulation

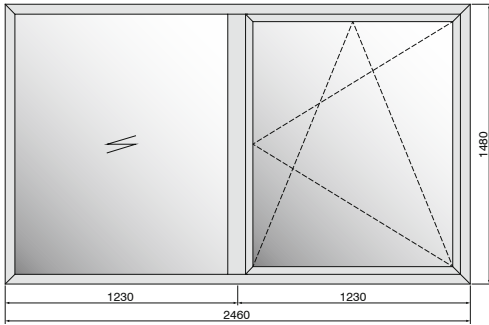

Ansichts- breite System width [mm]	Kämpfer <i>Transom</i>		Flügel <i>Sash</i>		Rahmen Nr. <i>Frame No.</i>	2-fach Glas <i>Double glazing</i>					3-fach Glas <i>Triple glazing</i>				
	Nr. <i>No.</i>	Breite Width [mm]	Nr. <i>No.</i>	Breite Width [mm]		U_t Kämpfer U_t <i>transom</i>	U_t Festfeld U_t <i>fixed</i>	U_t Flügel U_t <i>sash</i>	$U_w - [W/(m^2K)]$		U_t Kämpfer U_t <i>transom</i>	U_t Festfeld U_t <i>fixed</i>	U_t Flügel U_t <i>sash</i>	$U_w - [W/(m^2K)]$	
									$U_g = 1,1$	$U_g = 0,9$				$U_g = 0,7$	$U_g = 0,5$
116	1917334	80	1917105	30	1917009	1,5	1,7	1,5	1,3	1,1	1,4	1,4	1,5	0,95	0,77

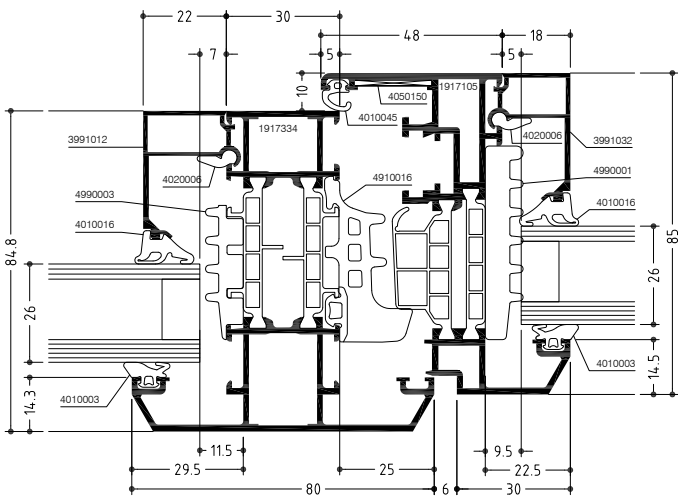

WICLINE 75

Schwing - Wende - Fenster
Horizontal/vertical pivot window

Wärmedämmung
Thermal insulation

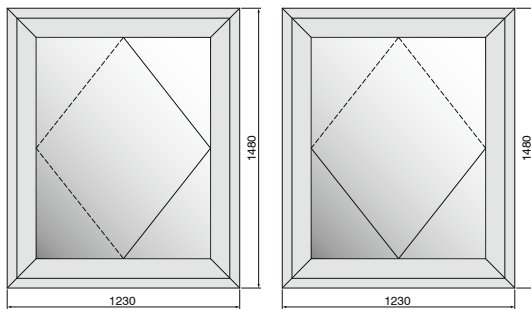

Ansichts- breite System width [mm]	Blendrahmen Frame		Flügel Sash		2-fach Glas Double glazing			3-fach Glas Triple glazing		
	Nr. No.	Breite Width [mm]	Nr. No.	Breite Width [mm]	$U_i -$ [W/(m ² K)]	$U_w -$ [W/(m ² K)] $U_g = 1,1$ $U_g = 0,9$		$U_i -$ [W/(m ² K)]	$U_w -$ [W/(m ² K)] $U_g = 0,7$ $U_g = 0,5$	
159	1917003	55	1917163	98	1,8	1,5	1,4	1,6	1,3	1,1
134	1917003	55	1917161	73	1,7	1,4	1,3	1,5	1,2	1,0

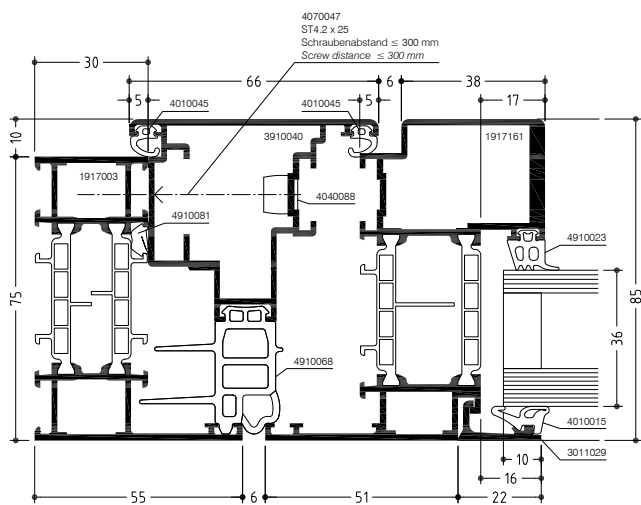

WICLINE 75

Senk - Klapp - Fenster

Lowering and projecting top-hung window

Wärmedämmung
Thermal insulation

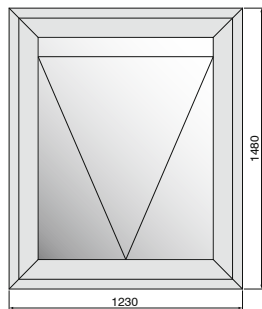

Ansichts- breite System width [mm]	Blendrahmen Frame		Flügel Sash		2-fach Glas Double glazing			3-fach Glas Triple glazing		
	Nr. No.	Breite Width [mm]	Nr. No.	Breite Width [mm]	U_i - [W/(m ² K)]	U_w - [W/(m ² K)] $U_g = 1,1$ $U_g = 0,9$		U_i - [W/(m ² K)]	U_w - [W/(m ² K)] $U_g = 0,7$ $U_g = 0,5$	
159	1917003	55	1917163	98	1,8	1,5	1,4	1,6	1,3	1,1
134	1917003	55	1917161	73	1,7	1,4	1,3	1,5	1,2	1,0

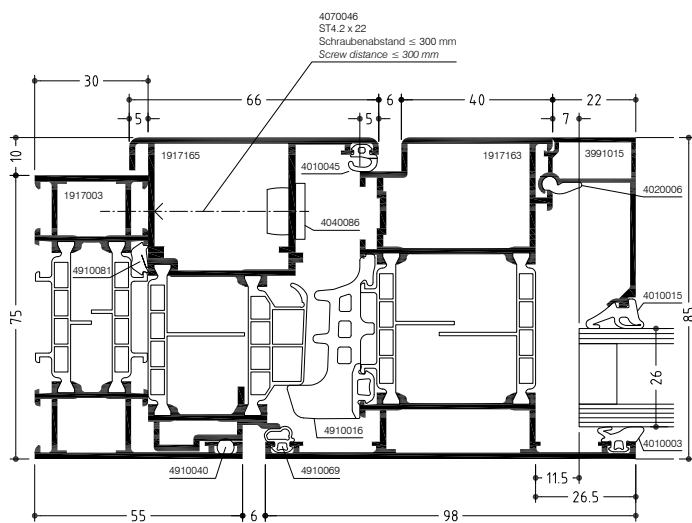

WICLINE 75

Klapp - Fenster
Top-hung window

Wärmedämmung
Thermal insulation

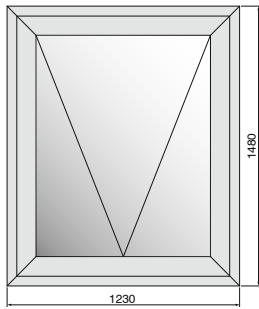

Ansichts- breite System width [mm]	Blendrahmen Frame		Flügel Sash		2-fach Glas Double glazing			3-fach Glas Triple glazing		
	Nr. No.	Breite Width [mm]	Nr. No.	Breite Width [mm]	U_i - [W/(m ² K)]	U_w - [W/(m ² K)] $U_g = 1,1$ $U_g = 0,9$		U_i - [W/(m ² K)]	U_w - [W/(m ² K)] $U_g = 0,7$ $U_g = 0,5$	
133	1917093	29	1917163	98	1,8	1,5	1,3	1,6	1,2	1,0
108	1917093	29	1917161	73	1,7	1,4	1,2	1,5	1,1	0,94

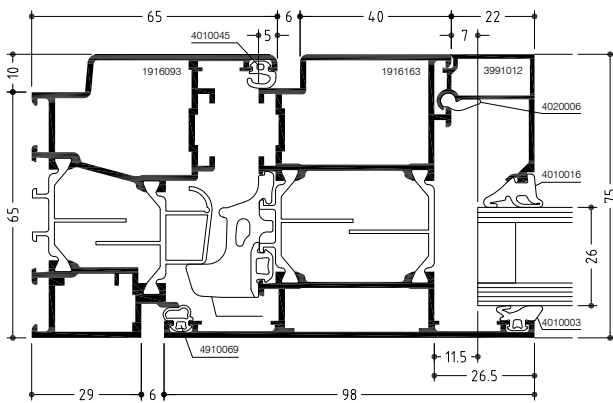

WICLINE 75

Spezial-Dämmprofil - Schwing - Wende - Fenster
 Special insulation profile - Horizontal/vertical pivot window

Wärmedämmung
 Thermal insulation

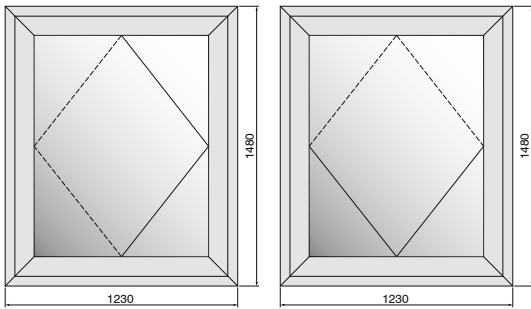

Ansichts- breite System width [mm]	Blendrahmen Frame		Flügel Sash		2-fach Glas Double glazing			3-fach Glas Triple glazing		
	Nr. No.	Breite Width [mm]	Nr. No.	Breite Width [mm]	$U_i -$ [W/(m ² K)]	$U_w -$ [W/(m ² K)] $U_g = 1,1$ $U_g = 0,9$		$U_i -$ [W/(m ² K)]	$U_w -$ [W/(m ² K)] $U_g = 0,7$ $U_g = 0,5$	
159	1917003	55	1917163	98	1,5	1,4	1,2	1,4	1,1	1,0

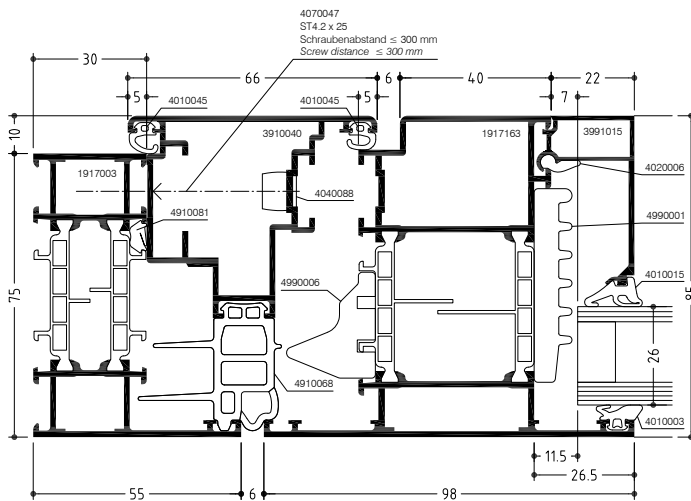

WICLINE 75

Spezial-Dämmprofil - Senk - Klapp - Fenster
 Special insulation profile - Lowering and projecting top-hung window

Wärmedämmung
 Thermal insulation

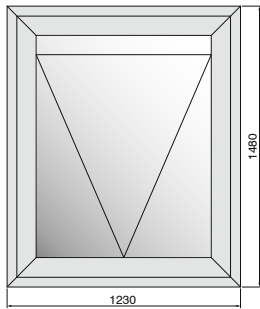

Ansichtsbreite System width [mm]	Blendrahmen Frame		Flügel Sash		2-fach Glas Double glazing			3-fach Glas Triple glazing		
	Nr. No.	Breite Width [mm]	Nr. No.	Breite Width [mm]	U_i - [W/(m ² K)]	U_w - [W/(m ² K)] $U_g = 1,1$ $U_g = 0,9$		U_i - [W/(m ² K)]	U_w - [W/(m ² K)] $U_g = 0,7$ $U_g = 0,5$	
159	1917003	55	1917163	98	1,5	1,4	1,2	1,4	1,1	1,0

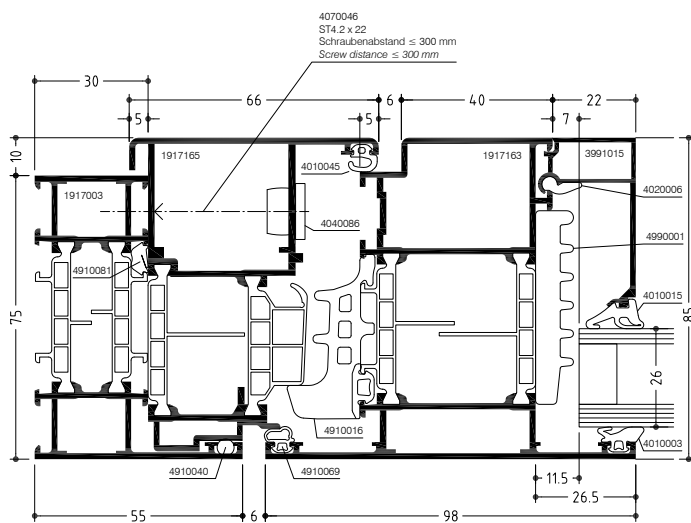

WICLINE 75

Spezial-Dämmprofil - Klapp - Fenster
Special insulation profile - Top-hung window

Wärmedämmung
Thermal insulation

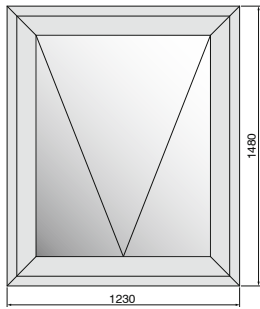

Ansichts- breite System width [mm]	Blendrahmen <i>Frame</i>		Flügel <i>Sash</i>		2-fach Glas <i>Double glazing</i>			3-fach Glas <i>Triple glazing</i>		
	Nr. No.	Breite Width [mm]	Nr. No.	Breite Width [mm]	$U_f -$ [W/(m²K)]	$U_w -$ [W/(m²K)] $U_g = 1,1$ $U_g = 0,9$		$U_f -$ [W/(m²K)]	$U_w -$ [W/(m²K)] $U_g = 0,7$ $U_g = 0,5$	
133	1917093	29	1917163	98	1,5	1,4	1,2	1,4	1,1	0,94

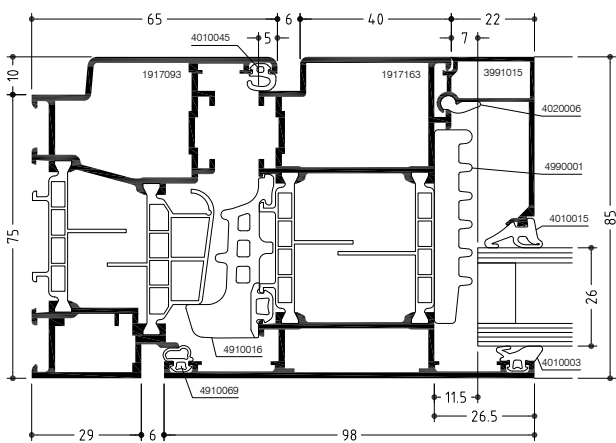

WICLINE 75

Hochwärmedämmend - Festverglasung
High insulated - Fixed glazing

Wärmedämmung
Thermal insulation

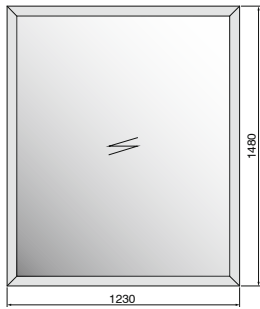

Ansichts- breite System width [mm]	Blendrahmen <i>Frame</i>		2-fach Glas <i>Double glazing</i>			3-fach Glas <i>Triple glazing</i>		
	Nr. No.	Breite Width [mm]	$U_f -$ [W/(m ² K)]	$U_w -$ [W/(m ² K)] $U_g = 1,1$ $U_g = 0,9$		$U_f -$ [W/(m ² K)]	$U_w -$ [W/(m ² K)] $U_g = 0,7$ $U_g = 0,5$	
75	1910148	75	1,2	1,3	1,1	1,1	0,89	0,72

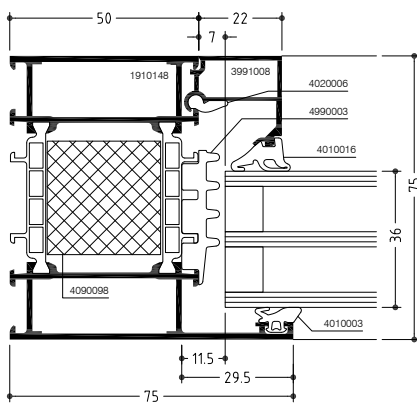

WICLINE 75

Hochwärmedämmend - Drehkipp-Fenster
High insulated - Turn/tilt window

Wärmedämmung
Thermal insulation

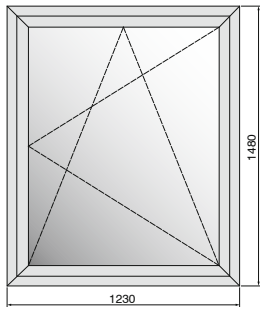

Ansichts- breite System width [mm]	Blendrahmen <i>Frame</i>		Flügel <i>Sash</i>		2-fach Glas <i>Double glazing</i>			3-fach Glas <i>Triple glazing</i>		
	Nr. No.	Breite Width [mm]	Nr. No.	Breite Width [mm]	U_i - [W/(m ² K)]	U_w - [W/(m ² K)] $U_g = 1,1$ $U_g = 0,9$		U_i - [W/(m ² K)]	U_w - [W/(m ² K)] $U_g = 0,7$ $U_g = 0,5$	
132	1910148	75	1910146	51	1,4	1,3	1,2	1,3	1,0	0,90
142	1910148	75	1910147	61	1,3	1,3	1,1	1,2	1,0	0,88

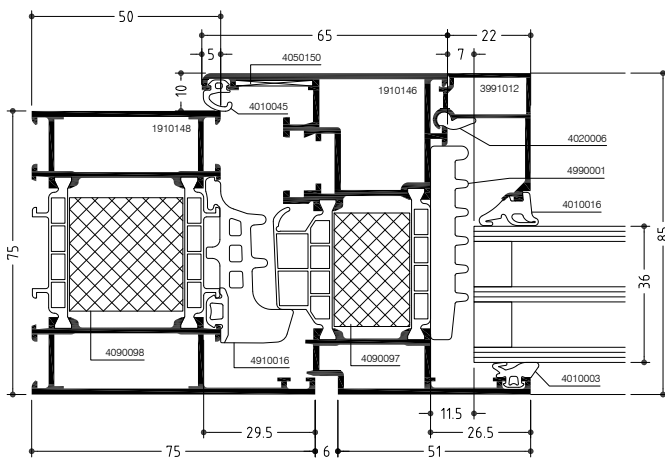

WICLINE 75

Hochwärmedämmend - Drehkipp - Fenster mit Festverglasung
High insulated - Turn/tilt window with fixed glazing

Wärmedämmung
Thermal insulation

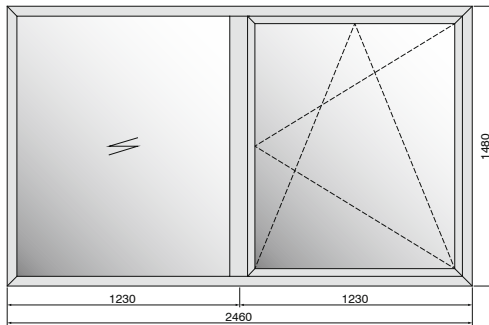

Ansichts- breite System width [mm]	Kämpfer <i>Transom</i>		Flügel <i>Sash</i>		Rahmen Nr. <i>Frame No.</i>	2-fach Glas <i>Double glazing</i>					3-fach Glas <i>Triple glazing</i>				
	Nr. <i>No.</i>	Breite <i>Width</i> [mm]	Nr. <i>No.</i>	Breite <i>Width</i> [mm]		U_t Kämpfer U_t <i>transom</i>	U_t Festfeld U_t <i>fixed</i>	U_t Flügel U_t <i>sash</i>	$U_w - [W/(m^2K)]$		U_t Kämpfer U_t <i>transom</i>	U_t Festfeld U_t <i>fixed</i>	U_t Flügel U_t <i>sash</i>	$U_w - [W/(m^2K)]$	
									$U_g = 1,1$	$U_g = 0,9$				$U_g = 0,7$	$U_g = 0,5$
157	1910149	100	1910146	51	1910148	1,4	1,2	1,4	1,3	1,1	1,3	1,1	1,3	0,95	0,78
167	1910149	100	1910147	61	1910148	1,4	1,2	1,3	1,3	1,1	1,3	1,1	1,2	0,94	0,78

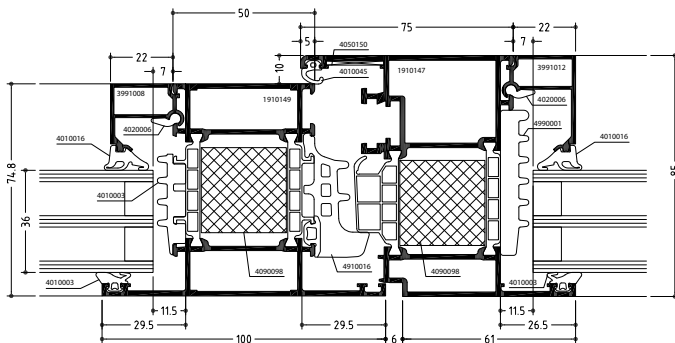

» Schallschutz

Sound insulation



Schallschutz
Sound insulation

Serie System	Fenster Window		Maßnahmen Measures	Verglasung Schallschutz Sound reduction glazing	
	beurteiltes Schalldämmmaß Rw rated sound reduction index Rw (C; Ctr)	bewertetes Schalldämmmaß RwR weighted sound reduction index RwR (DIN 4109:11/1989)		Aufbau Set-up	Schalldämmwert Rw sound reduction index Rw DIN EN 20140
WL 65 / 75	39 (-2; -4) dB ¹	37 dB		Fl 10mm SZR 16mm Fl 6mm	40 dB
WL 65 / 75	45 (-2; -4) dB ²	43 dB		FL 10mm SZR 24mm VSG 8mm	47 dB
WL 65 / 75	45 (-1; -4) dB ³	43 dB		VSG 17mm SZR 15mm VSG 13mm	51 dB
WL 65 / 75	47 (-1; -4) dB ⁴	45 dB	mit zusätzlicher Aussendichtung with add. gasket	VSG 17mm SZR 15mm VSG 13mm	51 dB
WL 65 / 75	45 (-1; -5) dB ⁵	43 dB	Fenster mit verdecktem Flügel concealed sash	VSG 12mm SZR 12mm VSG 8mm	47 dB
WL 65 / 75	39 (-2; -5) dB ⁶	37 dB	Fenster mit verdecktem Flügel concealed sash	Fl 10mm SZR 16mm Fl 6mm	40 dB
WL 65 / 75	43 (-2; -5) dB ⁷	41 dB	Fenster mit verdecktem Flügel concealed sash	VSG 8mm SZR 16mm Fl 8mm	43 dB

¹ ift 161 37278/2.3 R1 ² ift 161 37278/2.4 R1 ³ ift 161 37278/2.0 R1 ⁴ ift 161 37278/2.2 R1 ⁵ ift 161 37278/1.0 R1

⁶ ift 161 37278/1.1 R1 ⁷ ift 161 37278/1.2 R1

WL 65 ift GAS 175 37278/3 R1

WL 75 ift GAS 175 37278/4

WICLINE 125

Schallschutz
Sound insulation

Sicherheit
Safety

Serie System	Fenster Window			Verglasung Schallschutz Sound reduction glaszing
	beurteiltes Schalldämmmaß Rw rated sound reduction index Rw (C; Ctr)	bewertetes Schalldämmmaß RwR weighted sound reduction index RwR (DIN 4109:11/1989)	Maßnahmen Measures	Aufbau Set-up
WL 125	44 (-2; -5) dB	42 dB		
WL 125	46 (-1; -4) dB	46 dB		
WL 125	47 (-1; -4) dB	45 dB		
WL 125	47 (-2; -4) dB	45 dB		
WL 125	44 (-1; -5) dB	42 dB		
WL 125	47 (-2; -6) dB	45 dB		
WL 125	48 (-2; -5) dB	46 dB		

WICLINE 125 ift 161 25694/1.5.0

WICLINE 125 ift 161 25694/1.2.0

WICLINE 125 ift 161 25694/1.4.0

WICLINE 125 ift 161 25694/1.1.0

WICLINE 125 ift 161 26019/1.2.0

WICLINE 125 ift 161 26019/1.1.0

WICLINE 125 ift 161 26019/1.0.0

3

WICLINE 215

Schallschutz
Sound insulation

Sicherheit
Safety





Serie System	Fenster Window			Verglasung Schallschutz Sound reduction glazing
	beurteiltes Schalldämmmaß R_w <i>rated sound reduction index R_w</i> (C; Ctr)	bewertetes Schalldämmmaß R_wR <i>weighted sound reduction index R_wR</i> (DIN 4109:11/1989)	Maßnahmen <i>Measures</i>	Aufbau <i>Set-up</i>
WL 215	55 (-1; -5) dB	53 dB		ESG 8mm 118mm VSG SI 8,5mm SZR 16mm FI 10mm

» Sicherheit

Safety

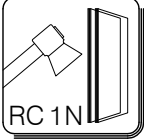

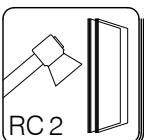
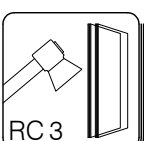
Symbole
Symbols

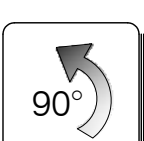
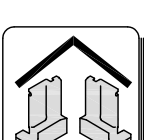
Symbol	Bezeichnung	Symbol	Bezeichnung
<i>Symbols</i>	<i>Designation</i>	<i>Symbols</i>	<i>Designation</i>
	Einbruchhemmung RC 1 N nach DIN EN 1627:2011 <i>Burglary resistance class RC 1 N according to DIN EN 1627:2011</i>		
	Einbruchhemmung RC 2 N nach DIN EN 1627:2011 <i>Burglary resistance class RC 2 N according to DIN EN 1627:2011</i>		
	Einbruchhemmung RC 2 nach DIN EN 1627:2011 <i>Burglary resistance class RC 2 according to DIN EN 1627:2011</i>		
	Einbruchhemmung RC 3 nach DIN EN 1627:2011 <i>Burglary resistance class RC 3 according to DIN EN 1627:2011</i>		
	Durchschusshemmung nach EN 1522 <i>Bullet resistance according to EN 1522</i>		
	Darstellung 90° gedreht <i>Representation turned by 90°</i>		
	Garnitur Set		

Übersicht EH-Komponenten
Survey of burglar resistant components

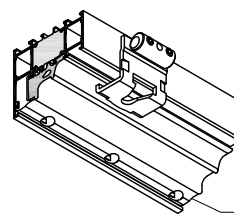
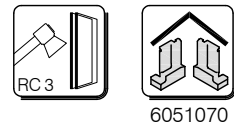
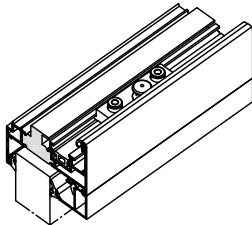
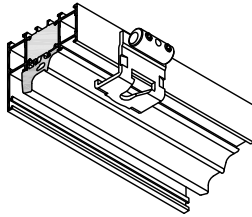
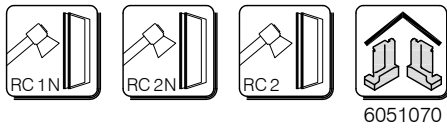
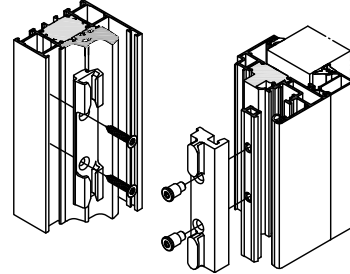
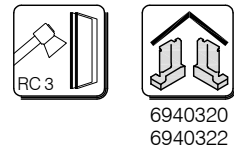
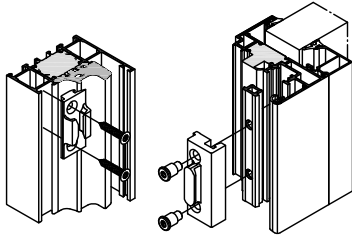
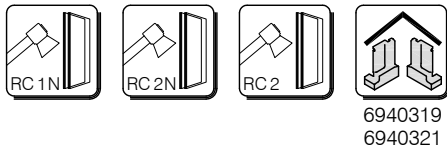

6940334

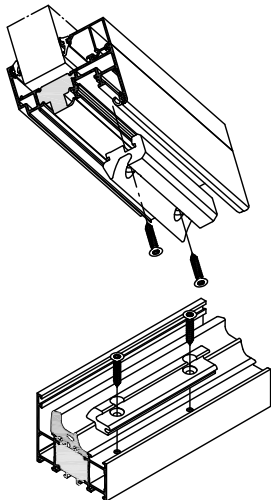
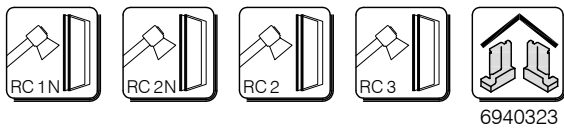

Übersicht EH-Komponenten
Survey of burglar resistant components

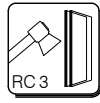

6940325

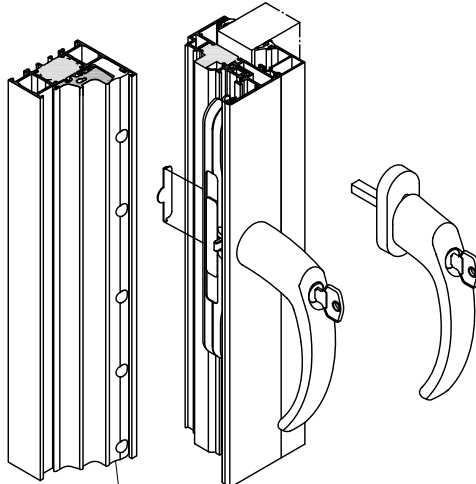
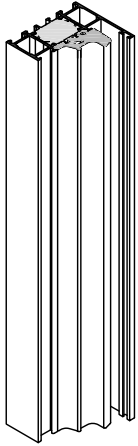
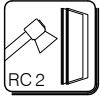

6940334

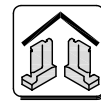
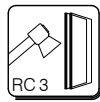
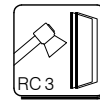
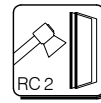
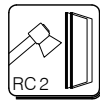

6940334

6940326

6940334

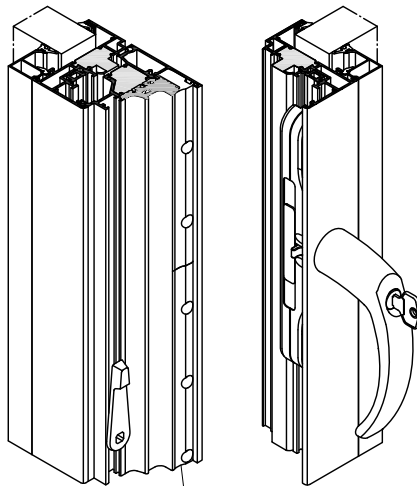
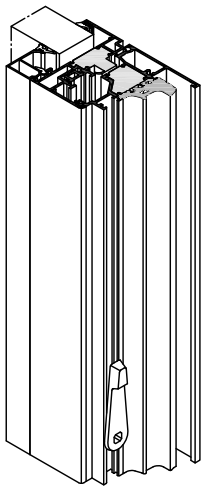

2 x 6940334

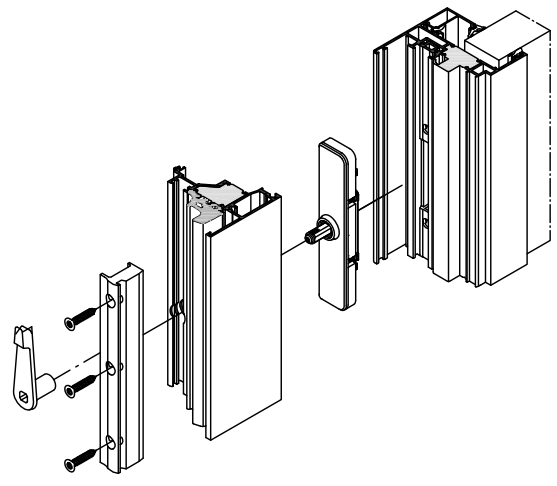

System System	Prüfinstitut Test institute	Prüfbericht Test report	Verglasung nach Glazing acc. to DIN EN 1627:2011	Paneel nach Panel acc. to EN 356	Prüfklasse test class	Bemerkung remarks
WICLINE 65/75	ift Rosenheim	11-001211-PR01	ohne Anforderung <i>without requirements</i>	P4A	WK1 / RC1	max. Flügelbreite 1700 mm, max. Flügelhöhe 2500mm (Oberlicht max. Flügelbreite 2500 mm, max. Flügelhöhe 1700mm) <i>max. sash width 1700 mm, max. sash height 2500mm (fanlight max. sash width 2500 mm, max. sash height 1700mm)</i>
WICLINE 65/75	ift Rosenheim	11-001211-PR02	P4A	P4A	WK2 / RC2	max. Flügelbreite 1700 mm, max. Flügelhöhe 2500mm (Oberlicht max. Flügelbreite 2500 mm, max. Flügelhöhe 1700mm) <i>max. sash width 1700 mm, max. sash height 2500mm (fanlight max. sash width 2500 mm, max. sash height 1700mm)</i>
WICLINE 65/75	ift Rosenheim	11-001211-PR03	P6B	P7B / P8B	WK3 / RC3	max. Flügelbreite 1700 mm, max. Flügelhöhe 2500mm (Oberlicht max. Flügelbreite 2500 mm, max. Flügelhöhe 1700mm) <i>max. sash width 1700 mm, max. sash height 2500mm (fanlight max. sash width 2500 mm, max. sash height 1700mm)</i>
						zulässiges Flügelgewicht beachten <i>respect max. sash weight</i>

WICLINE 65

Konstruktionsschnitt

Construction section

Flügelprofil im Blendrahmen mit Kämpfer

EH-Verriegelung / Füllungssicherung

Sash profile in frame with transom

Burglar resistant locking / Infill safeguard

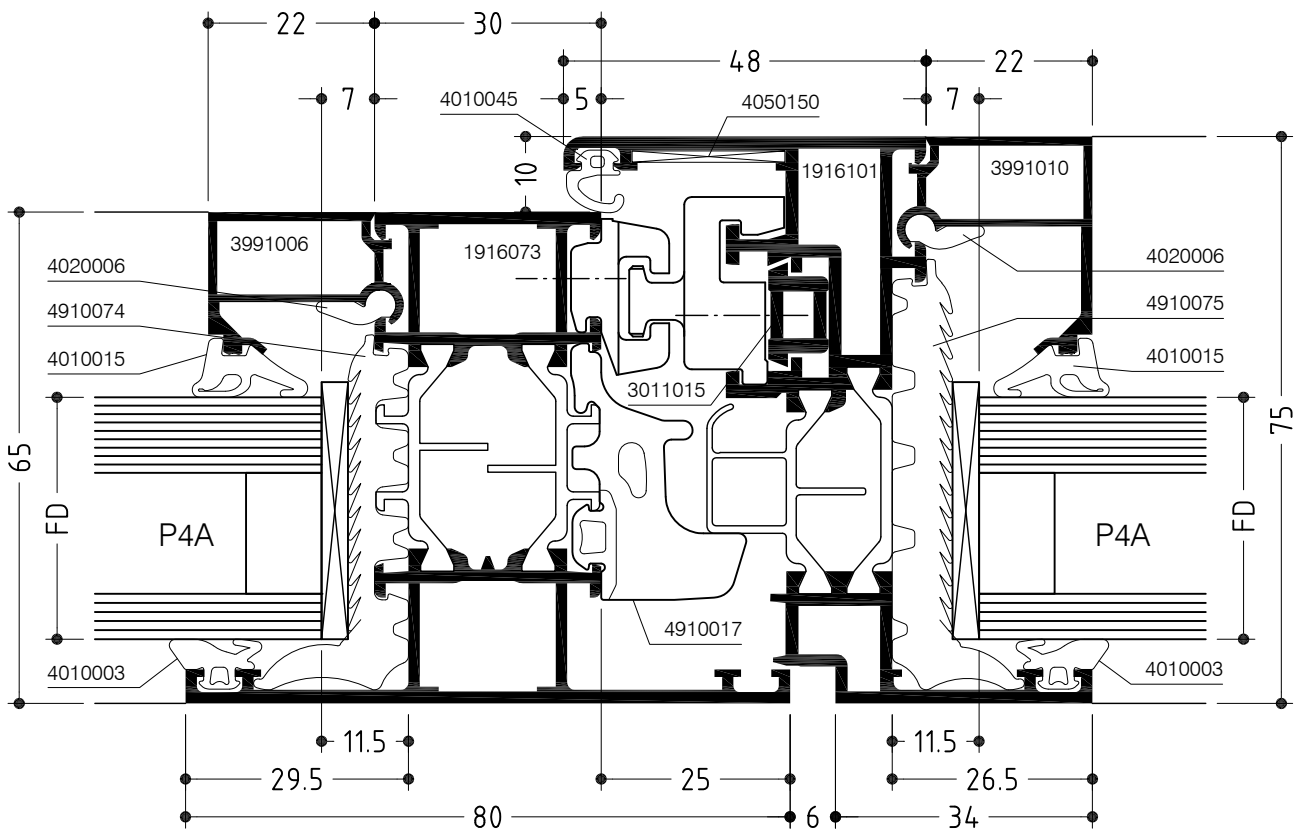
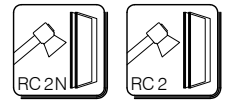
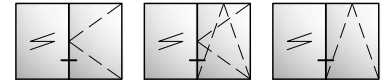

WICLINE 65

Konstruktionsschnitt

Construction section

Flügelprofil im Blendrahmen mit Kämpfer

EH-Verriegelung / Füllungssicherung

Sash profile in frame with transom

Burglar resistant locking / Infill safeguard

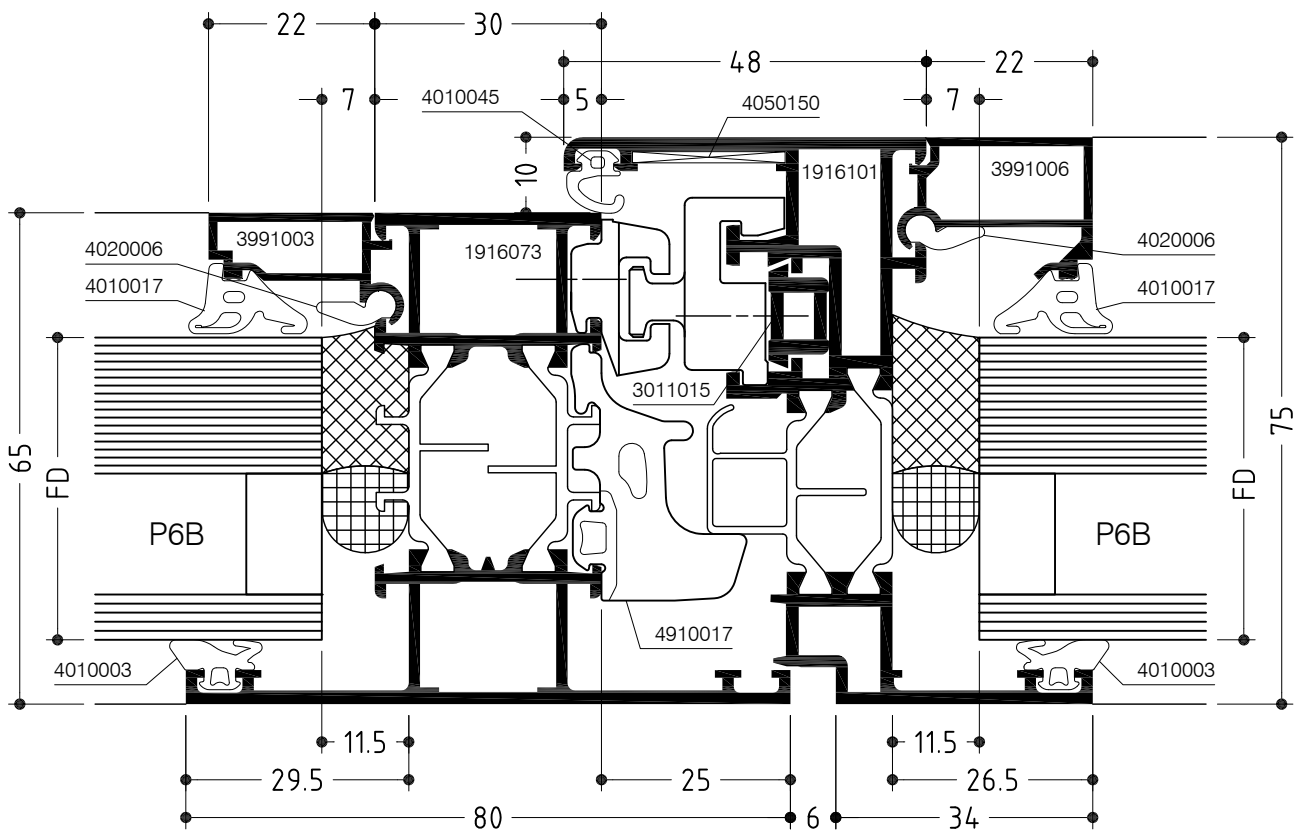
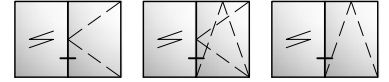

4

WICLINE 65

Konstruktionsschnitt

Construction section

Stulpfenster mit Aufsatzprofil - Mittelstoß

EH-Verriegelung / Füllungssicherung

Double casement window with supplm. profile - Meeting stiles

Burglar resistant locking / Infill safeguard

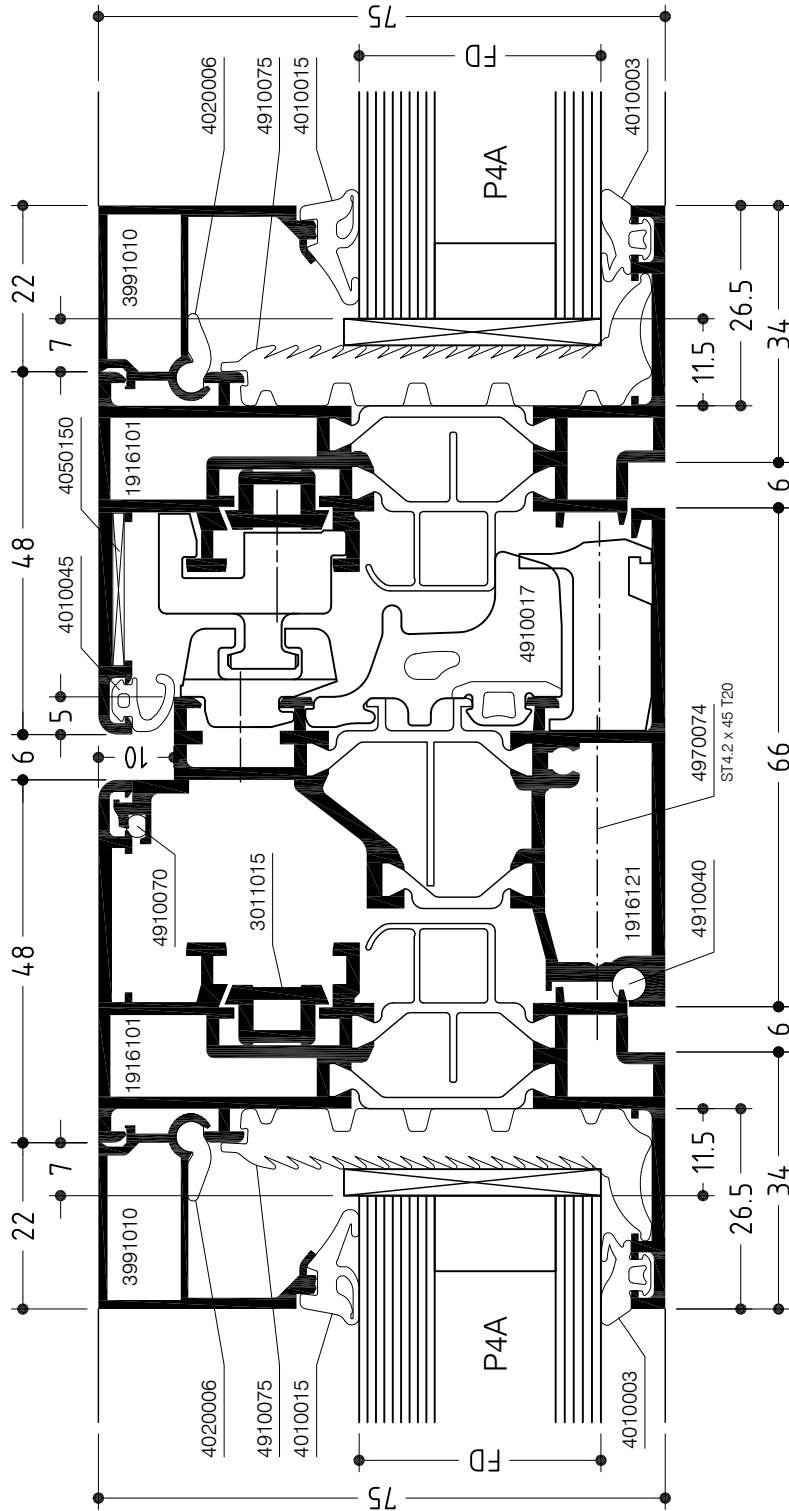
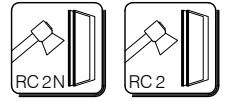
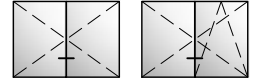

WICLINE 65

Konstruktionsschnitt Construction section

Stulpfenster mit Aufsatzprofil - Mittelstoß
 EH-Verriegelung / Füllungssicherung
 Double casement window with supplm. profile - Meeting stiles
 Burglar resistant locking / Infill safeguard

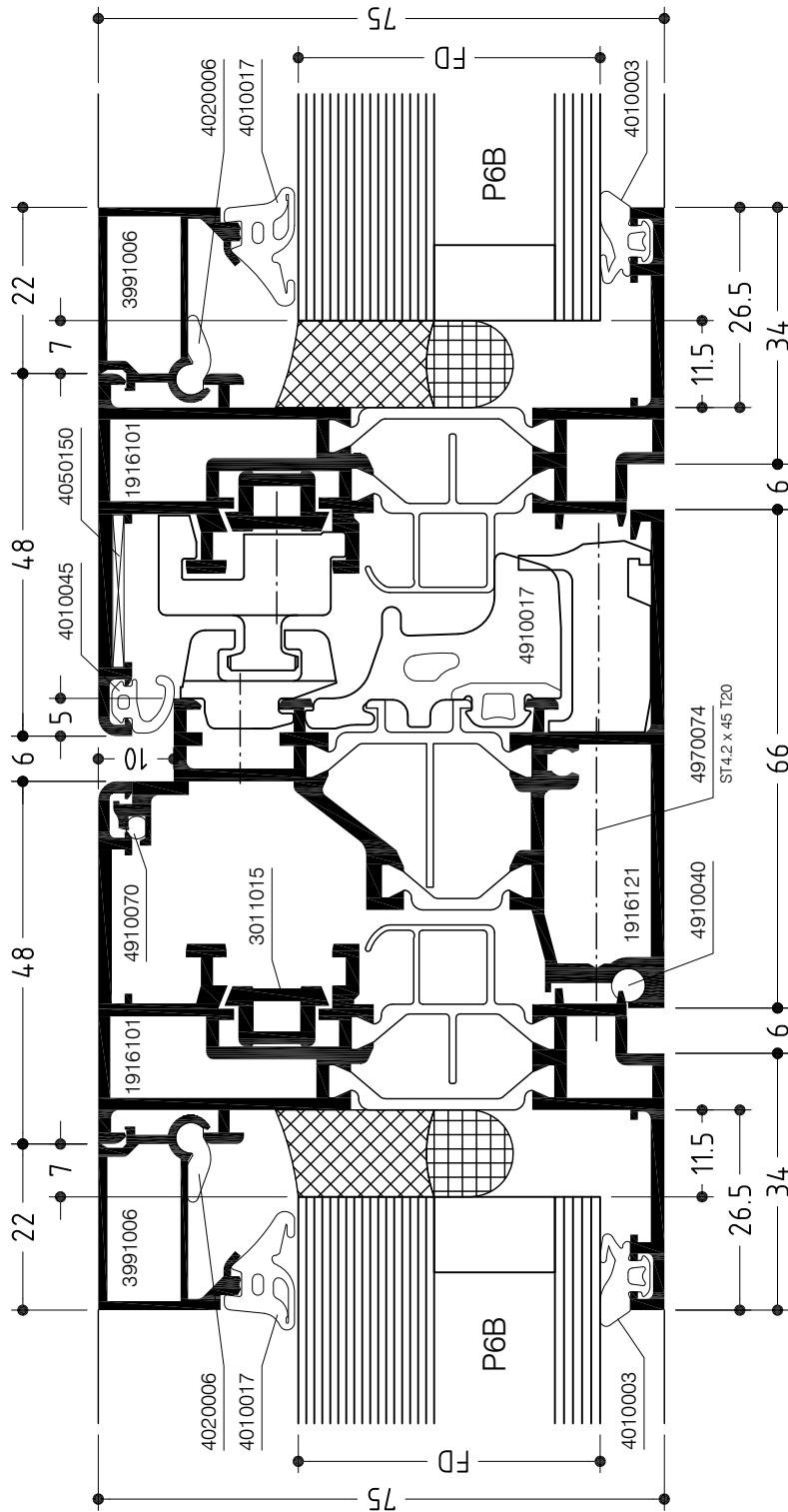
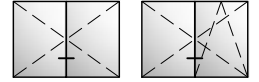

WICLINE 65

Konstruktionsschnitt

Construction section

Flügelprofil im Blendrahmen mit Kämpfer, Klassik-Design

EH-Verriegelung / Füllungssicherung

Sash profile in frame with transom, Classic design

Burglar resistant locking / Infill safeguard

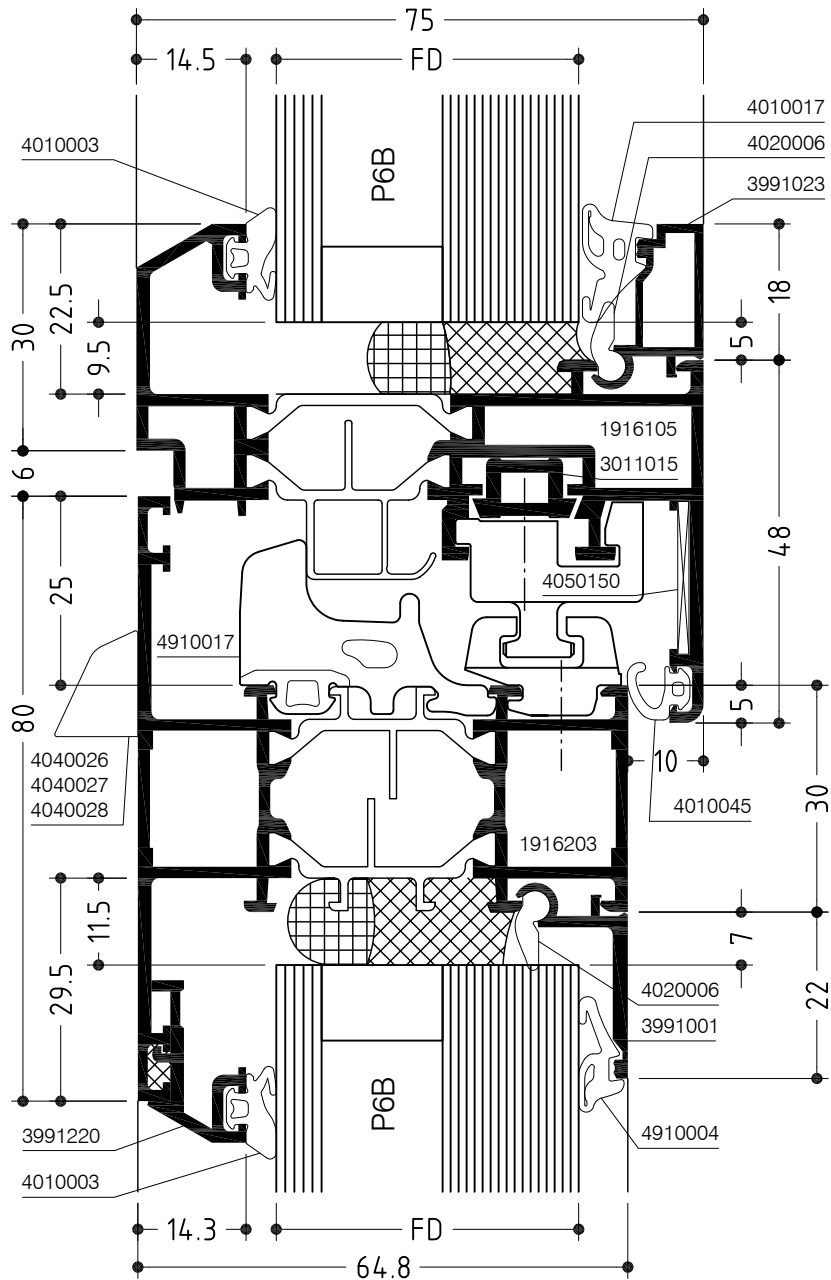
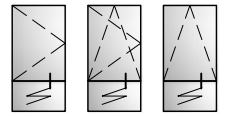

WICLINE 65

Konstruktionsschnitt

Construction section

Flügelprofil im Blendrahmen mit Kämpfer, verdeckter Flügel

EH-Verriegelung / Füllungssicherung

Concealed sash in frame with transom

Burglar resistant locking / Infill safeguard

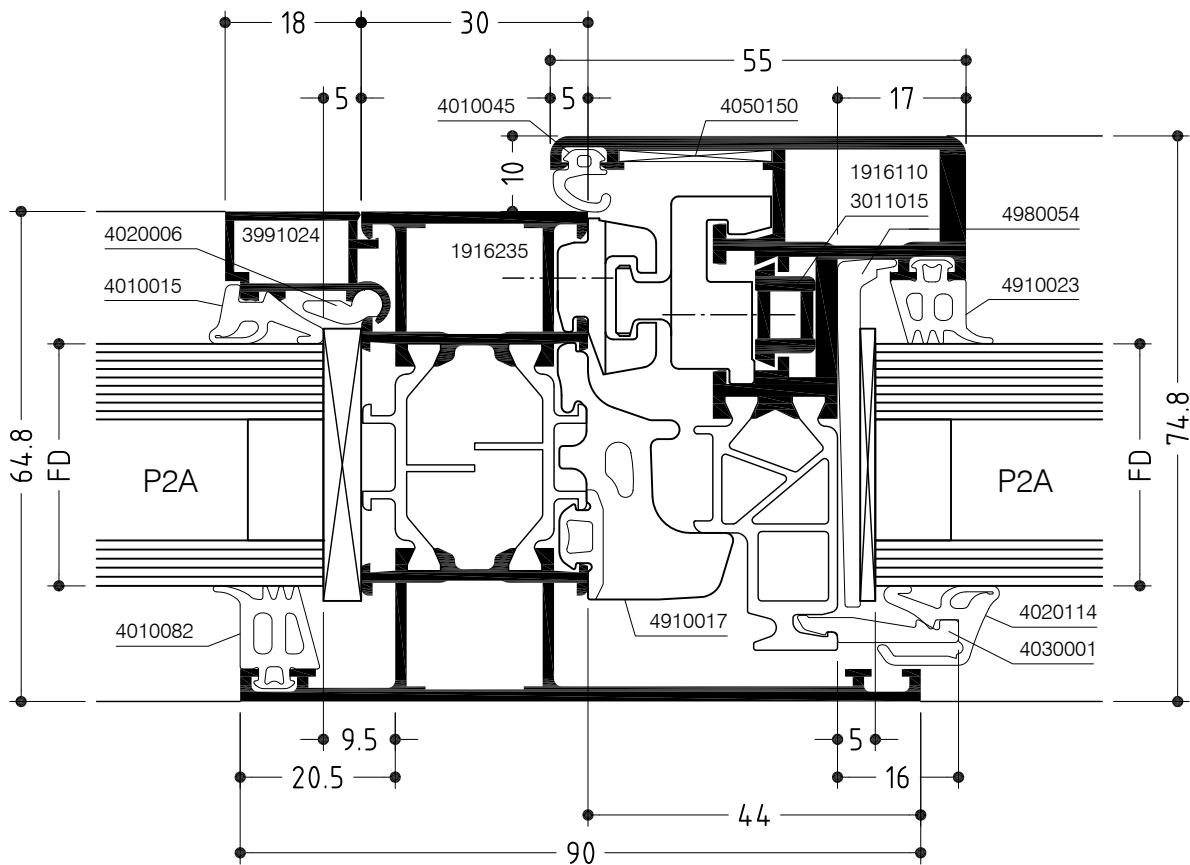
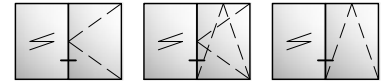

WICLINE 65

Konstruktionsschnitt

Construction section

Flügelprofil im Blendrahmen mit Kämpfer, verdeckter Flügel

EH-Verriegelung / Füllungssicherung

Concealed sash in frame with transom

Burglar resistant locking / Infill safeguard

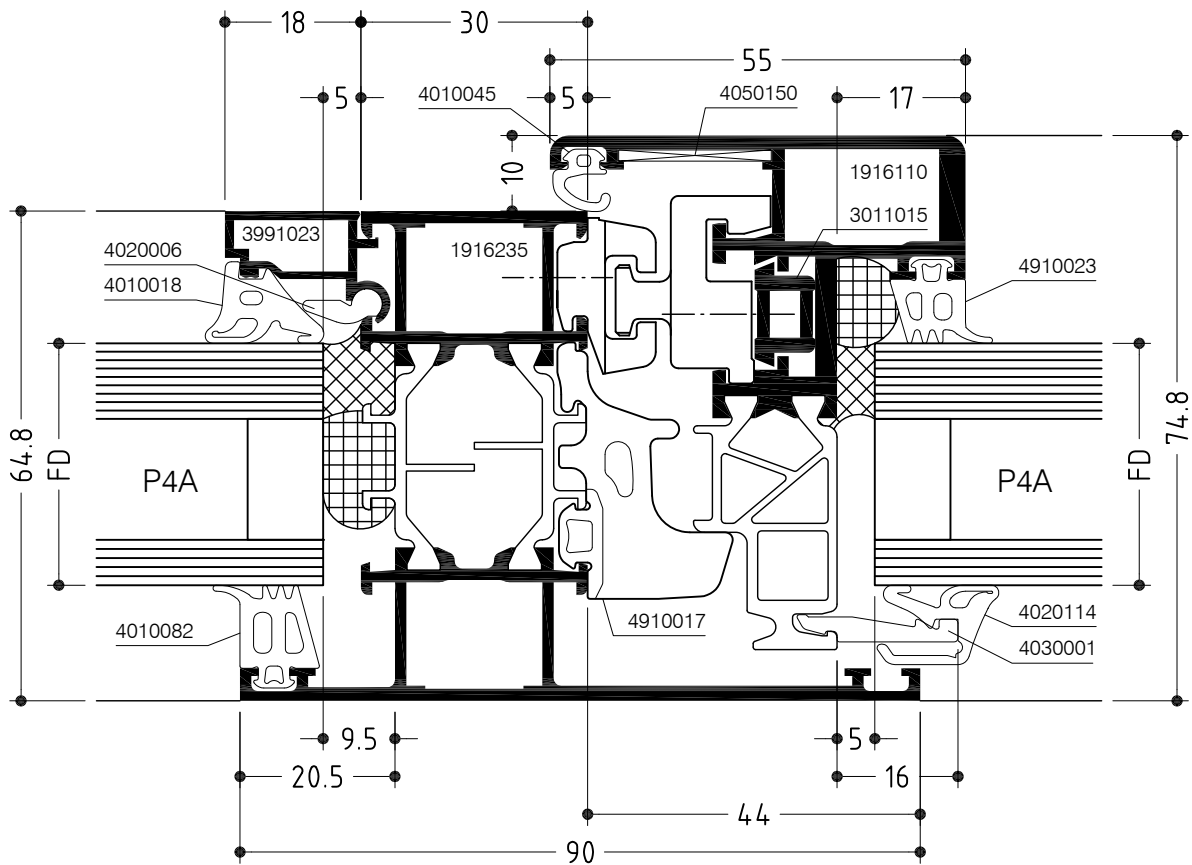
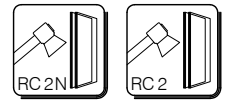
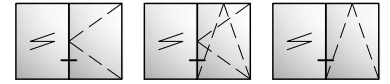

WICLINE 65

Konstruktionsschnitt

Construction section

Flügelprofil im Blendrahmen mit Kämpfer, verdeckter Flügel

EH-Verriegelung / Füllungssicherung

Concealed sash in frame with transom

Burglar resistant locking / Infill safeguard

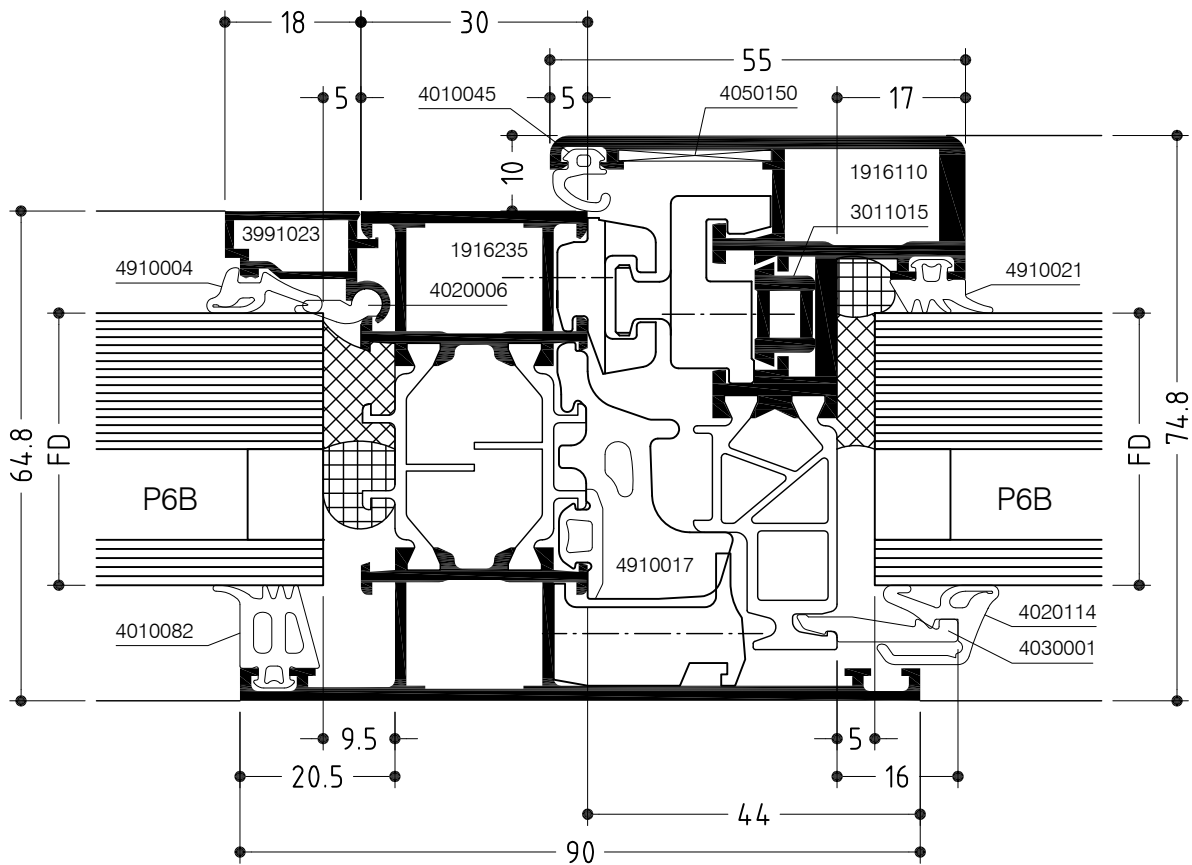
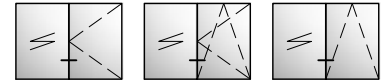

WICLINE 75

Flügelprofil im Blendrahmen mit Kämpfer
EH-Verriegelung / Füllungssicherung

Sash profile in frame with transom

Burglar resistant locking / Infill safeguard

Konstruktionsschnitt

Construction section

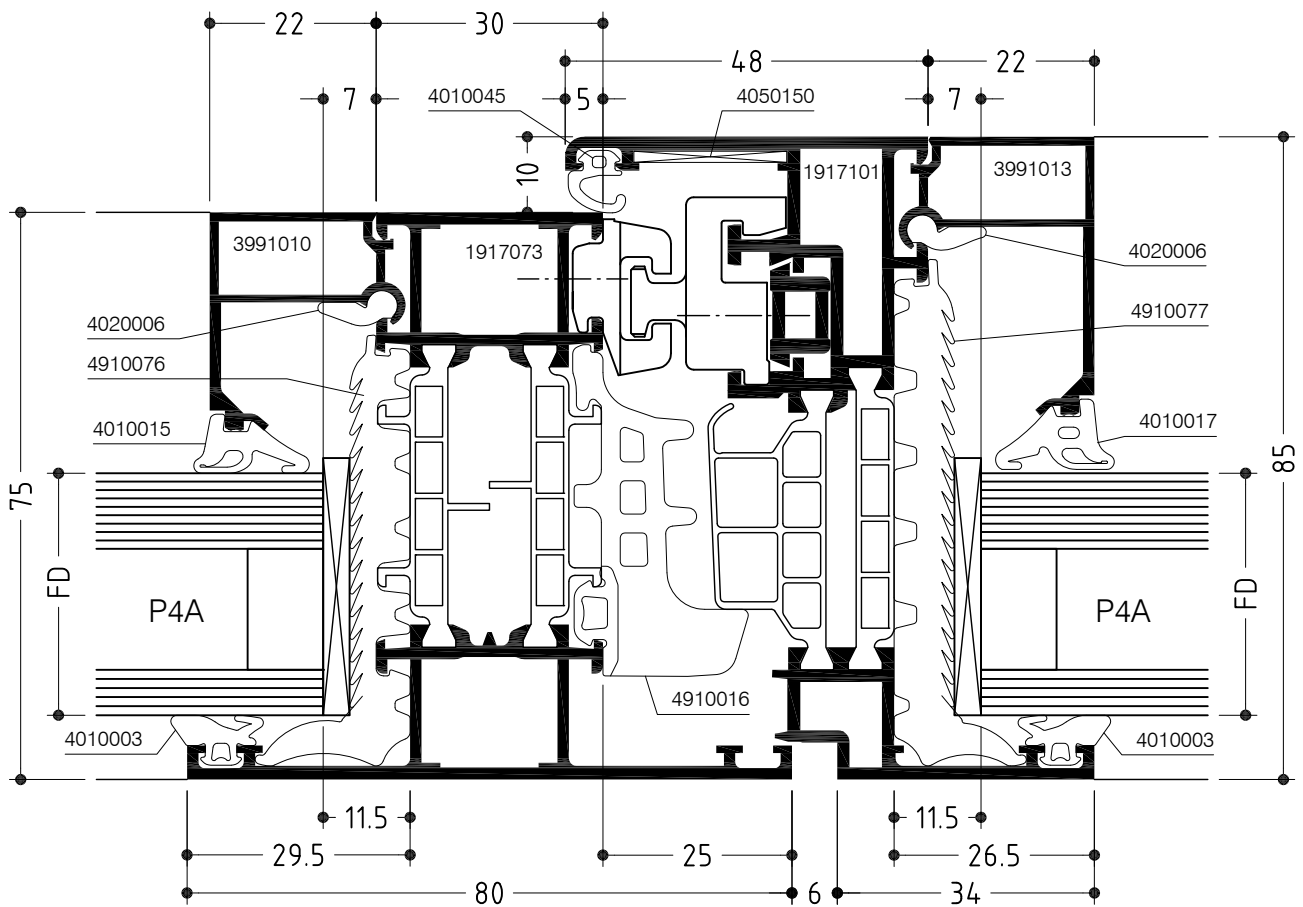
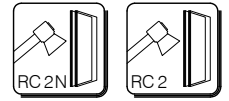
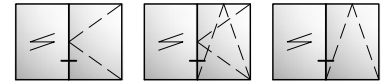

WICLINE 75

Konstruktionsschnitt

Construction section

Flügelprofil im Blendrahmen mit Kämpfer

EH-Verriegelung / Füllungssicherung

Sash profile in frame with transom

Burglar resistant locking / Infill safeguard

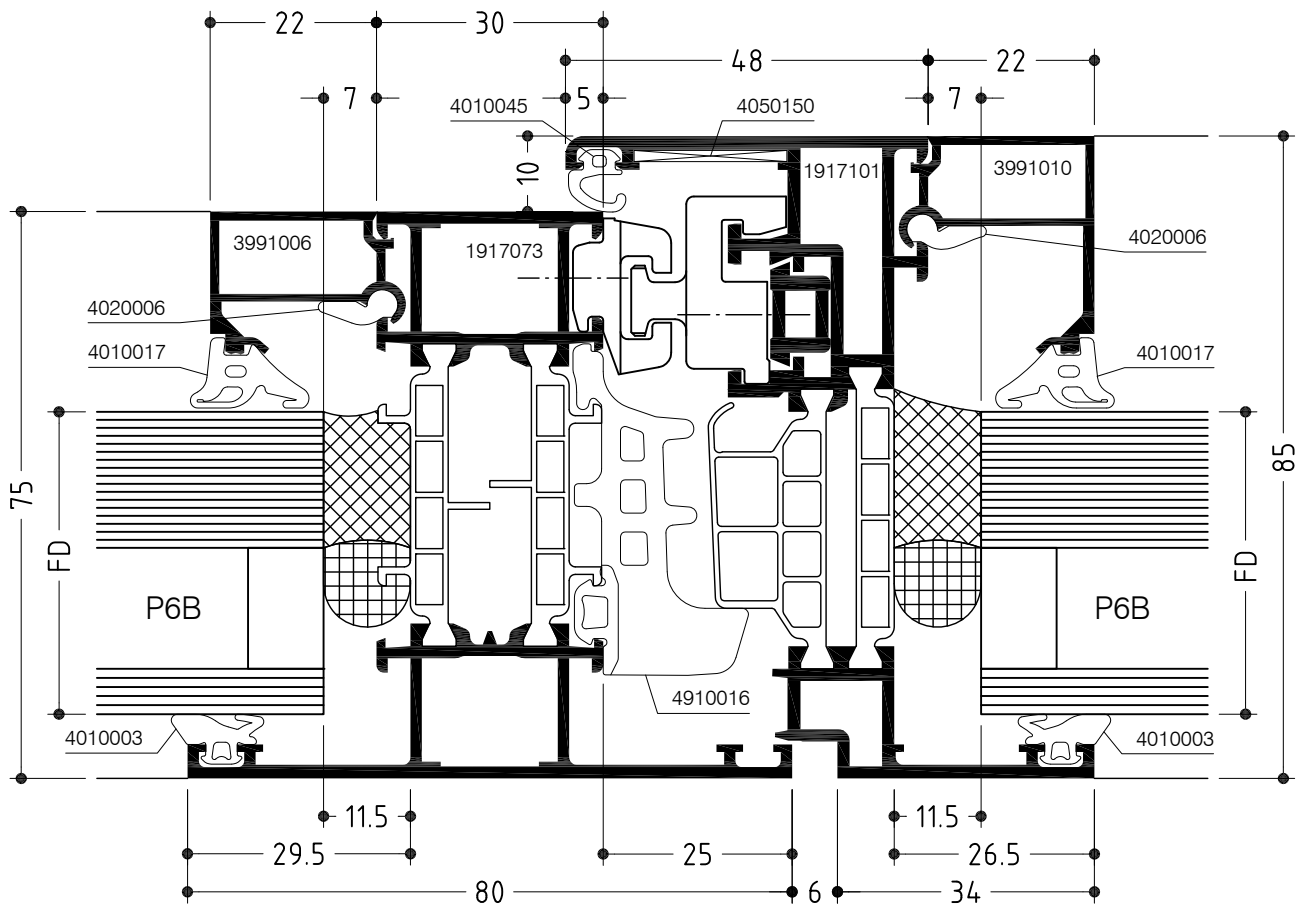
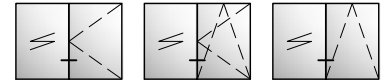

4

WICLINE 75

Konstruktionsschnitt Construction section

Stulpfenster mit Aufsatzprofil - Mittelstoß
 EH-Verriegelung / Füllungssicherung
 Double casement window with supplm. profile - Meeting stiles
 Burglar resistant locking/ Infill safeguard

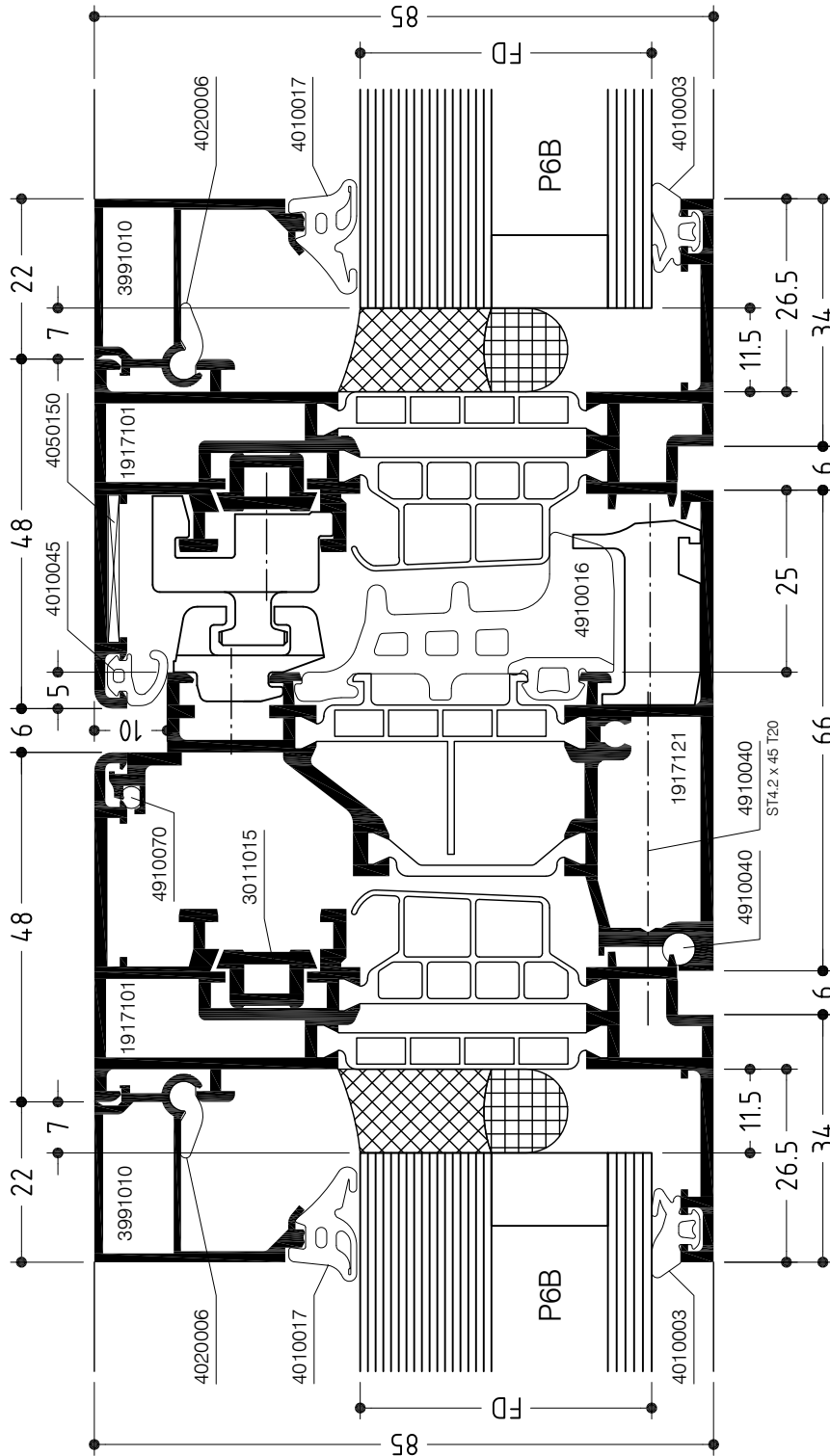
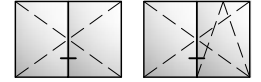

WICLINE 75

Konstruktionsschnitt

Construction section

Flügelprofil im Blendrahmen mit Kämpfer, Klassik-Design

EH-Verriegelung / Füllungssicherung

Sash profile in frame with transom, Classic design

Burglar resistant locking / Infill safeguard

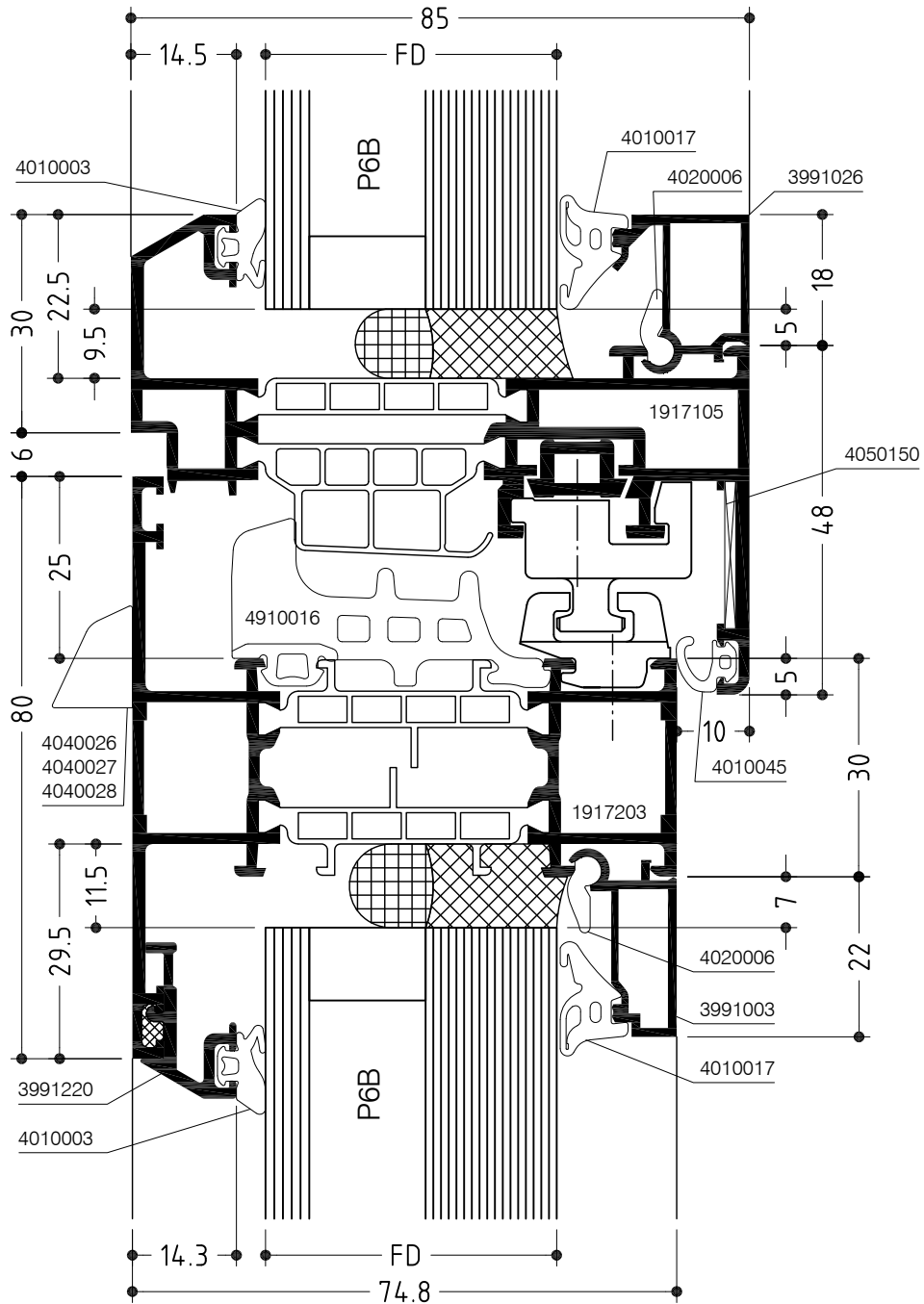
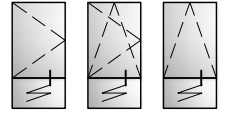

WICLINE 75

Konstruktionsschnitt

Construction section

Flügelprofil im Blendrahmen mit Kämpfer, verdeckter Flügel

EH-Verriegelung / Füllungssicherung

Concealed sash in frame with transom

Burglar resistant locking / Infill safeguard

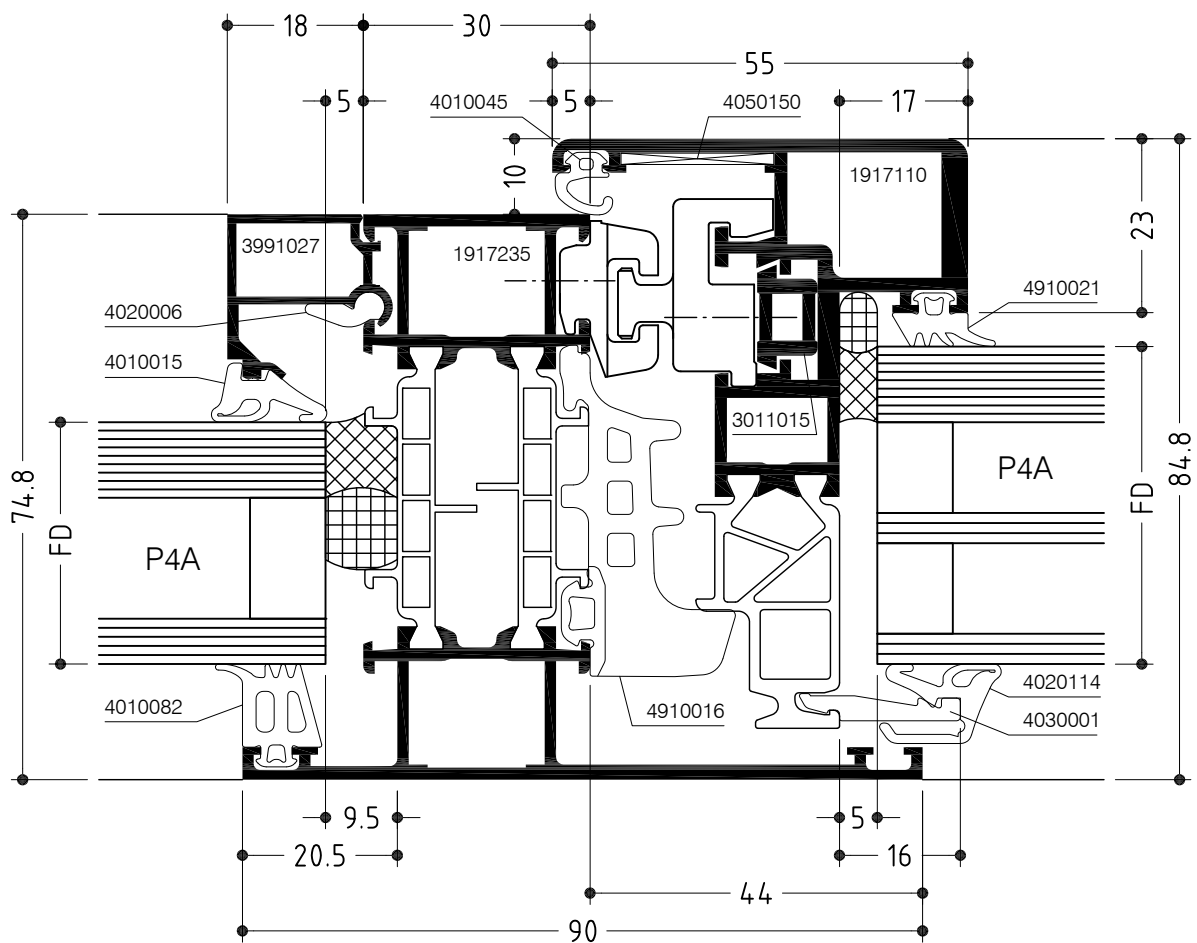
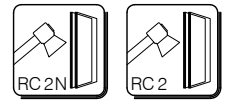
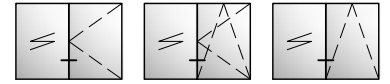

WICLINE 75

Konstruktionsschnitt

Construction section

Flügelprofil im Blendrahmen mit Kämpfer, verdeckter Flügel

EH-Verriegelung / Füllungssicherung

Concealed sash in frame with transom

Burglar resistant locking / Infill safeguard

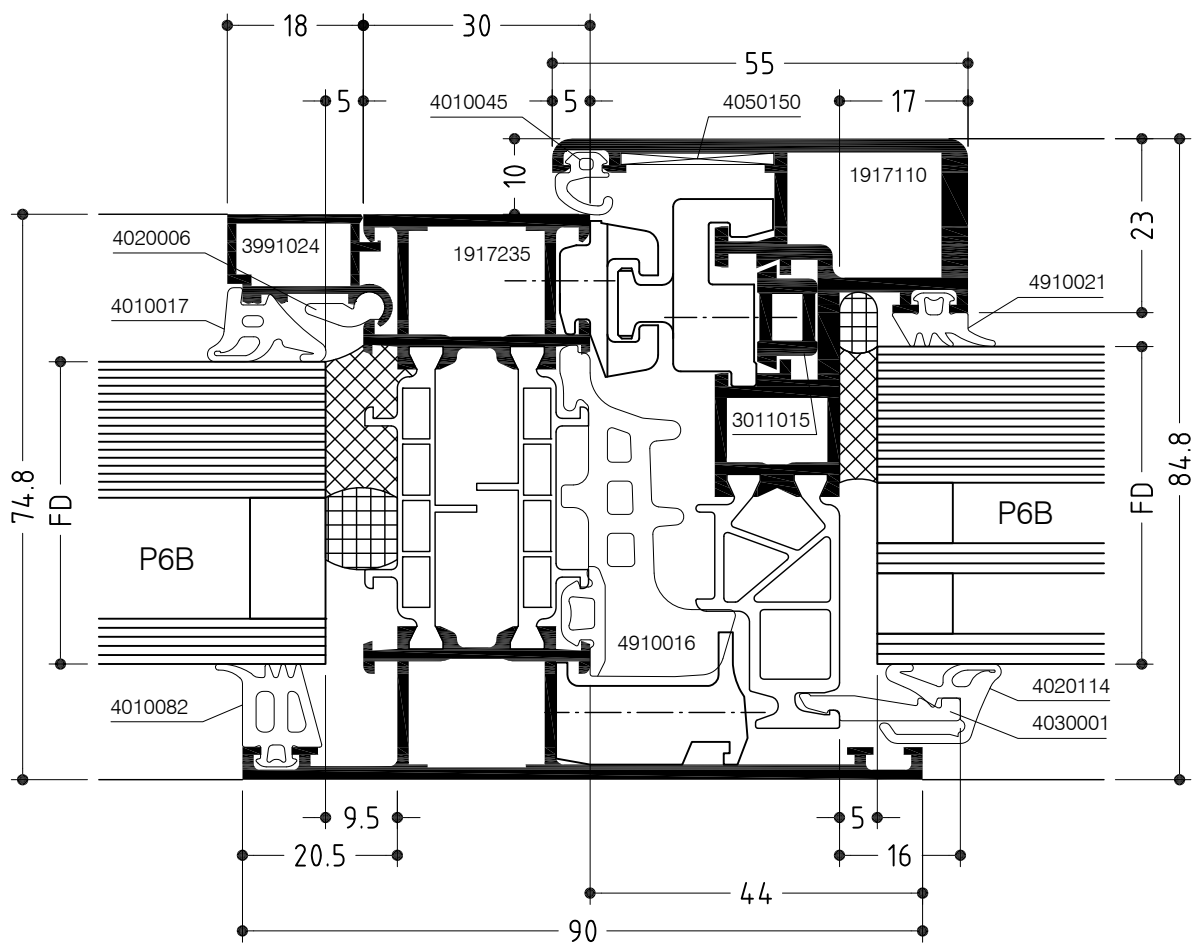
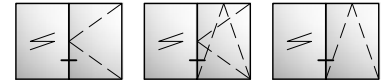

Fenster / Türen, durchschusshemmend nach DIN EN 1522
Windows / doors, bullet resistant according to DIN EN 1522

Allgemeines:

Als Ergänzung zum Systemprogramm wurden die Serien WICLINE 65/75 in der durchschusshemmenden Widerstandsklasse bis FB 4 nach der aktuell gültigen europäischen Norm DIN EN 1522 geprüft.

Normen:

- DIN EN 1522
Fenster, Türen, Abschlüsse
Durchschusshemmung
Klassifizierung und Anforderungen
- DIN EN 1523
Fenster, Türen, Abschlüsse
Durchschusshemmung
Prüfverfahren
- DIN EN 1063
Sicherheitssonderverglasungen
Prüfverfahren und Klasseneinteilung für den Widerstand gegen Beschuss.

Hinweis:

Der Begriff "durchschusshemmende Verglasung" bezieht sich auf Erzeugnisse, die die eindeutigen Eigenschaften von Glas haben und die ein Verbund aus Glas und Kunststoff sind.

General:

In addition to the system program the series WICLINE 65/75 have been tested according to the current European standard DIN EN 1522 in the bullet resistance class up to FB 4.

Standards:

- DIN EN 1522
*Windows, doors, closures
Bullet resistance
Classification and requirements*
- DIN EN 1523
*Windows, doors, closures
Bullet resistance
Testing procedures*
- DIN EN 1063
*Special safety glazings
Testing methods and classifications for the resistance against bullet attack.*

Note:

The term "bullet resistant glazing" refers to products with the distinct properties of glass and which are a compound of glass and plastic.

Übersicht der einzelnen Widerstandsklassen und Zuordnung der Gläser:

Overview of the several classes of resistance and classification of the glasses:

Beschussklasse nach EN 1522 <i>Bullet resistant class according EN 1522</i>	Zertifizierte Gläser, geprüft nach DIN EN 1063 <i>Certified glazing, tested according DIN EN 1063</i>
FB 1	BR 1
FB 2	BR 2
FB 3	BR 3
FB 4	BR 4

Hinweise:

- Es dürfen nur die im Profilsystem geprüften und von den Glasherstellern zertifizierten Glástypen mit Nachweis eingesetzt werden.
- Unzulässig sind Veränderungen im Glasaufbau, Scheibenzwischenraum und Einbaudicke.
- Die mit Etikett gekennzeichnete Angriffsseite der Verglasung muss mit der definierten Angriffsseite des Profilsystems übereinstimmen.
- Gläser wahlweise mit zusätzlicher Kennzeichnung in Ausführung "NS" (kein Splitterabgang) oder in Ausführung "S" (mit Splitterabgang).

Notes:

- *Only glass types which have been certified by the glass manufacturer with approval proof for the profile system may be used.*
- *Modifications to the glass design, glass interspace and infill Thickness are not allowed.*
- *The labelled assault side of the glazing must correspond with the assault side of the profile system.*
- *Glazings optionally with additional marking version "NS" (no splinters) or in version "S" (with splinters).*

WICLINE 65 / WICSTYLE 65

Auswahl für durchschusshemmende Verglasung nach DIN EN 1063

Klasse BR 4-NS und BR 4-S im Mono- und Isolierglasaufbau

Selection for bullet resistant glazing according DIN EN 1063

Class BR 4-NS and BR 4-S in single and insulating glazing

Durchschusshemmende Verglasung, Klasse BR 4-NS nach EN 1063 / *Bullet resistant glazing, Class BR 4-NS according EN 1063*
Prüfzertifikat S 11 0032-01 FB 4-NS, Beschussamt Ulm / *Testcertificat S 11 0032-01 FB 4-NS, Department of ballistics Ulm*

Pos. Pos.	Klasse / Class (EN 1063)	Mono/Iso Single/Ins	Masse / Weight (kg/m ²)	Dicke / Thickness (mm)	Bezeichnung / Designation	Hersteller / Manufacturer
1	BR 4-NS	Mono	115	48	Multistop -BR 4-NS-0-48	Glas Trösch GmbH
2	BR 4-NS	Mono	45	24	Novalay secure BR 4-NS / 1.3.1	Schott Technical Glassolution GmbH
3	BR 4-NS	Mono	96	44	Novalay secure BR 4-NS / 1.5.4	Schott Technical Glassolution GmbH
4	BR 4-NS	Iso	93	50	Novalay secure BR 4-NS / 1.6.6	Schott Technical Glassolution GmbH
5	BR 4-NS	Mono	53	25	SILATEC BR 4-NS 25/52	Silatec GmbH

Durchschusshemmende Verglasung, Klasse BR 4-S nach EN 1063 / *Bullet resistant glazing, Class BR 4-S according EN 1063*
Prüfzertifikat S 11 0032-02 FB 4-S, Beschussamt Ulm / *Testcertificat S 11 0032-02 FB 4-S, Department of ballistics Ulm*

Pos. Pos.	Klasse / Class (EN 1063)	Mono/Iso Single/Ins	Masse / Weight (kg/m ²)	Dicke / Thickness (mm)	Bezeichnung / Designation	Hersteller / Manufacturer
6	BR 4-S	Mono	63	36	P8B-17	Flachglas Markenkreis GmbH
7	BR 4-S	Iso	68	36	BR 4-S-21	Flachglas Markenkreis GmbH
8	BR 4-S	Iso	78	50	P8B-27	Flachglas Markenkreis GmbH
9	BR 4-S	Iso	90	50	SGG STADIPT CP-HN 432-S	Saint Gobain GmbH
10	BR 4-S	Iso	67	39	SANCO SAFE BR 4-S-ISO-0-39	Glas Trösch GmbH
11	BR 4-S	Mono	80	33	Multistop -BR4-S-0-33	Glas Trösch GmbH
12	BR 4-S	Iso	72	41	ipasafe BR 4-S Isolierglas	Interpane Sicherheitsglas GmbH & Co
13	BR 4-S	Iso	68	43	Multipact 41 BR 4-S Isolierglas	Glaswerke Arnold GmbH

WICLINE 65 / WICSTYLE 65

Durchschusshemmende, nicht transparente Füllung nach DIN EN 1522

Klasse FB 4-NS

Bullet resistant, opaque infill according DIN EN 1522

Class BR 4-NS

Prüfzertifikat S 11 0032-01 FB 4-NS / Testcertificat S 11 0032-01 FB 4-NS
Prüfzertifikat S 11 0032-02 FB 4-S / Testcertificat S 11 0032-02 FB 4-S
Beschussamt Ulm / Department of ballistics Ulm

Pos. Pos.	Klasse / Class (EN 1522)	Mono/Iso Single/Ins	Masse / Weight (kg/m ²)	Dicke / Thickness (mm)	Bezeichnung / Designation	Hersteller / Manufacturer
14	FB 4-NS	Iso	65	40	Seropal-Paneel	Pohltec GmbH

Hinweis:

Pos.14, durchschusshemmendes, 2-lagiges Paneel mit speziellem Decklagenaufbau auf der Beschussseite aussen.

Note:

Pos.14, bullet resistant double layer panel with special cover sheet compound on the assault side.

WICLINE 75 / WICSTYLE 75

Auswahl für durchschusshemmende Verglasung nach DIN EN 1063

Klasse BR 4-NS und BR 4-S im Mono- und Isolierglasaufbau

Selection for bullet resistant glazing according DIN EN 1063

Class BR 4-NS and BR 4-S in single and insulating glazing

Durchschusshemmende Verglasung, Klasse BR 4-NS nach EN 1063 / *Bullet resistant glazing, Class BR 4-NS according EN 1063*
Prüfzertifikat S 11 0032-03 FB 4-NS, Beschussamt Ulm / *Testcertificat S 11 0032-03 FB 4-NS, Department of ballistics Ulm*

Pos. Pos.	Klasse / Class (EN 1063)	Mono/Iso Single/Ins	Masse / Weight (kg/m ²)	Dicke / Thickness (mm)	Bezeichnung / Designation	Hersteller / Manufacturer
1	BR 4-NS	Mono	112	52	BR 4-NS-21	Flachglas Markenkreis GmbH
2	BR 4-NS	Mono	82	52	SGG STADIPT CP-HN 452-NS	Saint Gobain GmbH
3	BR 4-NS	Mono	110	56	SANCO SAFE BR 4-S-ISO-0-56	Glas Trösch GmbH
4	BR 4-NS	Iso	115	48	Multistop -BR 4-NS-0-48	Glas Trösch GmbH
5	BR 4-NS	Mono	120	57	ipasafe BR 4-S Isolierglas	Interpane Sicherheitsglas GmbH & Co
6	BR 4-NS	Iso	45	24	Novalay secure BR 4 NS / 1.3.1	Schott Technical Glassolution GmbH
7	BR 4-NS	Mono	96	44	Novalay secure BR 4-NS / 1.5.4	Schott Technical Glassolution GmbH
8	BR 4-NS	Iso	93	50	Novalay secure BR 4-NS / 1.6.6	Schott Technical Glassolution GmbH
9	BR 4-NS	Iso	94	60	Novalay secure BR 4-NS / 1.6.5	Schott Technical Glassolution GmbH
10	BR 4-NS	Iso 3-fach Iso triple	100	60	Novalay secure BR 4-NS / 1.6.5	Schott Technical Glassolution GmbH
11	BR 4-NS	Mono	100	57	Multipact 55 BR 4-NS Isolierglas	Glaswerke Arnold GmbH
12	BR 4-NS	Iso	53	25	SILATEC BR 4-NS 25/52	Silatec GmbH

Hinweis:

Pos.10 siehe Prüfzertifikat S 11 0090 01 / Z vom 24.08.2011, BA Ulm

Note:

Pos.10 see Testcertificat S 11 0090 01 / Z vom 24.08.2011, BA Ulm

Durchschusshemmende Verglasung, Klasse BR 4-S nach EN 1063 / *Bullet resistant glazing, Class BR 4-S according EN 1063*
Prüfzertifikat S 11 0032-04 FB 4-S, Beschussamt Ulm / *Testcertificat S 11 0032-04 FB 4-S, Department of ballistics Ulm*

Pos. Pos.	Klasse / Class (EN 1063)	Mono/Iso Single/Ins	Masse / Weight (kg/m ²)	Dicke / Thickness (mm)	Bezeichnung / Designation	Hersteller / Manufacturer
13	BR 4-S	Mono	63	36	P8B-17	Flachglas Markenkreis GmbH
14	BR 4-S	Iso	68	36	BR 4-S-21	Flachglas Markenkreis GmbH
15	BR 4-S	Iso	78	50	P8B-27	Flachglas Markenkreis GmbH
16	BR 4-S	Iso	90	50	SGG STADIPT CP-HN 432-S	Saint Gobain GmbH
17	BR 4-S	Iso	67	39	SANCO SAFE BR 4-S-ISO-0-39	Glas Trösch GmbH
18	BR 4-S	Mono	80	33	Multistop -BR 4-S-0-33	Glas Trösch GmbH
19	BR 4-S	Iso	72	41	ipasafe BR 4-S Isolierglas	Interpane Sicherheitsglas GmbH & Co
20	BR 4-S	Iso	68	43	Multipact 41 BR 4-S Isolierglas	Glaswerke Arnold GmbH

WICLINE 75 / WICSTYLE 75

Durchschusshemmende, nicht transparente Füllung nach DIN EN 1522

Klasse FB 4-NS

Bullet resistant, opaque infill according DIN EN 1522

Class BR 4-NS

Prüfzertifikat S 11 0032-03 FB 4-NS / Testcertificat S 11 0032-03 FB 4-NS
Prüfzertifikat S 11 0032-04 FB 4-S / Testcertificat S 11 0032-04 FB 4-S
Beschussamt Ulm / Department of ballistics Ulm

Pos. Pos.	Klasse / Class (EN 1522)	Mono/Iso Single/Ins	Masse / Weight (kg/m ²)	Dicke / Thickness (mm)	Bezeichnung / Designation	Hersteller / Manufacturer
21	FB 4-NS	Iso	65	40	Seropal-Paneel	Pohltec GmbH

Hinweis:

Pos.21, durchschusshemmendes, 2-lagiges Paneel mit speziellem Decklagenaufbau auf der Beschussseite aussen.

Note:

Pos.21, bullet resistant double layer panel with special cover sheet compound on the assault side.

WICLINE 65

Blendrahmen
Festverglasung
Frame profile
Fixed glazing

Konstruktionsschnitt
Construction section

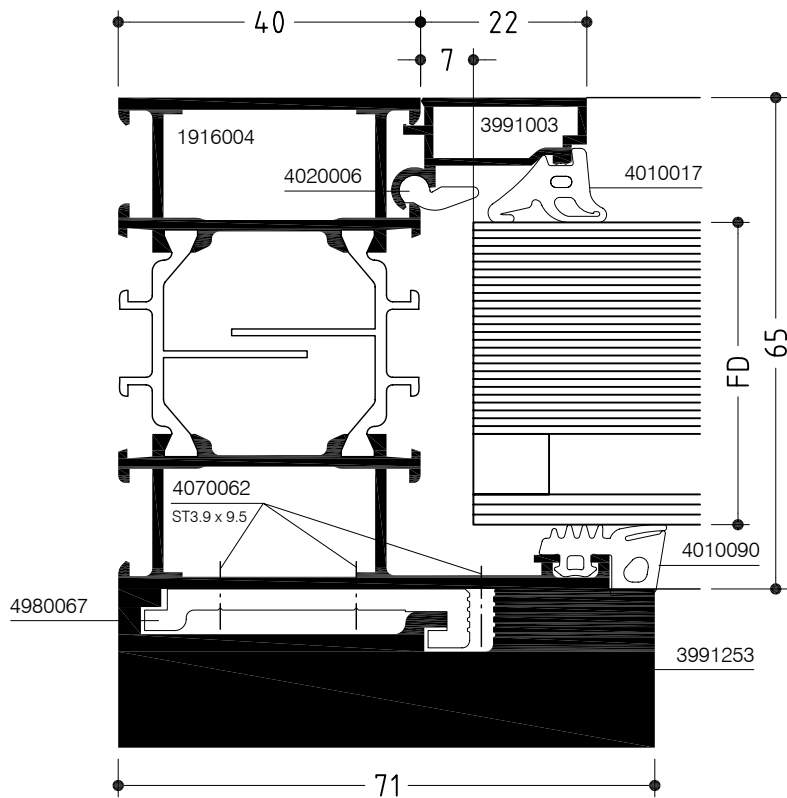

4

WICLINE 65

Konstruktionsschnitt Construction section

Elementkopplung
Festverglasung
Unit coupling
Fixed glazing

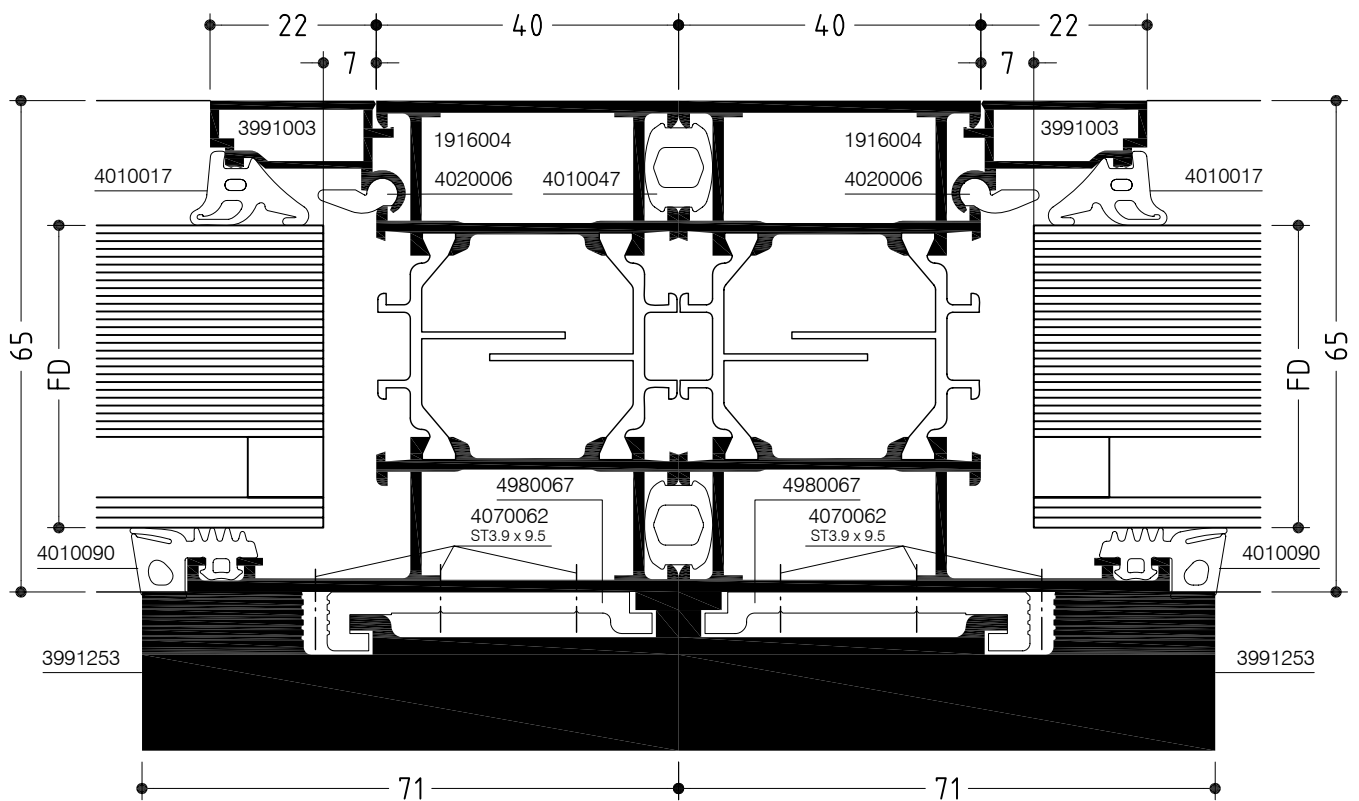
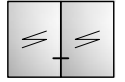

WICLINE 65

Blendrahmen
Fensterflügel
Frame
Window sash

Konstruktionsschnitt
Construction section

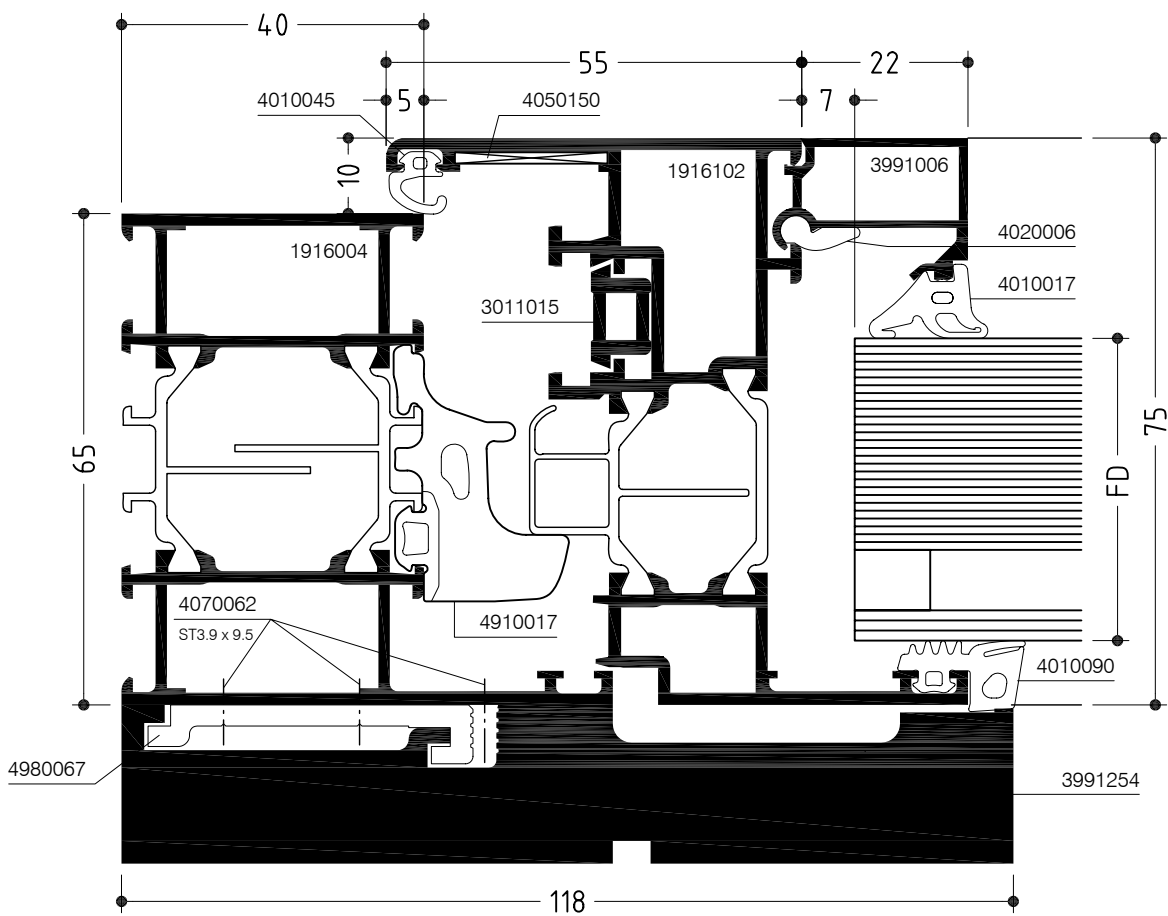

4

WICLINE 65

Kämpferprofil
Festverglasung
Transom profile
Fixed glazing

Konstruktionsschnitt
Construction section

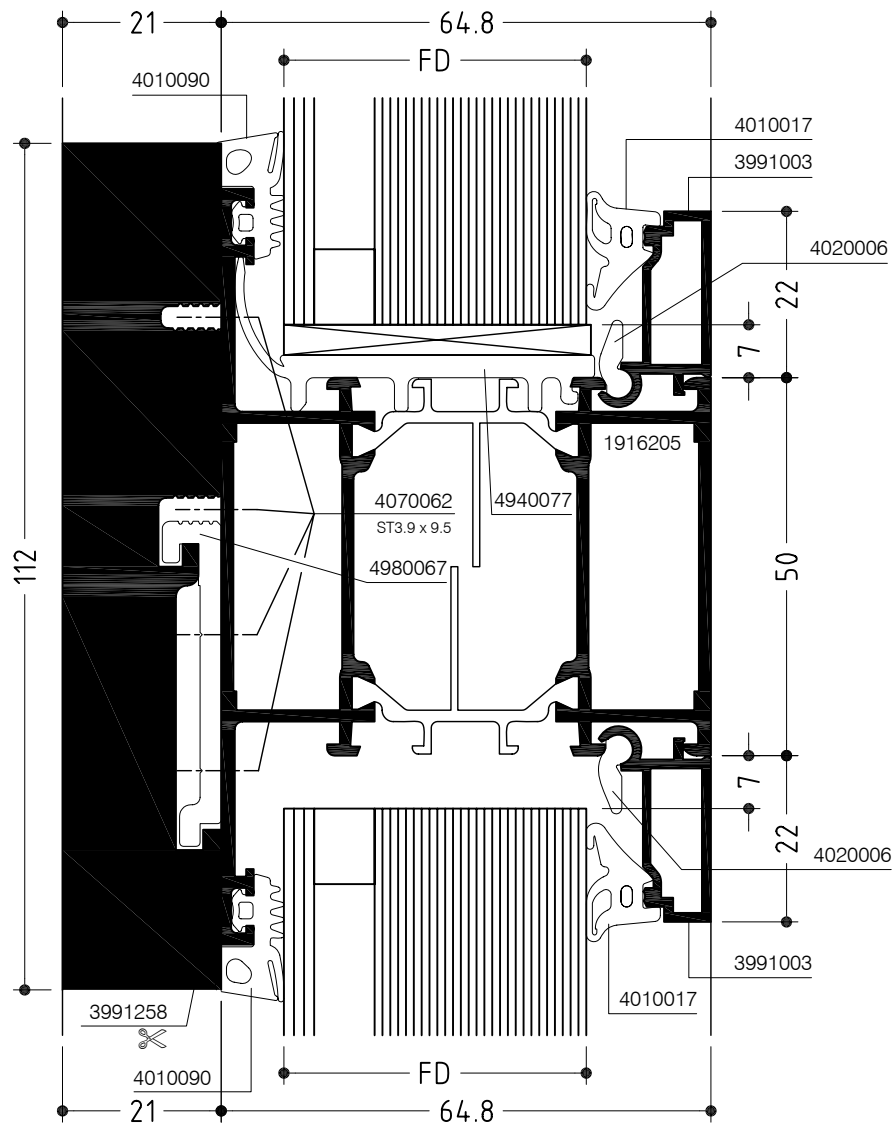
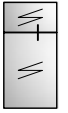

WICLINE 65

Kämpferprofil
Festverglasung
Transom profile
Fixed glazing

Konstruktionsschnitt
Construction section

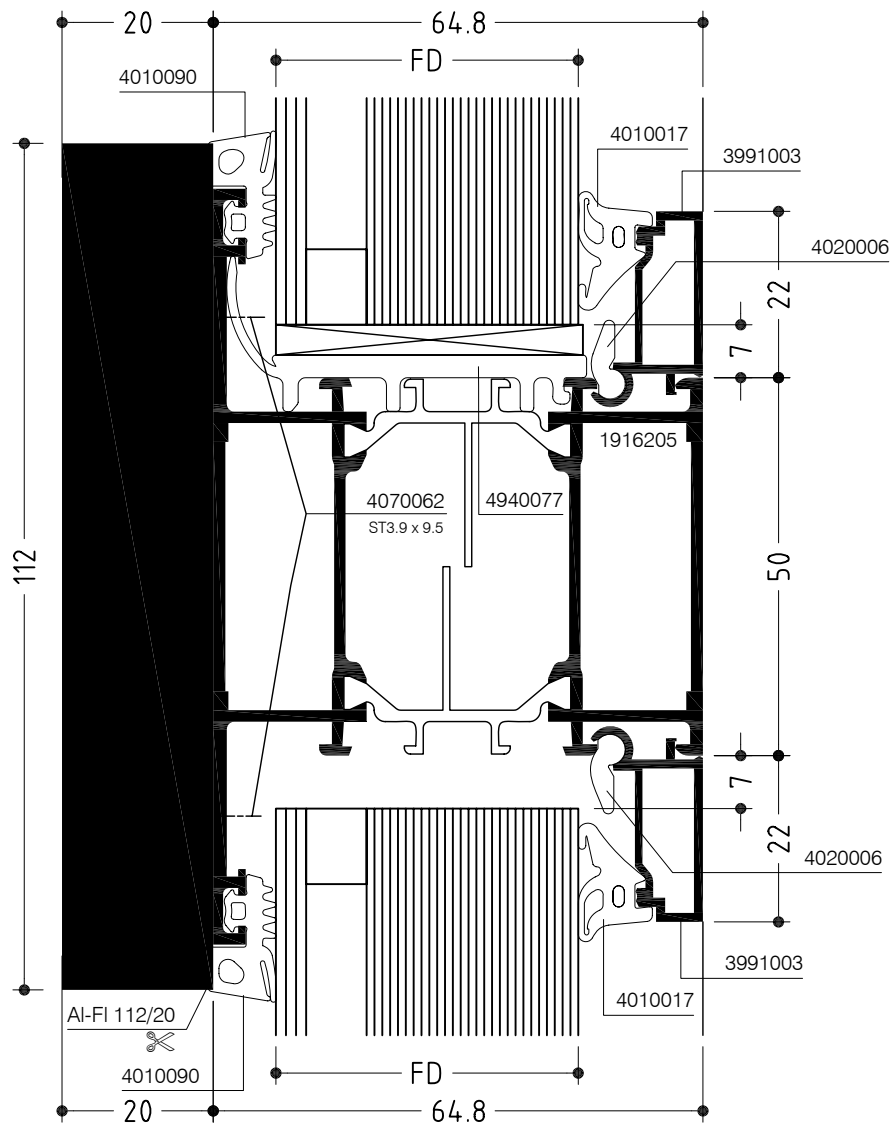
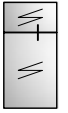

4

WICLINE 75

Blendrahmen
Festverglasung
Frame profile
Fixed glazing

Konstruktionsschnitt
Construction section

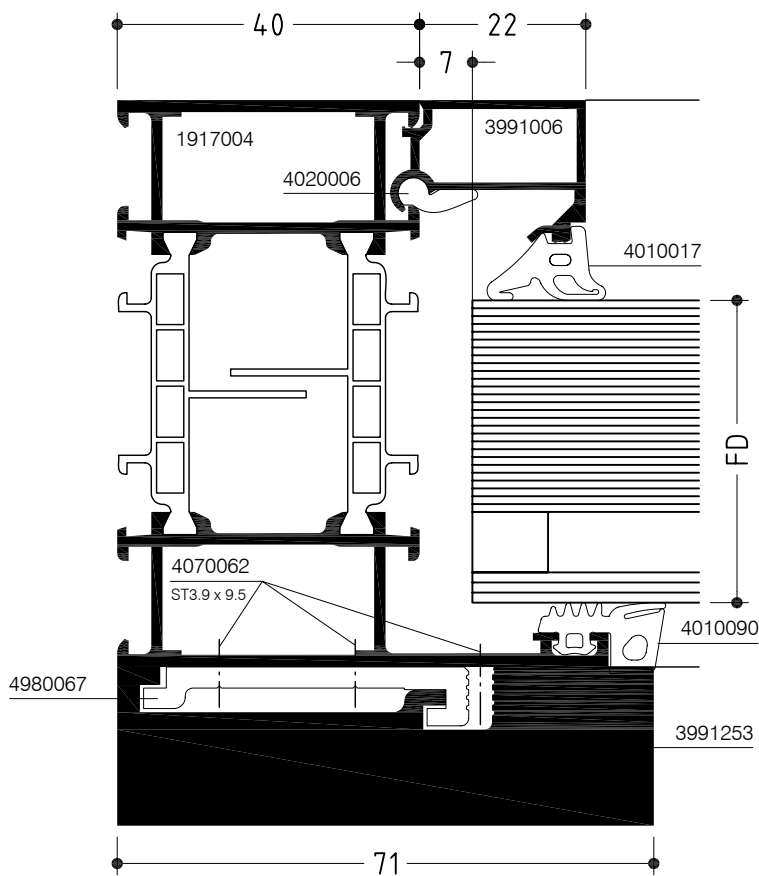

WICLINE 75

Konstruktionsschnitt Construction section

Elementkopplung
Festverglasung
Unit coupling
Fixed glazing

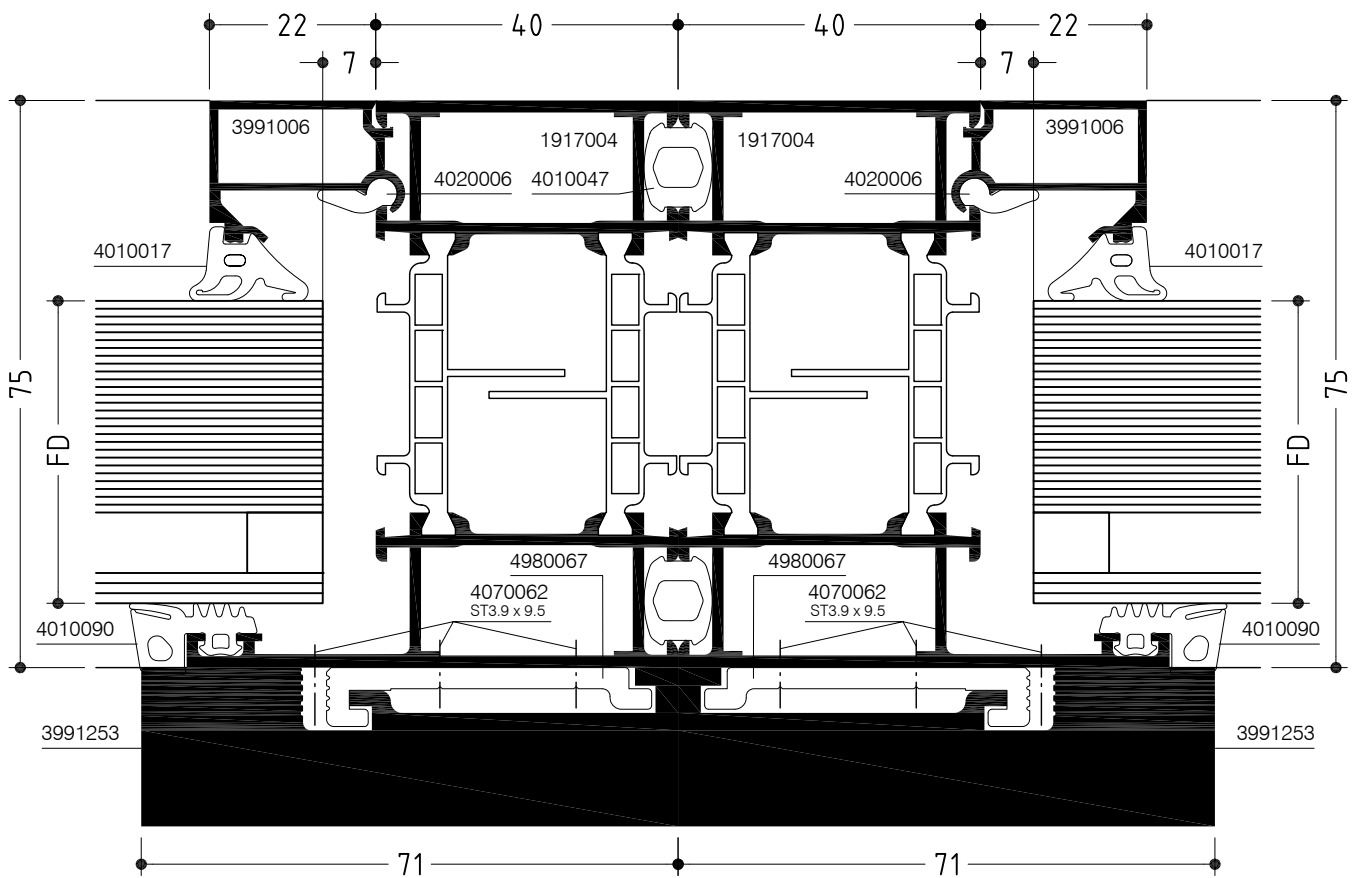
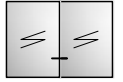

4

WICLINE 75

Blendrahmen
Fensterflügel
Frame profile
Window sash

Konstruktionsschnitt
Construction section

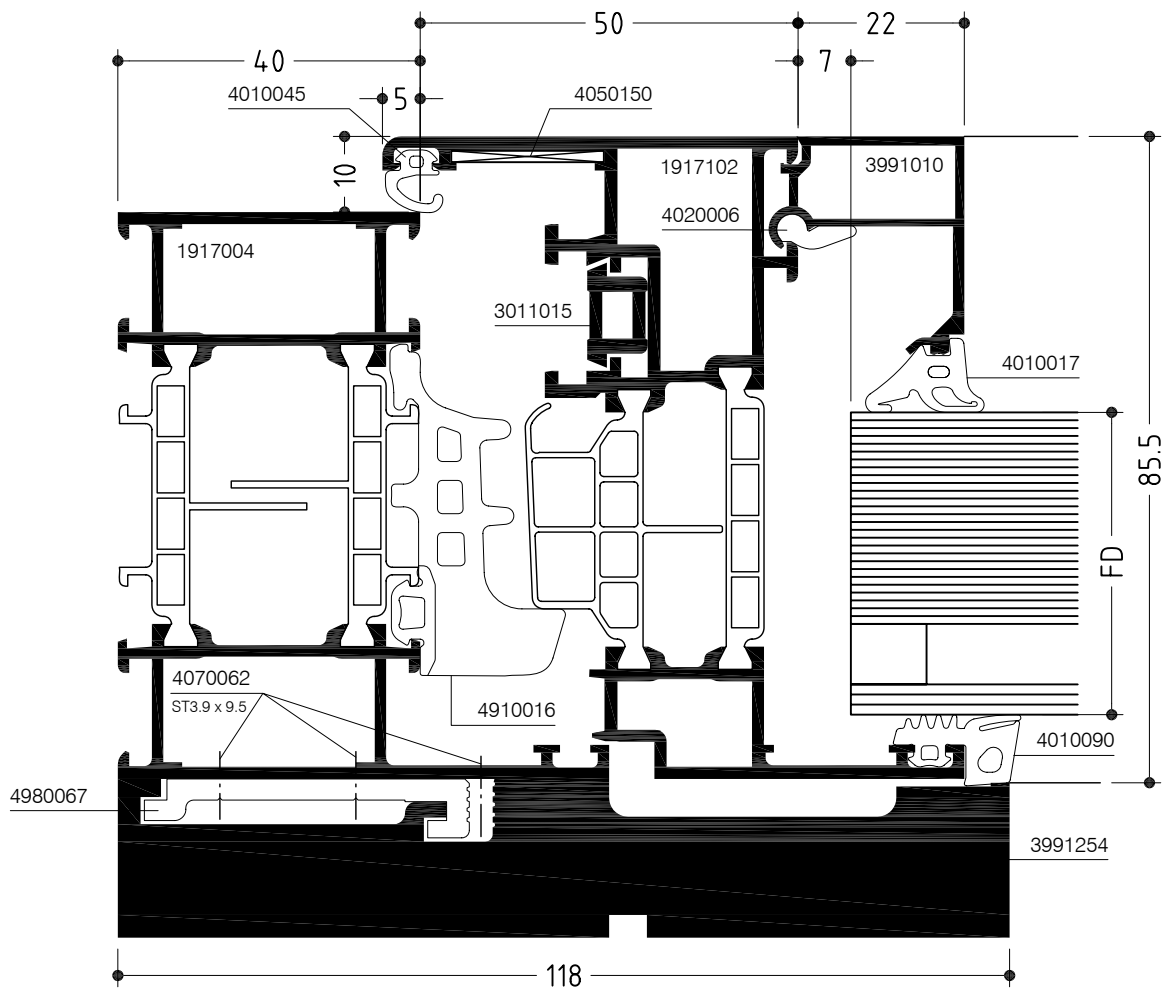

WICLINE 75

Elementkopplung
Fensterflügel / Festverglasung
Unit coupling
Window sash / Fixed glazing

Konstruktionsschnitt
Construction section

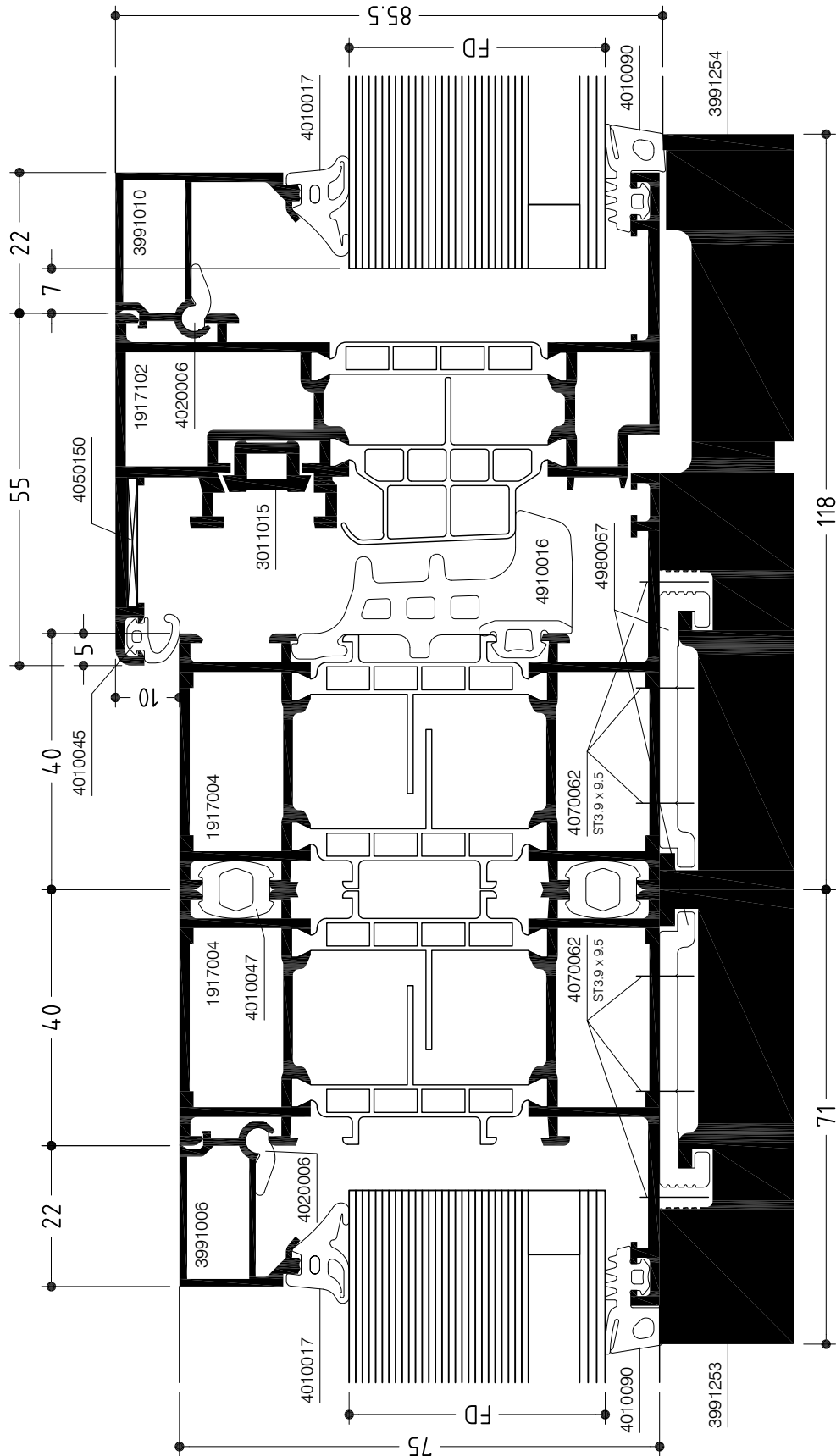
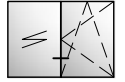

WICLINE 75

Elementkopplung
Fensterflügel
Unit coupling
Window sash

Konstruktionsschnitt
Construction section

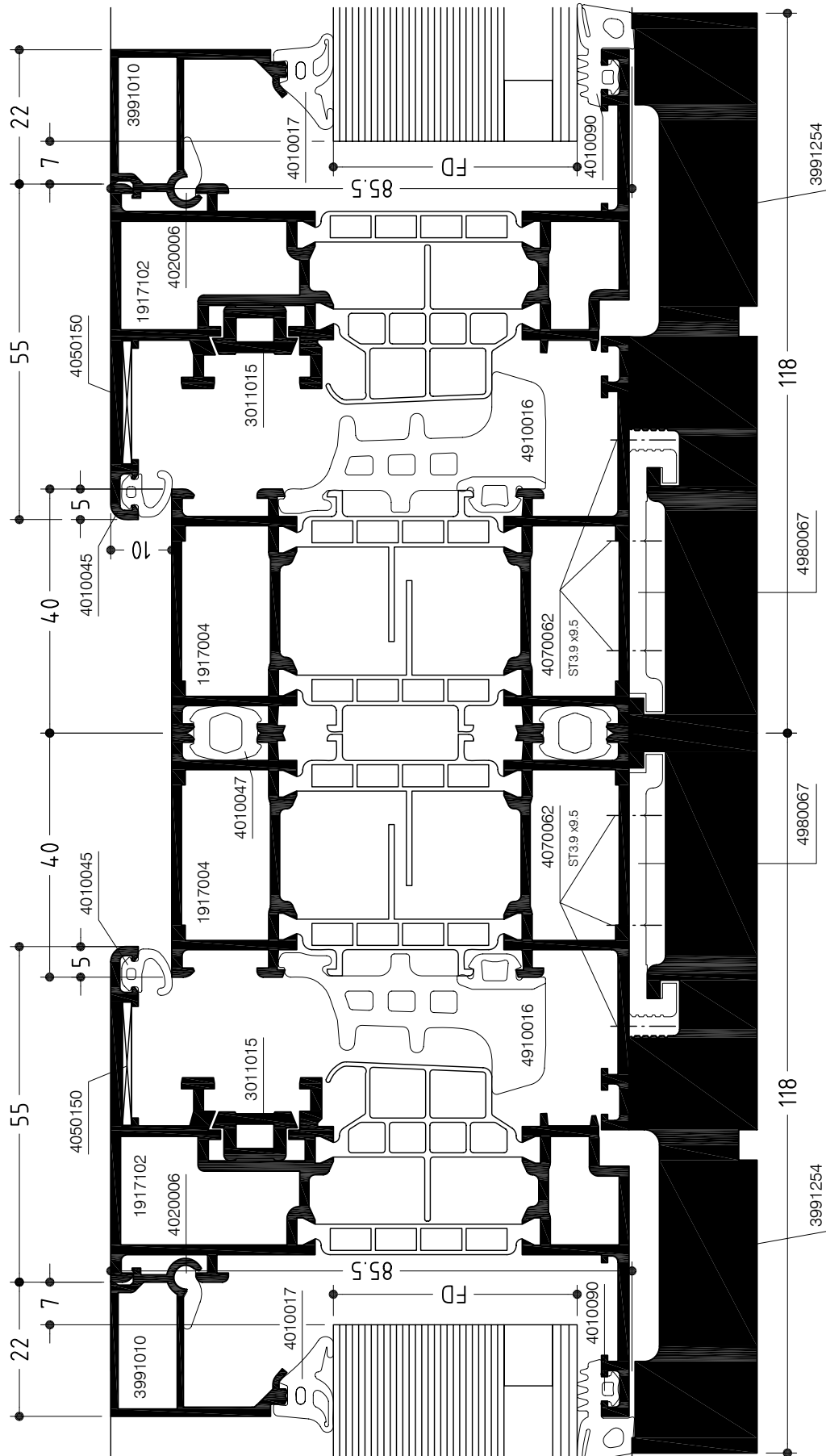

WICLINE 75

Kämpferprofil
Festverglasung
Transom profile
Fixed glazing

Konstruktionsschnitt
Construction section

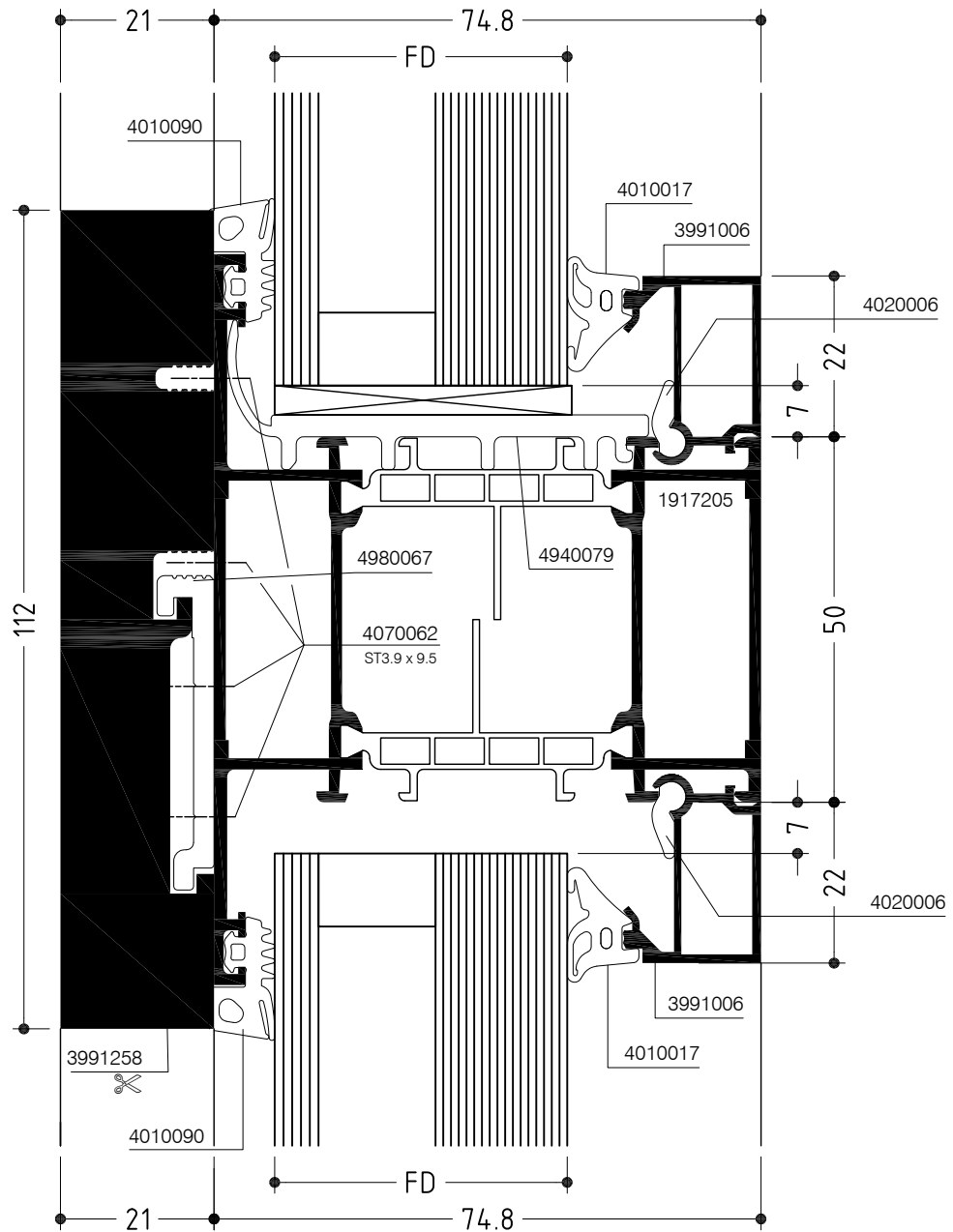
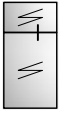

4

WICLINE 75

Kämpferprofil
Festverglasung
Transom profile
Fixed glazing

Konstruktionsschnitt
Construction section

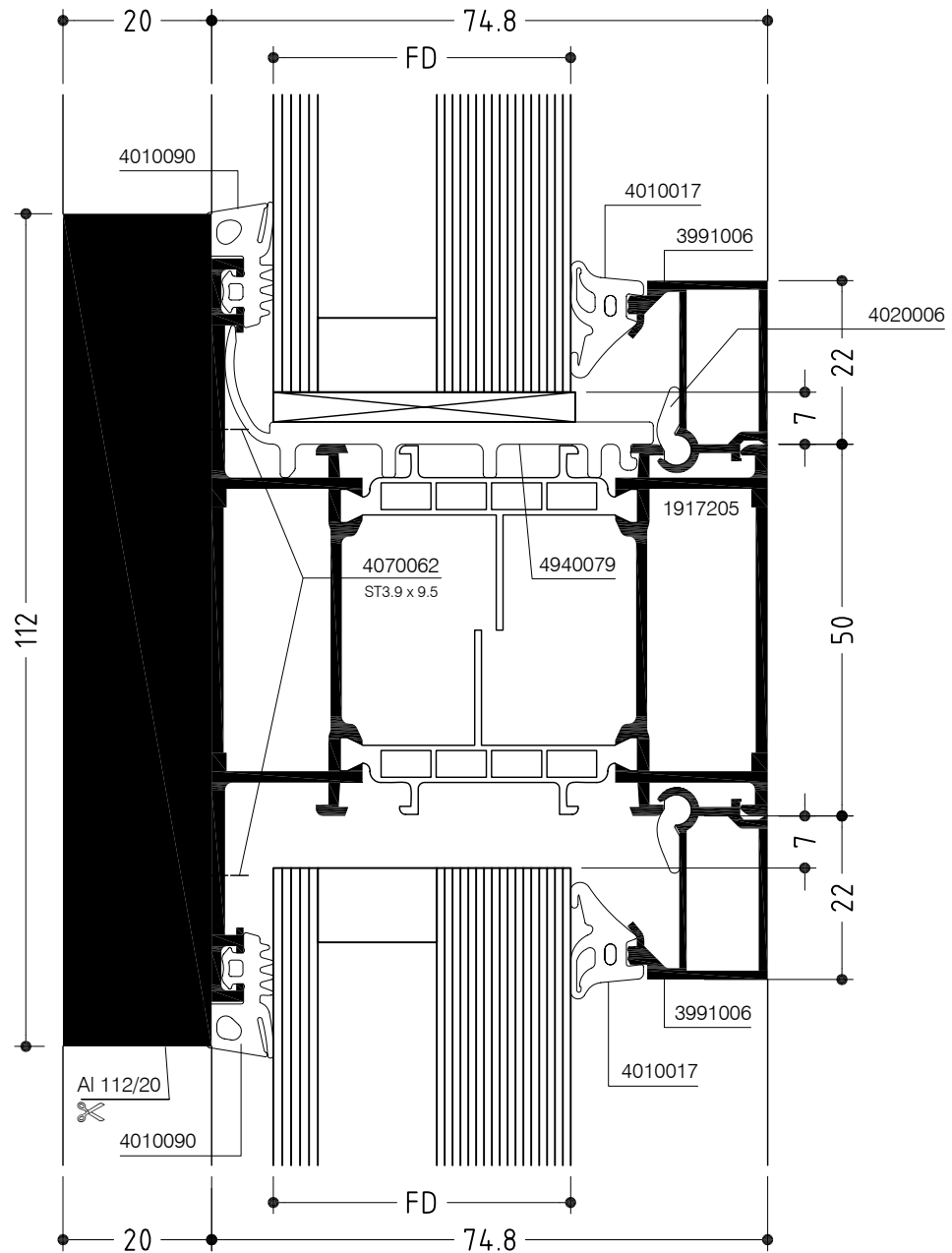
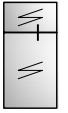

» Brandschutz

Fire protection



Brandschutzfenster

Schutz und Sicherheit – für Ihre Gebäudehüllen benötigen Sie einen Lösungsansatz, der ganzheitlich und mit in sich und untereinander kompatiblen Aluminiumkonstruktionen ausführbar ist.

Diesen bieten die WICONA Serien im Bereich der Fenster, Fassaden und Türen in verschiedensten Ausprägungen, jeweils kombinierbar mit zusätzlichen Funktionen.

Die WICLINE Fensterserien sind bei Bedarf in der Ausführung Brandschutz möglich. Projektspezifische Anforderungen können individuell berücksichtigt werden.

Bitte fragen Sie Ihren zuständigen WICONA Fachberater nach einer persönlichen Beratung.

Fire protection windows

Security and protection – for your building you need a solution approach which can be accomplished with aluminium systems in a wholistic and compatible way.

This is achieved by the WICONA series for windows, curtain walls and doors. Each of them can be equipped with various protection options.

WICLINE windows systems can be executed as fire protective applications. Project specific requirements can be respected individually.













Please ask your WICONA consultant for personal project support.

» Beschläge

Fittings



Symbole / Hinweise
Symbols / Indication

Symbol Symbols	Bezeichnung Designation	Symbol Symbols	Bezeichnung Designation
	Windlast <i>Wind Load</i>		Verdeckte Beschläge <i>Concealed fittings</i>
	Schlagregendichtheit <i>Tightness against driving rain force</i>		
	Einbruchhemmung RC1 N/RC2 N/RC2 DIN EN 1627:2011 <i>Burglary resistance class RC1 N/RC2 N/RC2</i>		
	Einbruchhemmung RC 3 DIN EN 1627:2011 <i>Burglary resistance class WK 3</i>		
	Durchschusshemmung nach DIN EN 1522 <i>Bullet resistance according to DIN EN 1522</i>		
	Maximal zulässiges Flügelgewicht <i>Maximum admissible sash weight</i>		
	Mittelveriegelung (MV) <i>Centre lock (MV)</i>		
	Mittelband (MB) <i>Centre hinge (MB)</i>		
	Wichtiger Hinweis zu beachten! <i>Important hints pay attention to!</i>		1000 Pa = 1 kN/m ² <i>1000 Pa = 1 kN/m²</i>
			Diagramme zulässige Format- größen beachten <i>Mind diagrams admissible format sizes</i>

Hinweis
Indication

Symbol Symbols	Bezeichnung Designation	Symbol Symbols	Bezeichnung Designation
	Dreh-Kipp-Fenster <i>Turn/tilt window</i>		Senk-Klapp-Fenster <i>Italian style window</i>
	Tilt-First -Fenster <i>Tilt-First window</i>		Klapp-Fenster <i>Top-hung window</i>
	Dreh-Fenster <i>Turn window</i>		Schwing-Fenster <i>Horizontal pivot window</i>
	DK-Stulp-Fenster <i>DK - Double casement window</i>		Wende-Fenster <i>Vertical pivot window</i>
	TF-Stulp-Fenster <i>TF-Double casement window</i>		Dreh-Kipp-Fenstertür einwärts, barrierefrei <i>Turn/tilt casement door inwards, accessible</i>
	D-Stulp-Fenster <i>D-Double casement window</i>		Fenstertür einwärts, barrierefrei <i>Casement door inwards, accessible</i>
	Kipp-Fenster, Hochformat <i>Tilt window, portrait</i>		Tilt-First-Fenstertür einwärts, barrierefrei <i>Tilt-First casement door inwards, accessible</i>
	Kipp-Fenster, Querformat <i>Tilt window, landscape</i>		Fenstertür auswärts, barrierefrei <i>Casement door outwards, accessible</i>
	Oberlicht <i>Fanlight</i>		Parallelschiebe-Kippfenster <i>Parallel sliding tilt window</i>

Öffnungsarten
Opening types

Symbol
Symbols

Bezeichnung
Designation



DK-Fenstertür zweiflügelig
einwärts, beidseitig barrierefrei
*Turn/tilt double casement door
inwards, both sided accessible*



Fenstertür zweiflügelig
einwärts, beidseitig barrierefrei
*Double casement door
inwards, both sided accessible*



TF-Fenstertür zweiflügelig
einwärts, beidseitig barrierefrei
*Tilt First double casement door
inwards, both sided accessible*

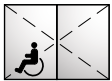

Fenstertür zweiflügelig
auswärts, beidseitig barrierefrei
*Double casement door
outwards, both sided accessible*

WICLINE

Beschläge
Fittings

Zulässige Formatgrößen, aufliegende Beschläge
Admissible format sizes, top mounted fittings

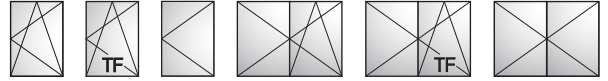

WICSTAR

Flügelgewicht max. 100 kg
Sash weight max. 100 kg

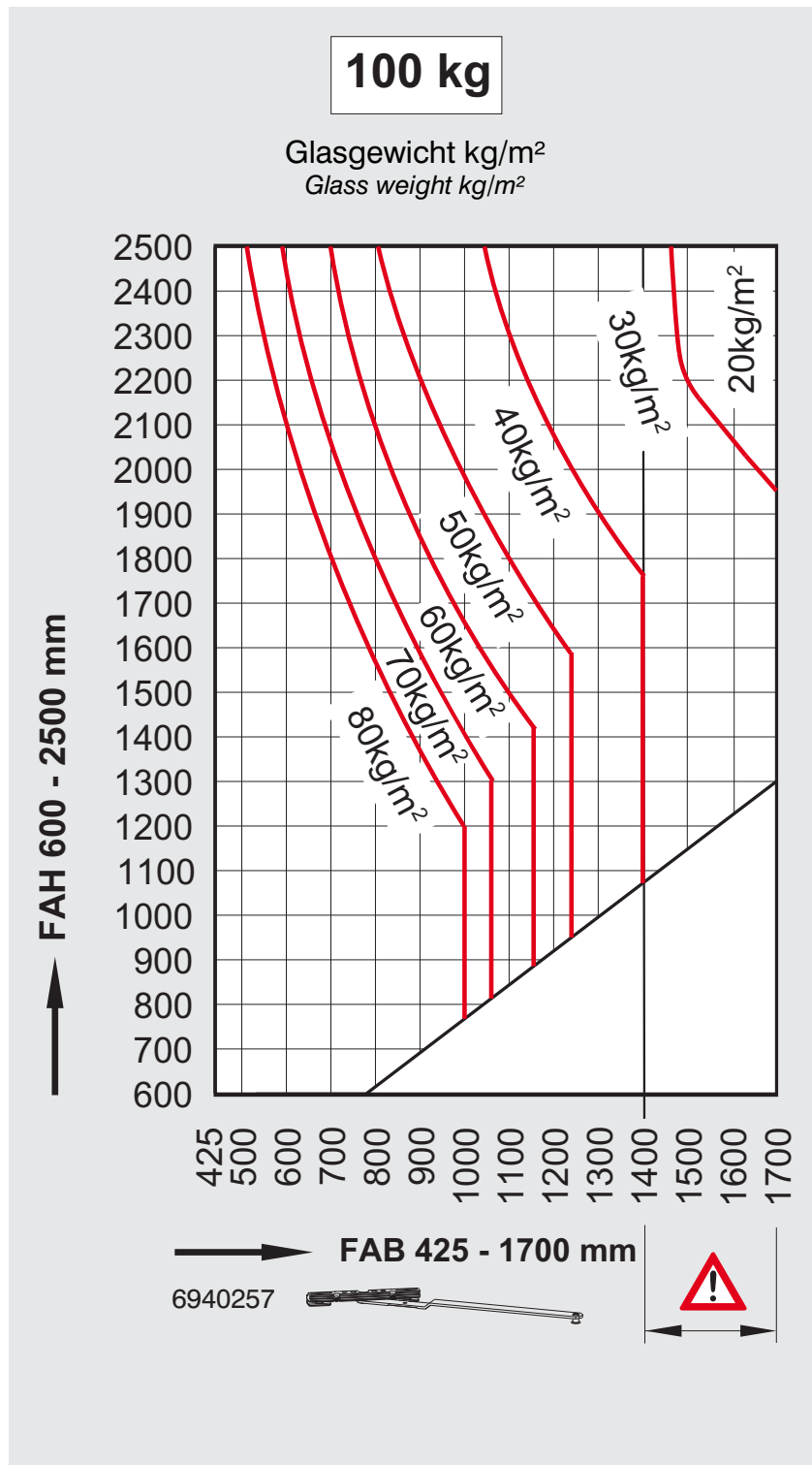

6

Zulässige Formatgrößen, aufliegende Beschläge
Admissible format sizes, top mounted fittings

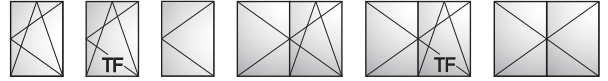

WICSTAR

mit Zusatzschraube Flügelgewicht 100-130 kg
with additional screw sash weight 100-130 kg

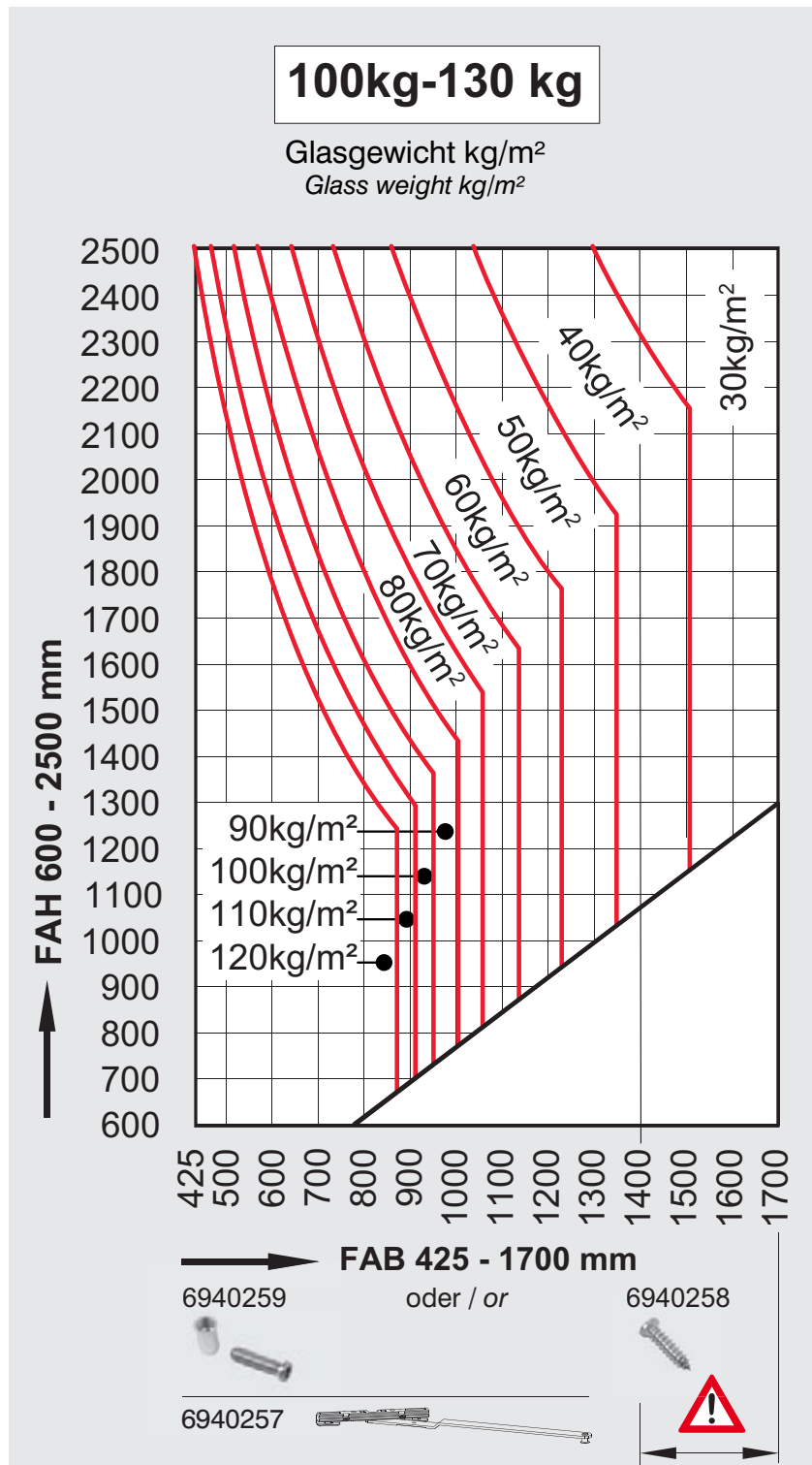

WICLINE

Beschläge
Fittings

Zulässige Formatgrößen, aufliegende Beschläge
Admissible format sizes, top mounted fittings

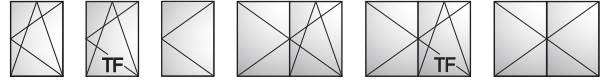

WICSTAR

mit Zusatzschrauben Flügengewicht 130-160 kg
with additional screws sash weight 130-160 kg

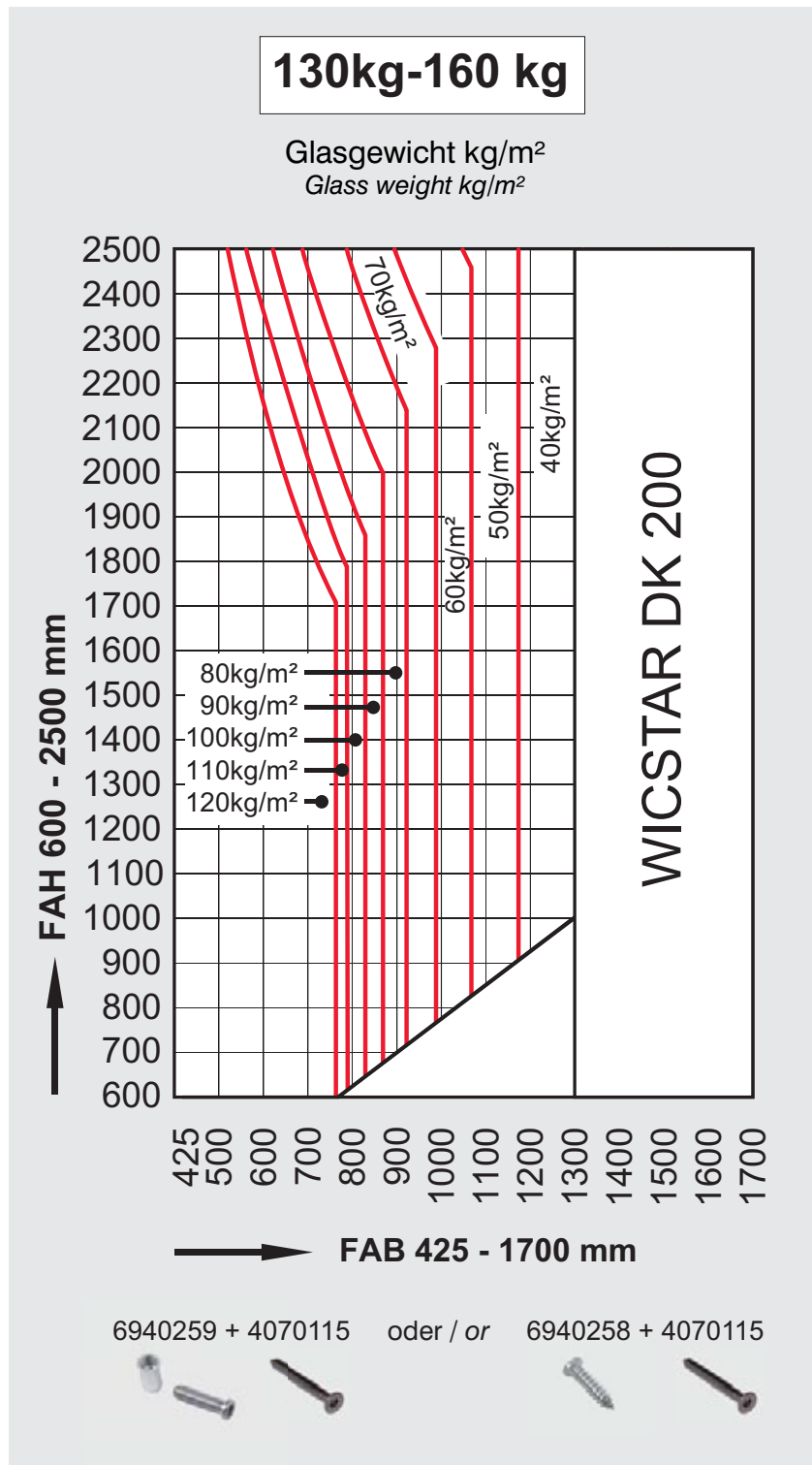

WICLINE

Beschläge
Fittings

Zulässige Formatgrößen, verdeckte Beschläge
Admissible format sizes, concealed fittings

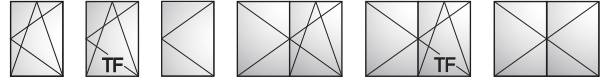

WICSTAR

Flügelgewicht max. 160 kg
Sash weight max. 160 kg

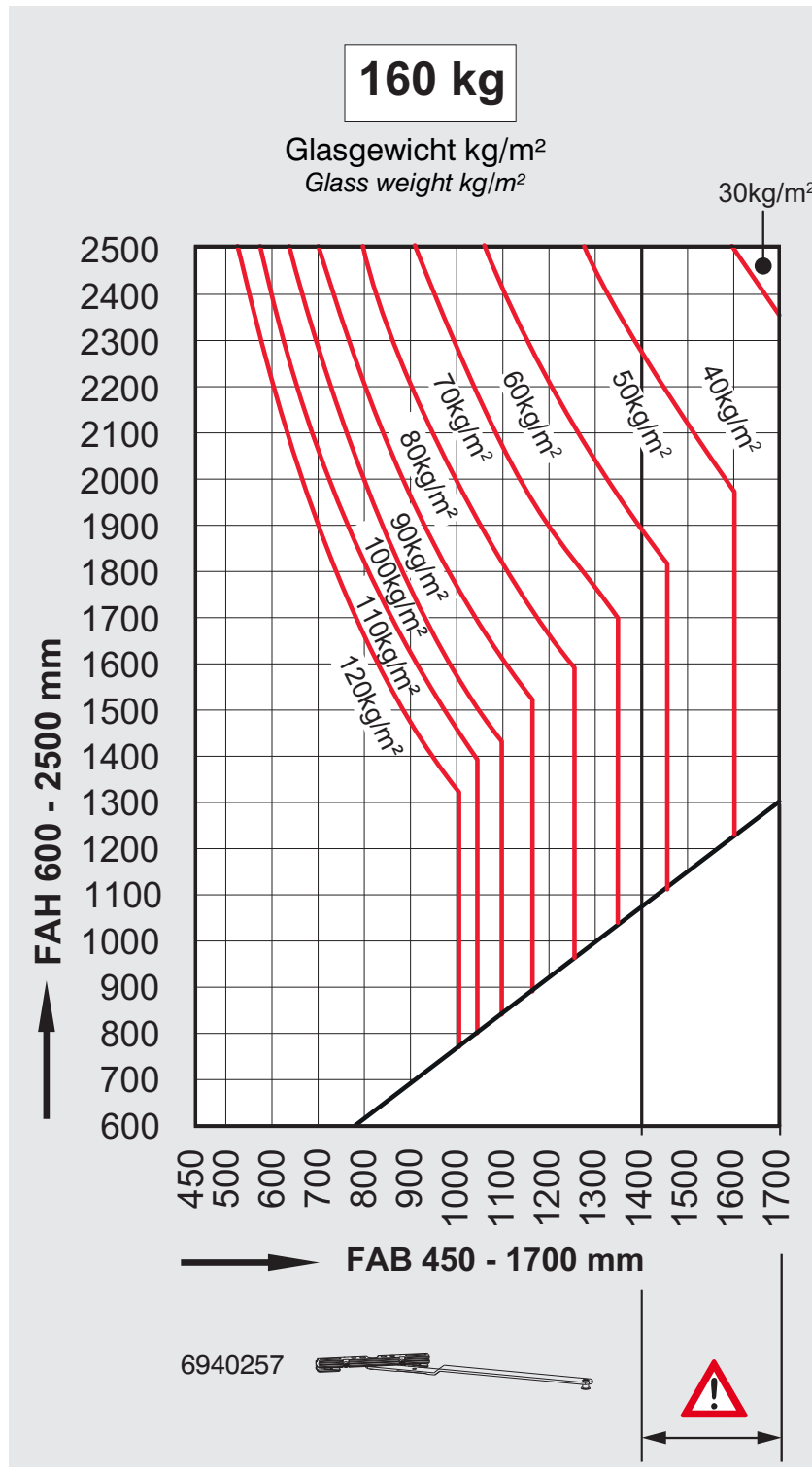

Zulässige Formatgrößen, aufliegende Beschläge
Admissible format sizes, top mounted fittings



WICSTAR

Flügelgewicht max. 200 kg
Sash weight max. 200 kg



Die Befestigung der Bledrahmenbänder erfordert Rahmenprofile mit einer Kammerhöhe ≥ 28 mm (z.B. 1916004)
The fixation of the hinges require frame profiles with a chamber height of 28 mm or higher (e.g. 1916004)

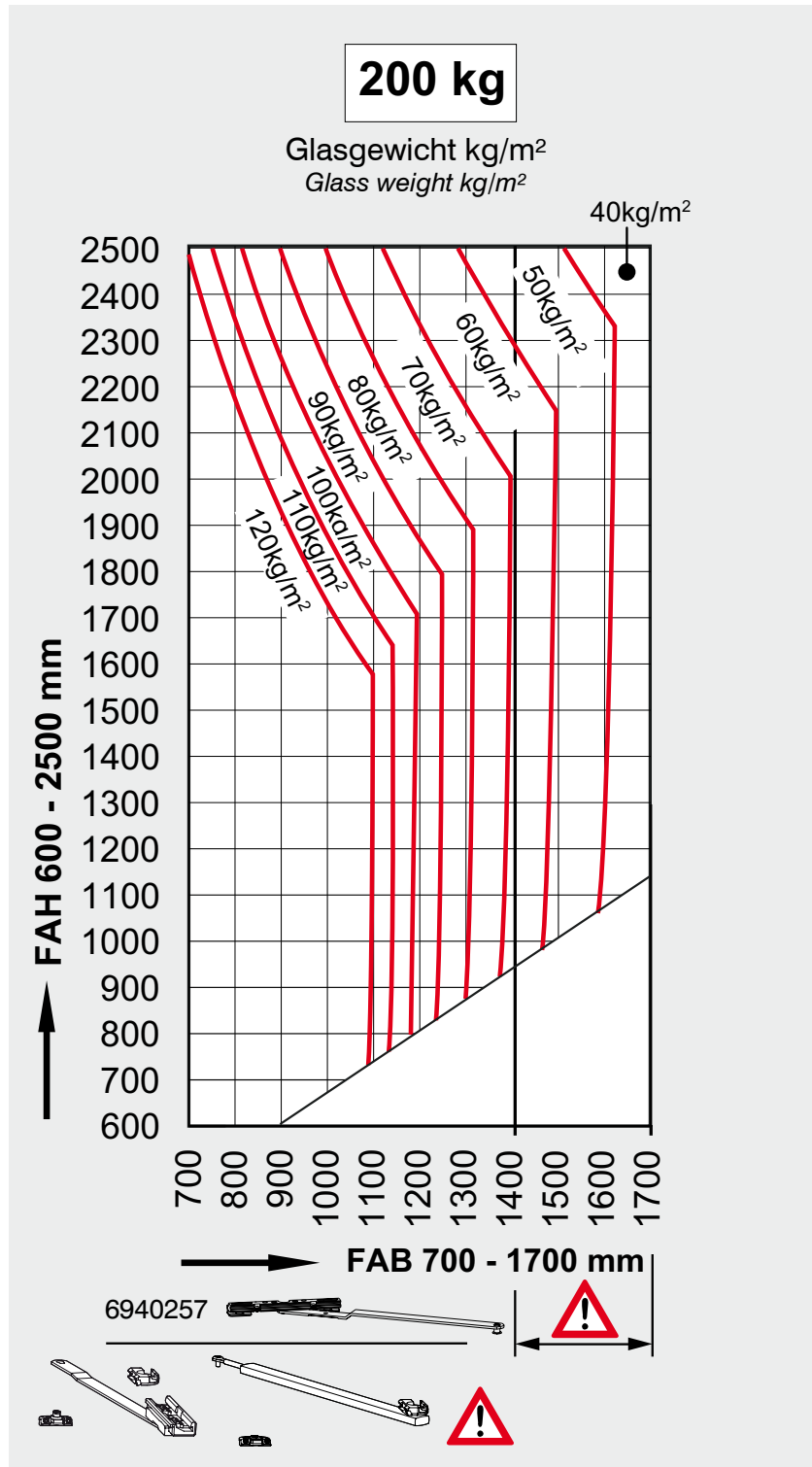

Zulässige Formatgrößen, aufliegende Beschläge
Admissible format sizes, top mounted fittings



WICSTAR

Flügelgewicht max. 200 kg
Sash weight max. 200 kg



Die Befestigung der Bledrahmenbänder erfordert Rahmenprofile mit einer Kammerhöhe ≥ 28 mm (z.B. 1916004)
The fixation of the hinges require frame profiles with a chamber height of 28 mm or higher (e.g. 1916004)

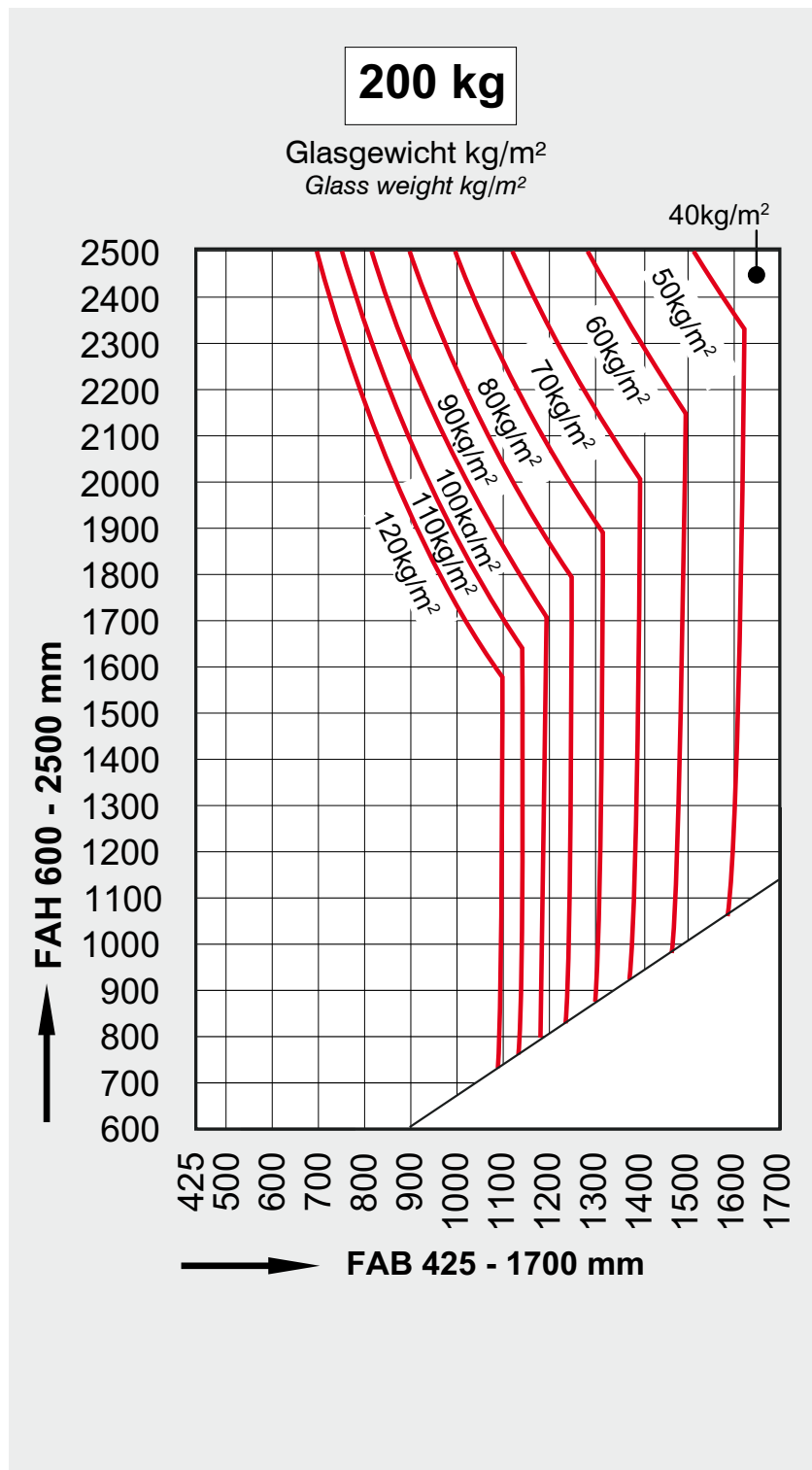

WICLINE

Zulässige Formatgrößen, Standard Beschläge, verdeckte Beschläge
 Admissible format sizes, standard fittings, concealed fittings

WICSTAR

Flügelgewicht max. 130 kg
 Sash weight max. 130 kg

Beschläge
 Fittings

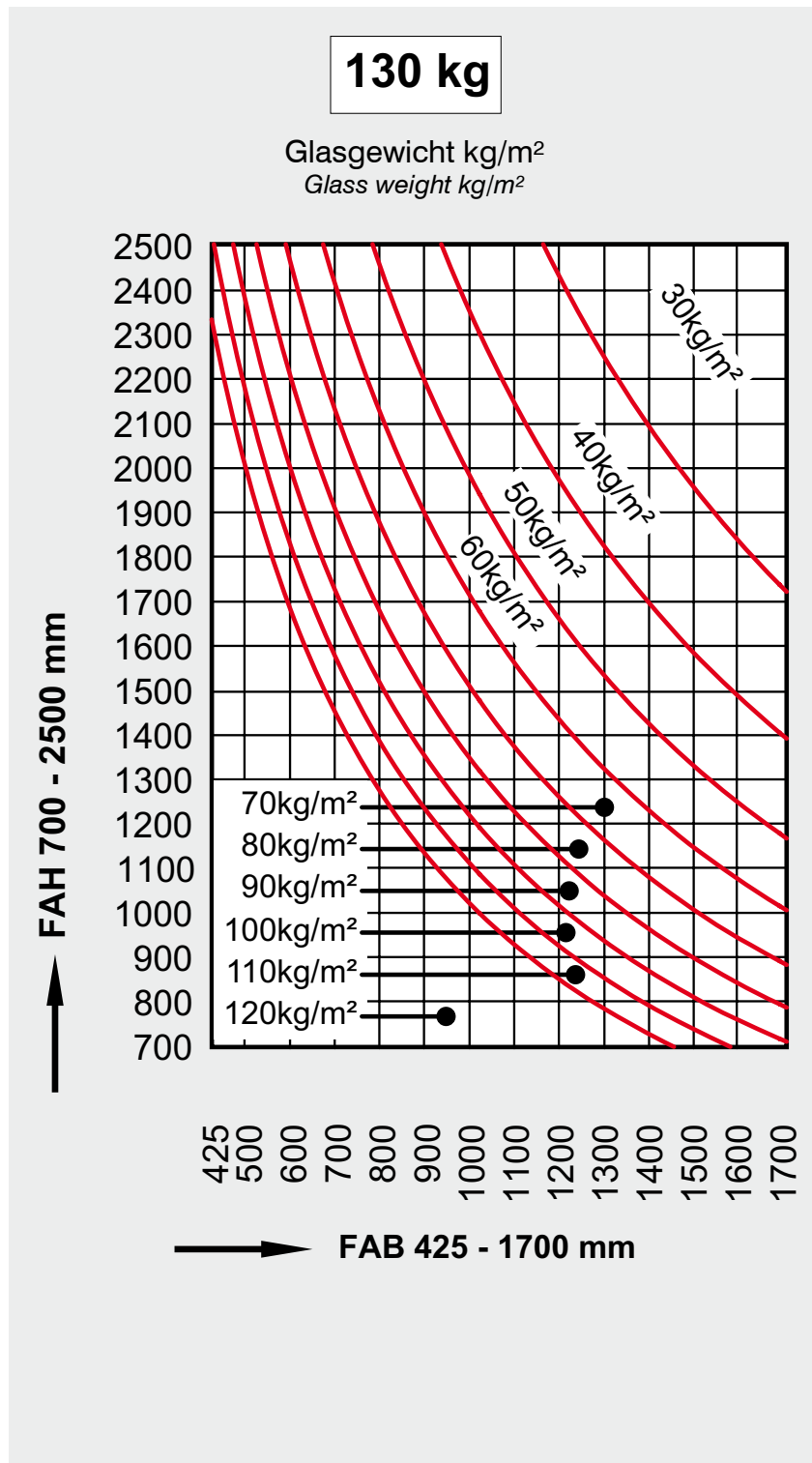

Zulässige Formatgrößen, Standard Beschläge, verdeckte Beschläge
Admissible format sizes, standard fittings, concealed fittings



WICSTAR

Flügelgewicht max. 130 kg
Sash weight max. 130 kg



130 kg

Glasgewicht kg/m²
Glass weight kg/m²

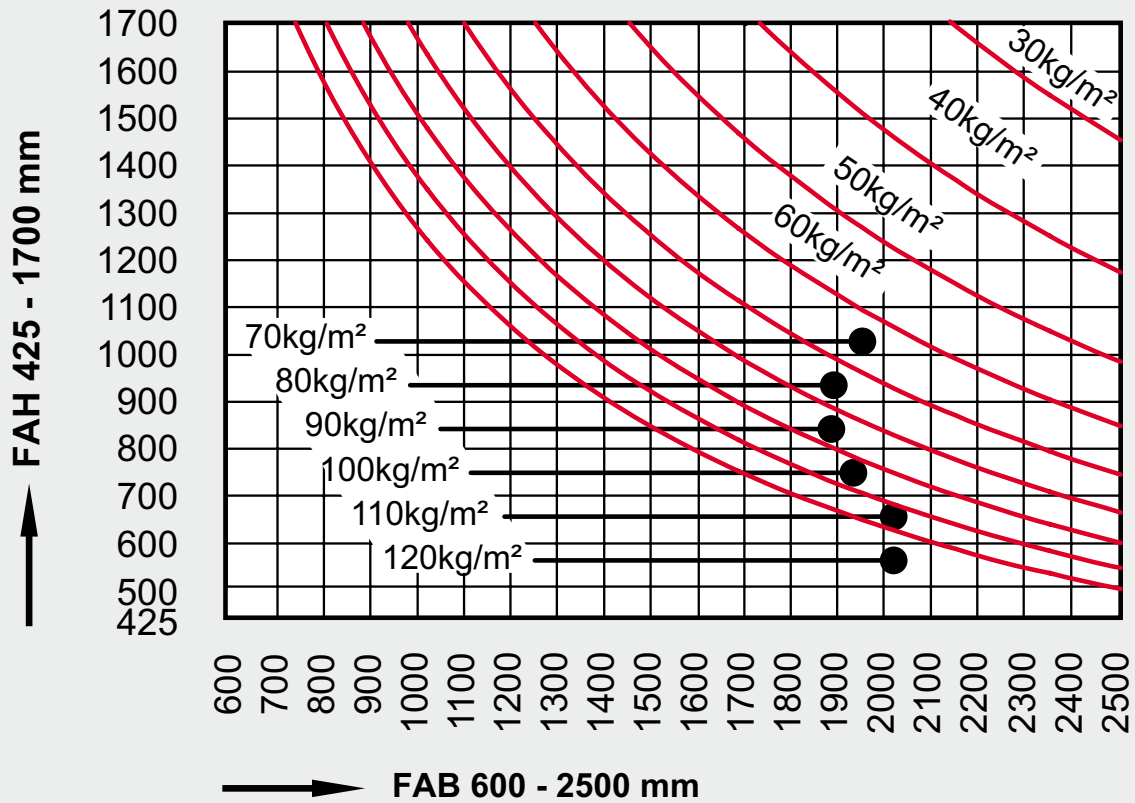

Zulässige Formatgrößen, aufliegende und verdeckte Beschläge
Admissible format sizes, top mounted and concealed fittings



WICSTAR

Flügelgewicht max. 80 kg
Sash weight max. 80 kg

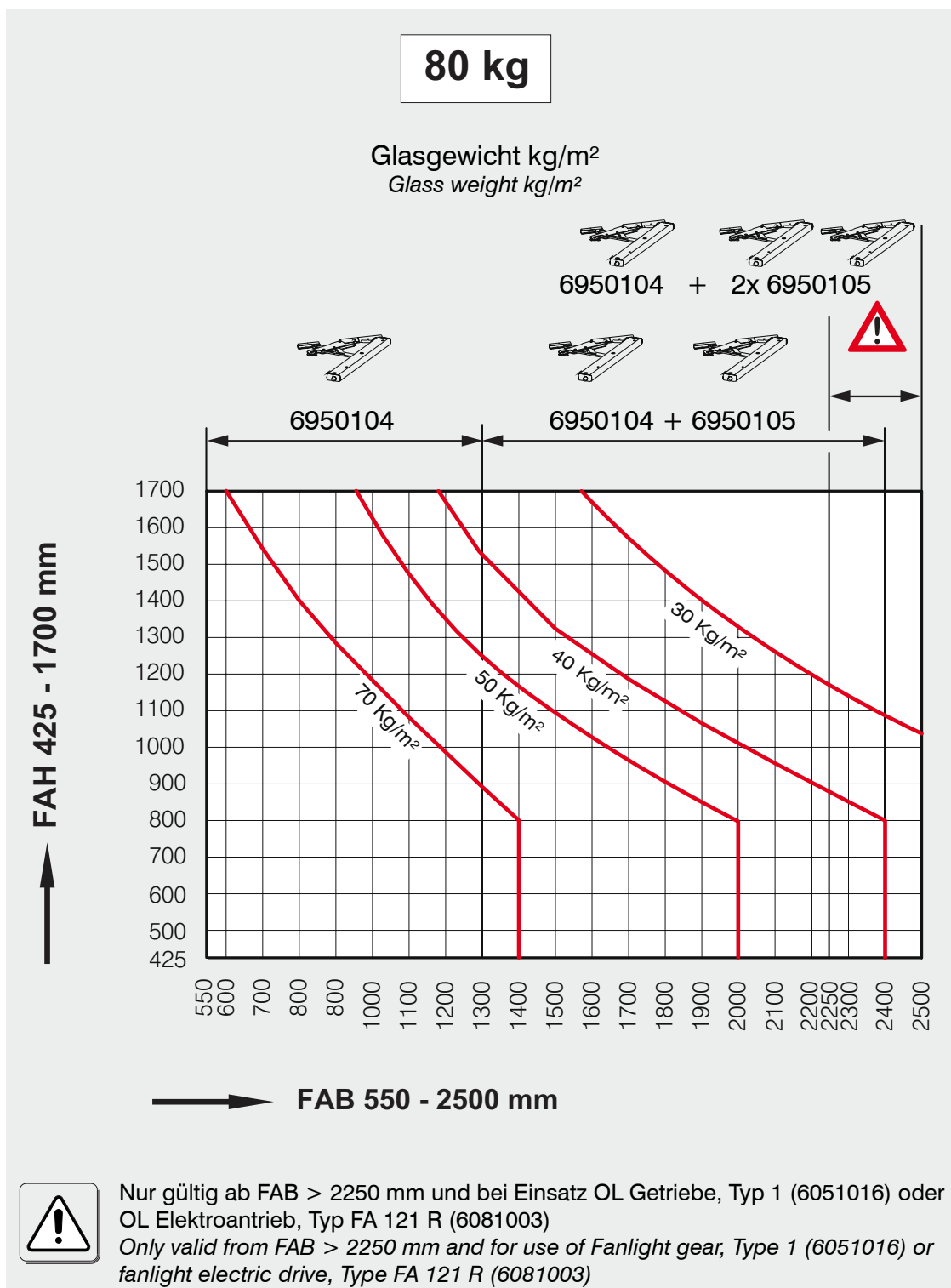

Zulässige Formatgrößen, aufliegende und verdeckte Beschläge
Admissible format sizes, top mounted and concealed fittings



WICSTAR

Flügelgewicht max. 120 kg
Sash weight max. 120 kg

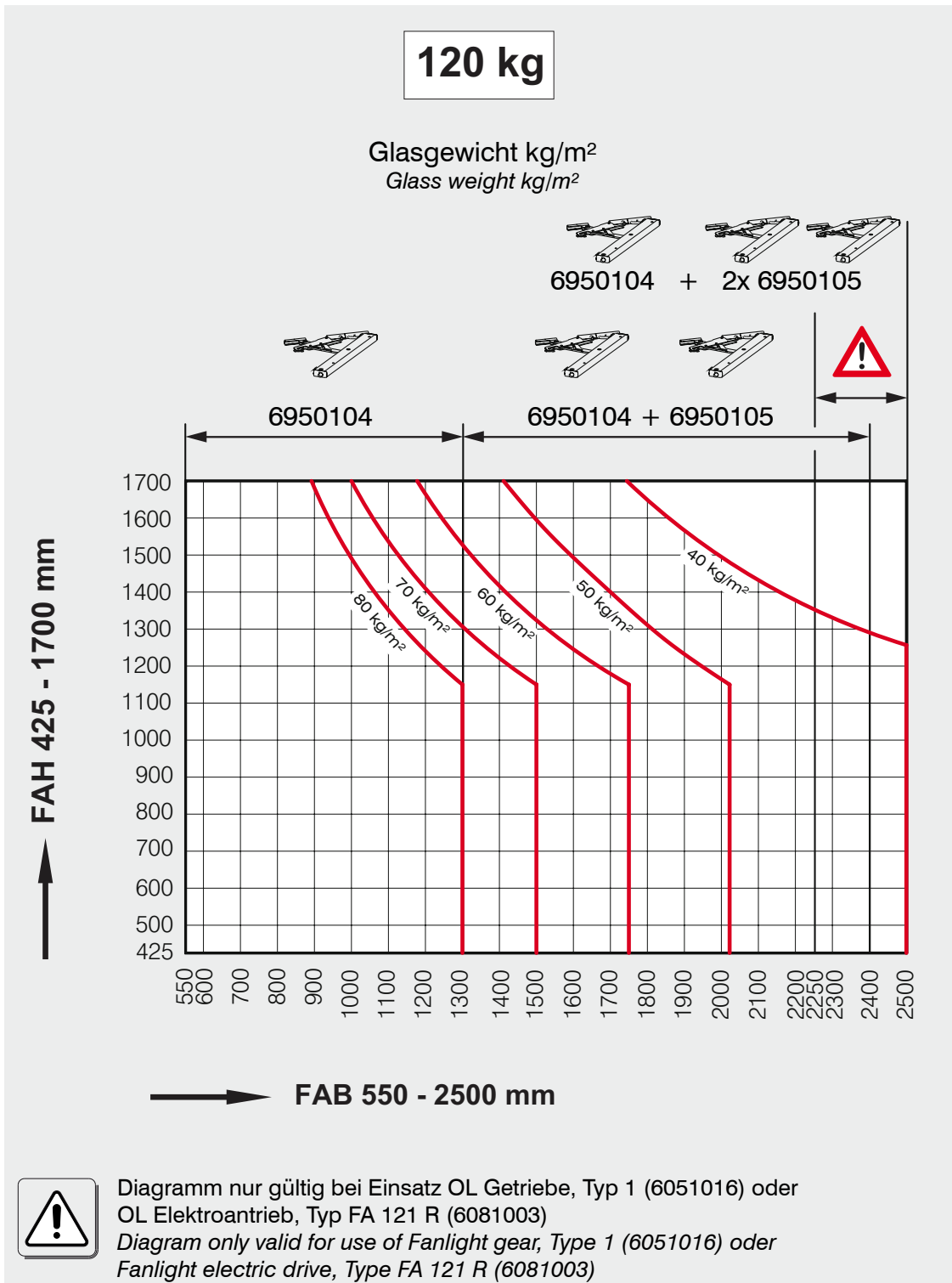

WICLINE 65

Mindest Stulpfenster Format
Minimum double casement window format

Zulässige Flügelgrößen
Admissible sash sizes



Mindest Flügel- und Griffhöhen für Stulp-Beschlag
Minimum sash and handle heights for double casement fitting.

Stulp-Beschlag, Kniehebel
Double casement fitting, toggle lever

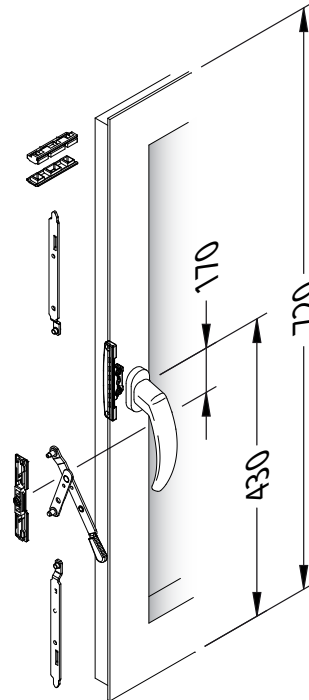

Stulp-Beschlag, Stulpgetriebe
Double casement fitting, double casement gear

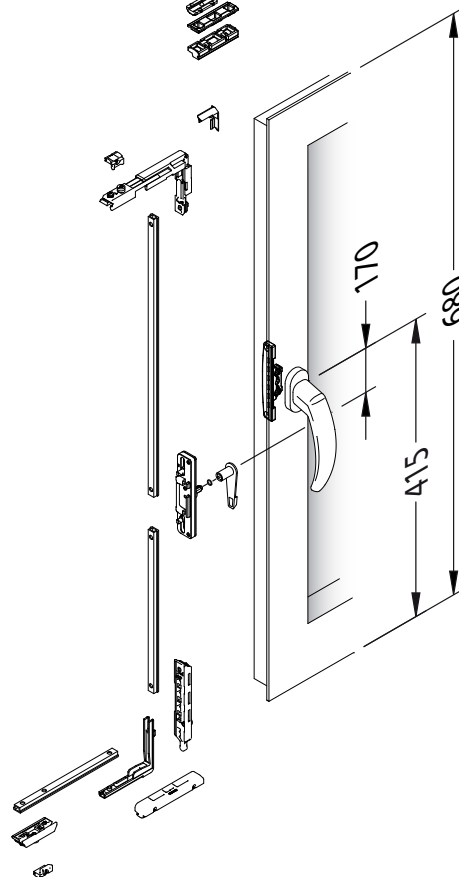

WICLINE 65

Aufliegende Beschläge
Top mounted fittings

Zulässige Flügelgrößen
Admissible sash sizes



Profile Profiles		1916101				1916102				1916103				1916104				1916105				1916115				
	(Pa)	800	1200	2000	-	800	1200	2000	2000	800	1200	2000	2000*	800	1200	2000*	-									
	(Pa)	150	300	600	-	150	300	600	600	150	300	600	600	150	300	600	-									
Flügelgröße Sash size	max.	FAB (m)	1.3	1.2	1.1	-	1.6	1.5	1.4	1.0	1.6	1.6	1.5	1.0	1.7	1.7	1.6	-								
		FAH (m)	1.7	1.7	1.7	-	2.0	2.0	2.0	2.25	2.25	2.25	2.25	2.5	2.5	2.5	2.5	-								
	min.	FAB (m)	0.425	0.425	0.425	-	0.425	0.425	0.425	0.425	0.425	0.425	0.425	0.425	0.425	0.425	0.425	-								
		FAH (m)	0.6	0.6	0.6	-	0.6	0.6	0.6	0.6	0.6	0.6	0.6	0.6	0.6	0.6	0.6	-								
MV / MB	FAB (m)	-	-	-	-	-	-	1.3	-	-	-	1.3	-	-	-	1.3	-									
	FAH (m)	1.5	1.5	1.3	-	1.7	1.6	1.5	1.5	1.8	1.7	1.6	1.5*	1.8	1.7	1.6*	-									
	min.	FAB (m)	0.425	0.425	0.425	-	0.425	0.425	0.425	0.425	0.425	0.425	0.425	0.425	0.425	0.425	0.425	-								
		FAH (m)	0.83	0.83	0.83	-	0.83	0.83	0.83	0.83	0.83	0.83	0.83	0.83	0.83	0.83	0.83	-								
	min.	FAB (m)	0.65	0.65	0.65	-	0.65	0.65	0.65	0.65	0.65	0.65	0.65	0.65	0.65	0.65	0.65	-								
		FAH (m)	0.9	0.9	0.9	-	0.9	0.9	0.9	0.9	0.9	0.9	0.9	0.9	0.9	0.9	0.9	-								
	max. (kg)	100 (Klotzabst. 50 mm zur Ecke) (Shim dist. to corner 50 mm)				160				200																

* Windlast > 1600 Pa und FAH > 2.25 m werden zwei vertikale Zusatzverriegelungen benötigt
* Wind load > 1600 Pa and FAH 2.25 m requires two vertical additional locking points

WICLINE 65

Aufliegende Beschläge
Top mounted fittings

Zulässige Flügelgrößen
Admissible sash sizes



Profile
Profiles

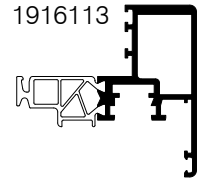
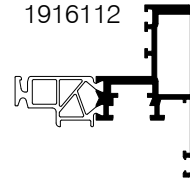
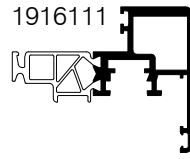
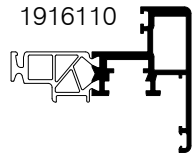

	(Pa)	800	1200	2000	-	800	1200	2000	-	800	1200	2000	-	800	1200	2000	-	
	(Pa)	150	300	600	-	150	300	600	-	150	300	600	-	150	300	600	-	
Flügelgröße Sash size	max.	FAB (m)	1.2	1.1	1.0	-	1.3	1.2	1.1	-	1.4	1.3	1.2	-	1.4	1.4	1.3	-
		FAH (m)	1.4	1.4	1.4	-	1.6	1.6	1.6	-	1.7	1.7	1.7	-	1.8	1.8	1.8	-
	min.	FAB (m)	0.425	0.425	0.425	-	0.425	0.425	0.425	-	0.425	0.425	0.425	-	0.425	0.425	0.425	-
		FAH (m)	0.6	0.6	0.6	-	0.6	0.6	0.6	-	0.6	0.6	0.6	-	0.6	0.6	0.6	-
MV / MB	FAB (m)	-	-	-	-	-	-	-	-	-	-	-	-	-	-	-	-	
	FAH (m)	1.3	1.2	1.1	-	1.4	1.3	1.2	-	1.5	1.4	1.3	-	1.5	1.5	1.4	-	
	min.	FAB (m)	0.425	0.425	0.425	-	0.425	0.425	0.425	-	0.425	0.425	0.425	-	0.425	0.425	0.425	-
		FAH (m)	0.83	0.83	0.83	-	0.83	0.83	0.83	-	0.83	0.83	0.83	-	0.83	0.83	0.83	-
	min.	FAB (m)	0.65	0.65	0.65	-	0.65	0.65	0.65	-	0.65	0.65	0.65	-	0.65	0.65	0.65	-
		FAH (m)	0.9	0.9	0.9	-	0.9	0.9	0.9	-	0.9	0.9	0.9	-	0.9	0.9	0.9	-
	max. (kg)	80				100				100				100				

WICLINE 65

Aufliegende Beschläge
Top mounted fittings

Zulässige Flügelgrößen
Admissible sash sizes



Profile Profiles		1916112				1916113													
	(Pa)	800	1200	2000	-	800	1200	2000	-										
	(Pa)	150	300	600	-	150	300	600	-										
Flügelgröße Sash size	max.	FAB (m)	1.4	1.3	1.2	-	1.4	1.4	1.3	-									
		FAH (m)	1.8	2.0	2.1	-	2.0	2.0	2.25	-									
	min.	FAB (m)	0.425	0.425	0.425	-	0.425	0.425	0.425	-									
		FAH (m)	0.6	0.6	0.6	-	0.6	0.6	0.6	-									
MV / MB	FAB (m)	-	-	-	-	-	-	-	-										
	FAH (m)	1.5	1.4	1.3	-	1.5	1.5	1.4	-										
	min.	FAB (m)	0.425	0.425	0.425	-	0.425	0.425	0.425	-									
		FAH (m)	0.83	0.83	0.83	-	0.83	0.83	0.83	-									
	min.	FAB (m)	0.65	0.65	0.65	-	0.65	0.65	0.65	-									
		FAH (m)	0.9	0.9	0.9	-	0.9	0.9	0.9	-									
	max. (kg)	130***				130***													







*** Zusätzliche Verklebung, Angaben in den Verarbeitungsrichtlinien beachten!
*** Additional gluing, pay attention to specifications in the workshop manual!

WICLINE 65

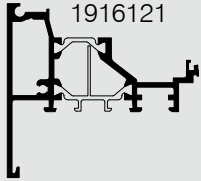
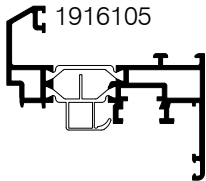
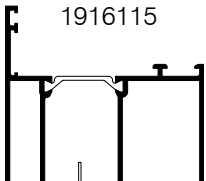
Aufliegende Beschläge
Top mounted fittings

Zulässige Flügelgrößen
Admissible sash sizes



Profile Profiles		1916101				1916102				1916103				1916104				
																		
Stulpaufsatzprofil mit Stulpgetriebe Double casement supplement profile with double casement gear																		
	(Pa) (m ²)**	800	1200	1600 (1.5)**	-	800	1200	1600 (1.7)**	1600 (1.7)**	800	1200	1600 (1.8)**	1600* (1.8)**	800	1200	1600* (2.0)**	-	
	(Pa)	150	300	600	-	150	300	600	600	150	300	600	600	150	300	450	-	
Flügelgröße Sash size	max.	FAB (m)	1.3	1.2	1.1	-	1.6	1.5	1.4	1.0	1.6	1.6	1.5	1.0	1.7	1.7	1.6	-
		FAH (m)	1.7	1.7	1.7	-	2.0	2.0	2.0	2.25	2.25	2.25	2.25	2.5	2.5	2.5	2.5	-
	min.	FAB (m)	0.425	0.425	0.425	-	0.425	0.425	0.425	0.425	0.425	0.425	0.425	0.425	0.425	0.425	0.425	-
		FAH (m)	0.68	0.68	0.68	-	0.68	0.68	0.68	0.68	0.68	0.68	0.68	0.68	0.68	0.68	0.68	-
MV / MB	FAB (m)	-	-	-	-	-	-	1.3	-	1.3	1.3	1.3	-	1.3	1.3	1.3	-	
	FAH (m)	1.5	1.5	1.3	-	1.7	1.6	1.5	1.5	1.8	1.7	1.6	1.5*	1.8	1.7	1.6*	-	
	min.	FAB (m)	0.65	0.65	0.65	-	0.65	0.65	0.65	0.65	0.65	0.65	0.65	0.65	0.65	0.65	0.65	-
		FAH (m)	1.05	1.05	1.05	-	1.05	1.05	1.05	1.05	1.05	1.05	1.05	1.05	1.05	1.05	1.05	-
	min.	FAB (m)	0.65	0.65	0.65	-	0.65	0.65	0.65	0.65	0.65	0.65	0.65	0.65	0.65	0.65	0.65	-
		FAH (m)	1.12	1.12	1.12	-	1.12	1.12	1.12	1.12	1.12	1.12	1.12	1.12	1.12	1.12	1.12	-
	max. (kg)	100 (Klotzabst. 50 mm zur Ecke) (Shim dist. to corner 50 mm)				160												

* Windlast > 1200 Pa und FAH > 2.25 m werden zwei vertikale Zusatzverriegelungen benötigt
* Wind load > 1200 Pa and FAH > 2.25 m requires two vertical additional locking points

** Flügelgröße > () m² benötigt eine horizontale Zusatzverriegelung
** Sash size > () m² requires a horizontal additional locking points

WICLINE 65

Aufliegende Beschläge
Top mounted fittings

Zulässige Flügelgrößen
Admissible sash sizes



Profile
Profiles

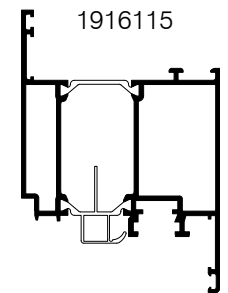
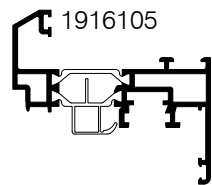
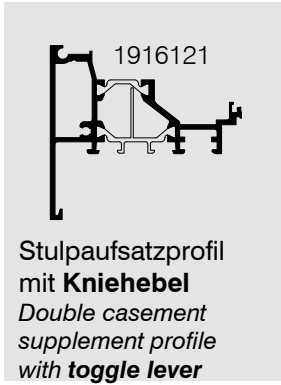
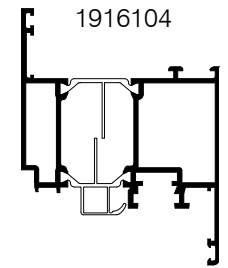
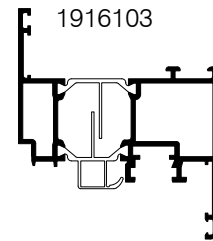
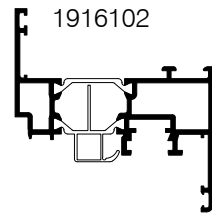
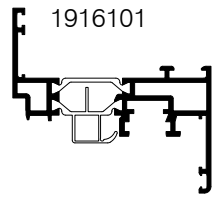

	(Pa) (m ²)**	800	1200	1600 (1.5)**	-	800	1200	1600 (1.7)**	1600 (1.7)**	800	1200	1600 (1.8)**	1600 (1.8)**	800	1200	1600 (2.0)**	-		
	(Pa)	150	300	600	-	150	300	600	600	150	300	600	600	150	300	600	-		
Flügelgröße Sash size	max.	FAB (m)	1.2	1.2	1.2	-	1.3	1.3	1.3	1.0	1.3	1.3	1.3	1.0	1.3	1.3	1.3	-	
		FAH (m)	1.7	1.6	1.5	-	1.9	1.8	1.7	2.25	2.0	1.9	1.7	2.25	2.25	2.25	2.25	-	
	min.	FAB (m)	0.425	0.425	0.425	-	0.425	0.425	0.425	0.425	0.425	0.425	0.425	0.425	0.425	0.425	0.425	0.425	-
		FAH (m)	0.72	0.72	0.72	-	0.72	0.72	0.72	0.72	0.72	0.72	0.72	0.72	0.72	0.72	0.72	0.72	-
MV / MB	FAB (m)	-	-	-	-	-	-	-	-	-	-	-	-	-	-	-	-	-	
	FAH (m)	1.5	1.5	1.3	-	1.7	1.6	1.5	1.5	1.8	1.7	1.6	1.5	1.8	1.7	1.6	-	-	
	min.	FAB (m)	-	-	-	-	-	-	-	-	-	-	-	-	-	-	-	-	
		FAH (m)	-	-	-	-	-	-	-	-	-	-	-	-	-	-	-	-	
	min.	FAB (m)	-	-	-	-	-	-	-	-	-	-	-	-	-	-	-	-	
		FAH (m)	-	-	-	-	-	-	-	-	-	-	-	-	-	-	-	-	
	max. (kg)	100 (Klotzabst. 50 mm zur Ecke) (Shim dist. to corner 50 mm)				160													

** Flügelgröße > () m² benötigt eine horizontale Zusatzverriegelung am Gehflügel
** Sash size > () m² requires a horizontal additional locking points in active leaf

WICLINE 65

Aufliegende Beschläge
Top mounted fittings

Zulässige Flügelgrößen
Admissible sash sizes



Profile
Profiles

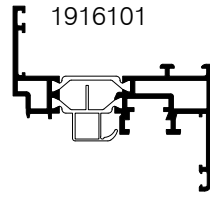

Profile
Profiles

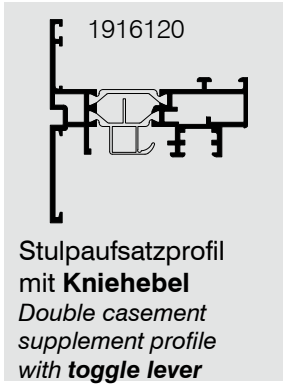
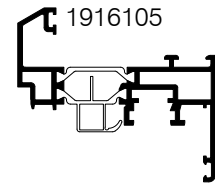

	(Pa)	800	1200	-	-	
	(Pa)	300	600	-	-	
Flügelgröße Sash size	max.	FAB (m)	1.2	1.2	-	-
		FAH (m)	1.6	1.5	-	-
	min.	FAB (m)	0.425	0.425	-	-
		FAH (m)	0.72	0.72	-	-
MV / MB	FAB (m)	-	-	-	-	
	FAH (m)	1.4	1.3	-	-	
	min.	FAB (m)	-	-	-	-
		FAH (m)	-	-	-	-
	min.	FAB (m)	-	-	-	-
		FAH (m)	-	-	-	-
	max. (kg)	100 (Klotzabst. 50 mm zur Ecke) (Shim dist. to corner 50 mm)				

	(Pa)	800	1200	-	-	
	(Pa)	300	600	-	-	
Flügelgröße Sash size	max.	FAB (m)	1.2	1.2	-	-
		FAH (m)	1.6	1.5	-	-
	min.	FAB (m)	0.425	0.425	-	-
		FAH (m)	0.72	0.72	-	-
MV / MB	FAB (m)	-	-	-	-	
	FAH (m)	1.4	1.3	-	-	
	min.	FAB (m)	-	-	-	-
		FAH (m)	-	-	-	-
	min.	FAB (m)	-	-	-	-
		FAH (m)	-	-	-	-
	max. (kg)	100 (Klotzabst. 50 mm zur Ecke) (Shim dist. to corner 50 mm)				

WICLINE 65

Aufliegende Beschläge
Top mounted fittings

Zulässige Flügelgrößen
Admissible sash sizes



Profile
Profiles

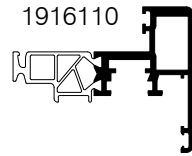

Profile
Profiles

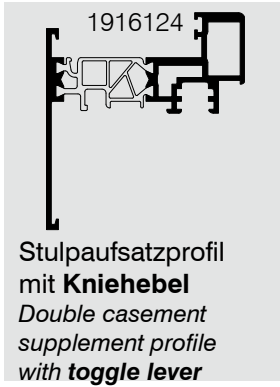
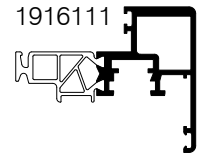

	(Pa)	400	800	1200	-	
	(Pa)	150	300	600	-	
Flügelgröße Sash size	max.	FAB (m)	1.2	1.1	1.0	-
		FAH (m)	1.4	1.4	1.3	-
	min.	FAB (m)	0.425	0.425	0.425	-
		FAH (m)	0.72	0.72	0.72	-
MV / MB		FAB (m)	-	-	-	-
		FAH (m)	1.3	1.2	1.1	-
	min.	FAB (m)	-	-	-	-
		FAH (m)	-	-	-	-
	min.	FAB (m)	-	-	-	-
		FAH (m)	-	-	-	-
	max.(kg)	80				

	(Pa)	400	800	1200	-	
	(Pa)	150	300	600	-	
Flügelgröße Sash size	max.	FAB (m)	1.3	1.2	1.1	-
		FAH (m)	1.6	1.6	1.5	-
	min.	FAB (m)	0.425	0.425	0.425	-
		FAH (m)	0.72	0.72	0.72	-
MV / MB	max.	FAB (m)	-	-	-	-
		FAH (m)	1.4	1.3	1.2	-
	min.	FAB (m)	-	-	-	-
		FAH (m)	-	-	-	-
	min.	FAB (m)	-	-	-	-
		FAH (m)	-	-	-	-
	max.(kg)	100				

WICLINE 65

Aufliegende Beschläge
Top mounted fittings

Zulässige Flügelgrößen
Admissible sash sizes



Profile Profiles		1916101				1916102				1916103				1916104				1916105				1916115				
	(Pa)	800	1200	2000	-	800	1200	2000	2000	800	1200	2000	2000*	800	1200	2000*	-	800	1200	2000	-	800	1200	2000	-	
	(Pa)	150	300	600	-	150	300	600	600	150	300	600	600	150	300	600	600	150	300	600	-	150	300	600	-	
Flügelgröße Sash size	max.	FAB (m)	1.3	1.2	1.1	-	1.6	1.5	1.4	1.0	1.6	1.6	1.5	1.0	1.7	1.7	1.6	-	1.7	1.7	1.6	-	1.7	1.7	1.6	-
		FAH (m)	1.7	1.7	1.7	-	2.0	2.0	2.0	2.25	2.25	2.25	2.25	2.5	2.5	2.5	2.5	-	2.5	2.5	2.5	-	2.5	2.5	2.5	-
	min.	FAB (m)	0.425	0.425	0.425	-	0.425	0.425	0.425	0.425	0.425	0.425	0.425	0.425	0.425	0.425	0.425	-	0.425	0.425	0.425	-	0.425	0.425	0.425	-
		FAH (m)	0.7	0.7	0.7	-	0.7	0.7	0.7	0.7	0.7	0.7	0.7	0.7	0.7	0.7	0.7	-	0.7	0.7	0.7	-	0.7	0.7	0.7	-
MV / MB	FAB (m)	-	-	-	-	-	-	1.3	-	-	-	1.3	-	-	-	1.3	-	-	-	1.3	-	-	-	1.3	-	
	FAH (m)	1.5	1.5	1.3	-	1.7	1.6	1.5	1.5	1.8	1.7	1.6	1.5*	1.8	1.7	1.6*	-	1.8	1.7	1.6*	-	1.8	1.7	1.6*	-	
	min.	FAB (m)	0.425	0.425	0.425	-	0.425	0.425	0.425	0.425	0.425	0.425	0.425	0.425	0.425	0.425	0.425	-	0.425	0.425	0.425	-	0.425	0.425	0.425	-
		FAH (m)	0.7	0.7	0.7	-	0.7	0.7	0.7	0.7	0.7	0.7	0.7	0.7	0.7	0.7	0.7	-	0.7	0.7	0.7	-	0.7	0.7	0.7	-
	min.	FAB (m)	0.68	0.68	0.68	-	0.68	0.68	0.68	0.68	0.68	0.68	0.68	0.68	0.68	0.68	0.68	-	0.68	0.68	0.68	-	0.68	0.68	0.68	-
		FAH (m)	0.9	0.9	0.9	-	0.9	0.9	0.9	0.9	0.9	0.9	0.9	0.9	0.9	0.9	0.9	-	0.9	0.9	0.9	-	0.9	0.9	0.9	-
	max. (kg)	100 (Klotzabst. 50 mm zur Ecke) (Shim dist. to corner 50 mm)				130				130				130												





* Windlast > 1600 Pa und FAH > 2.25 m werden zwei vertikale Zusatzverriegelungen benötigt
* Wind load > 1600 Pa and FAH > 2.25 m requires two vertical additional locking points

WICLINE 65

Aufliegende Beschläge
Top mounted fittings

Zulässige Flügelgrößen
Admissible sash sizes



Profile Profiles		1916110				1916111				1916112				1916113				
	(Pa)	800	1200	2000	-	800	1200	2000	-	800	1200	2000	-	800	1200	2000	-	
	(Pa)	150	300	600	-	150	300	600	-	150	300	600	-	150	300	600	-	
Flügelgröße Sash size	max.	FAB (m)	1.2	1.1	1.0	-	1.3	1.2	1.1	-	1.4	1.3	1.2	-	1.4	1.4	1.3	-
		FAH (m)	1.4	1.4	1.4	-	1.6	1.6	1.6	-	1.7	1.7	1.7	-	1.8	1.8	1.8	-
	min.	FAB (m)	0.425	0.425	0.425	-	0.425	0.425	0.425	-	0.425	0.425	0.425	-	0.425	0.425	0.425	-
		FAH (m)	0.7	0.7	0.7	-	0.7	0.7	0.7	-	0.7	0.7	0.7	-	0.7	0.7	0.7	-
MV / MB	FAB (m)	-	-	-	-	-	-	-	-	-	-	-	-	-	-	-	-	
	FAH (m)	1.3	1.2	1.1	-	1.4	1.3	1.2	-	1.5	1.4	1.3	-	1.5	1.5	1.4	-	
	min.	FAB (m)	0.425	0.425	0.425	-	0.425	0.425	0.425	-	0.425	0.425	0.425	-	0.425	0.425	0.425	-
		FAH (m)	0.7	0.7	0.7	-	0.7	0.7	0.7	-	0.7	0.7	0.7	-	0.7	0.7	0.7	-
	min.	FAB (m)	0.68	0.68	0.68	-	0.68	0.68	0.68	-	0.68	0.68	0.68	-	0.68	0.68	0.68	-
		FAH (m)	0.9	0.9	0.9	-	0.9	0.9	0.9	-	0.9	0.9	0.9	-	0.9	0.9	0.9	-
	max.(kg)	80				100				100				100				

WICLINE 65

Aufliegende Beschläge
Top mounted fittings

Zulässige Flügelgrößen
Admissible sash sizes



Profile Profiles		1916112				1916113															
		(Pa)	800	1200	2000	-	800	1200	2000	-											
		(Pa)	150	300	600	-	150	300	600	-											
Flügelgröße Sash size	max.	FAB (m)	1.4	1.3	1.2	-	1.4	1.4	1.3	-											
		FAH (m)	1.8	2.0	2.1	-	2.0	2.0	2.25	-											
	min.	FAB (m)	0.425	0.425	0.425	-	0.425	0.425	0.425	-											
		FAH (m)	0.7	0.7	0.7	-	0.7	0.7	0.7	-											
MV / MB	FAB (m)	-	-	-	-	-	-	-	-												
	FAH (m)	1.5	1.4	1.3	-	1.5	1.5	1.4	-												
	min.	FAB (m)	0.425	0.425	0.425	-	0.425	0.425	0.425	-											
		FAH (m)	0.7	0.7	0.7	-	0.7	0.7	0.7	-											
	min.	FAB (m)	0.68	0.68	0.68	-	0.68	0.68	0.68	-											
		FAH (m)	0.9	0.9	0.9	-	0.9	0.9	0.9	-											
	max.	max. (kg)	130***				130***														

*** Zusätzliche Verklebung, Angaben in den Verarbeitungsrichtlinien beachten!
*** Additional gluing, pay attention to specifications in the workshop manual!

WICLINE 65

Aufliegende Beschläge
Top mounted fittings

Zulässige Flügelgrößen
Admissible sash sizes



Profile Profiles		1916101				1916102				1916103				1916104				1916105				1916115				
	(Pa)	800	1200	2000	-	800	1200	2000	2000	800	1200	2000	2000*	800	1200	2000*	-	800	1200	2000	-	800	1200	2000	-	
	(Pa)	150	300	600	-	150	300	600	600	150	300	600	600	150	300	600	600	150	300	600	-	150	300	600	-	
Flügelgröße Sash size	max.	FAB (m)	1.7	1.7	1.7	-	2.0	2.0	2.0	2.25	2.25	2.25	2.25	2.5	2.5	2.5	2.5	-	2.5	2.5	2.5	-	2.5	2.5	2.5	-
		FAH (m)	1.3	1.2	1.1	-	1.6	1.5	1.4	1.0	1.6	1.6	1.5	1.0	1.7	1.7	1.6	-	1.7	1.7	1.6	-	1.6	1.6	1.6	-
	min.	FAB (m)	0.6	0.6	0.6	-	0.6	0.6	0.6	0.6	0.6	0.6	0.6	0.6	0.6	0.6	0.6	-	0.6	0.6	0.6	-	0.6	0.6	0.6	-
		FAH (m)	0.425	0.425	0.425	-	0.425	0.425	0.425	0.425	0.425	0.425	0.425	0.425	0.425	0.425	0.425	-	0.425	0.425	0.425	-	0.425	0.425	0.425	-
MV / MB	FAB (m)	1.5	1.5	1.3	-	1.7	1.6	1.5	1.5	1.8	1.7	1.6	1.5*	1.8	1.7	1.6*	-	1.8	1.7	1.6*	-	1.8	1.7	1.6*	-	
	FAH (m)	-	-	-	-	-	-	1.3	-	-	-	1.3	-	-	-	1.3	-	-	-	1.3	-	-	-	1.3	-	
	min.	FAB (m)	0.74	0.74	0.74	-	0.74	0.74	0.74	0.74	0.74	0.74	0.74	0.74	0.74	0.74	0.74	-	0.74	0.74	0.74	-	0.74	0.74	0.74	-
		FAH (m)	0.425	0.425	0.425	-	0.425	0.425	0.425	0.425	0.425	0.425	0.425	0.425	0.425	0.425	0.425	-	0.425	0.425	0.425	-	0.425	0.425	0.425	-
	min.	FAB (m)	0.9	0.9	0.9	-	0.9	0.9	0.9	0.9	0.9	0.9	0.9	0.9	0.9	0.9	0.9	-	0.9	0.9	0.9	-	0.9	0.9	0.9	-
		FAH (m)	0.6	0.6	0.6	-	0.6	0.6	0.6	0.6	0.6	0.6	0.6	0.6	0.6	0.6	0.6	-	0.6	0.6	0.6	-	0.6	0.6	0.6	-
	max. (kg)	100 (Klotzabst. 50 mm zur Ecke) (Shim dist. to corner 50 mm)				130				130				130												





* Windlast > 1600 Pa und FAB > 2.25 m werden zwei horizontale Zusatzverriegelungen benötigt
* Wind load > 1600 Pa and FAB > 2.25 m requires two horizontal additional locking points

WICLINE 65

Aufliegende Beschläge
Top mounted fittings

Zulässige Flügelgrößen
Admissible sash sizes

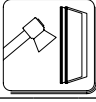





Profile Profiles		1916110				1916111				1916112				1916113				
	(Pa)	800	1200	2000	-	800	1200	2000	-	800	1200	2000	-	800	1200	2000	-	
	(Pa)	150	300	600	-	150	300	600	-	150	300	600	-	150	300	600	-	
Flügelgröße Sash size	max.	FAB (m)	1.4	1.4	1.4	-	1.6	1.6	1.6	-	1.7	1.7	1.7	-	1.8	1.8	1.8	-
		FAH (m)	1.2	1.1	1.0	-	1.3	1.2	1.1	-	1.4	1.3	1.2	-	1.4	1.4	1.3	-
	min.	FAB (m)	0.6	0.6	0.6	-	0.6	0.6	0.6	-	0.6	0.6	0.6	-	0.6	0.6	0.6	-
		FAH (m)	0.425	0.425	0.425	-	0.425	0.425	0.425	-	0.425	0.425	0.425	-	0.425	0.425	0.425	-
MV / MB	FAB (m)	1.3	1.2	1.1	-	1.4	1.3	1.2	-	1.5	1.4	1.3	-	1.5	1.5	1.4	-	
	FAH (m)	-	-	-	-	-	-	-	-	-	-	-	-	-	-	-	-	
	min.	FAB (m)	0.74	0.74	0.74	-	0.74	0.74	0.74	-	0.74	0.74	0.74	-	0.74	0.74	0.74	-
		FAH (m)	0.425	0.425	0.425	-	0.425	0.425	0.425	-	0.425	0.425	0.425	-	0.425	0.425	0.425	-
	min.	FAB (m)	0.9	0.9	0.9	-	0.9	0.9	0.9	-	0.9	0.9	0.9	-	0.9	0.9	0.9	-
		FAH (m)	0.6	0.6	0.6	-	0.6	0.6	0.6	-	0.6	0.6	0.6	-	0.6	0.6	0.6	-
	max.(kg)	80				100				100				100				

WICLINE 65

Aufliegende Beschläge
Top mounted fittings

Zulässige Flügelgrößen
Admissible sash sizes

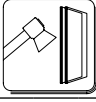

Profile Profiles		1916112				1916113													
	(Pa)	800	1200	2000	-	800	1200	2000	-										
	(Pa)	150	300	600	-	150	300	600	-										
Flügelgröße Sash size	max.	FAB (m)	1.8	2.0	2.1	-	2.0	2.0	2.25	-									
		FAH (m)	1.4	1.3	1.2	-	1.4	1.4	1.3	-									
	min.	FAB (m)	0.6	0.6	0.6	-	0.6	0.6	0.6	-									
		FAH (m)	0.425	0.425	0.425	-	0.425	0.425	0.425	-									
MV / MB	FAB (m)	1.5	1.4	1.3	-	1.5	1.5	1.4	-										
	FAH (m)	-	-	-	-	-	-	-	-										
	min.	FAB (m)	0.74	0.74	0.74	-	0.74	0.74	0.74	-									
		FAH (m)	0.425	0.425	0.425	-	0.425	0.425	0.425	-									
	min.	FAB (m)	0.9	0.9	0.9	-	0.9	0.9	0.9	-									
		FAH (m)	0.6	0.6	0.6	-	0.6	0.6	0.6	-									
	max. (kg)	130***				130***													

*** Zusätzliche Verklebung, Angaben in den Verarbeitungsrichtlinien beachten!
*** Additional gluing, pay attention to specifications in the workshop manual!

WICLINE 65

Aufliegende Beschläge
Top mounted fittings

Zulässige Flügelgrößen
Admissible sash sizes



Profile Profiles		1916101				1916102				1916103				1916104				1916105				1916115					
	(Pa)	800	1200	2000	-	800	1200	2000	2000	800	1200	2000	2000*	800	1200	2000*	-	800	1200	2000	-	800	1200	2000	-		
	(Pa)	150	300	600	-	150	300	600	600	150	300	600	600	150	300	600	600	150	300	600	-	150	300	600	-		
Flügelgröße Sash size	max.	FAB (m)	1.7	1.7	1.7	-	2.0	2.0	2.0	2.25	2.25	2.25	2.25	2.5	2.5	2.5	2.5	2.5	-	2.5	2.5	2.5	-	2.5	2.5	2.5	-
		FAH (m)	1.3	1.2	1.1	-	1.6	1.5	1.4	1.0	1.6	1.6	1.5	1.0	1.7	1.7	1.6	-	1.7	1.7	1.6	-	1.6	1.6	1.6	-	
	min.	FAB (m)	0.55	0.55	0.55	-	0.55	0.55	0.55	0.55	0.55	0.55	0.55	0.55	0.55	0.55	0.55	0.55	-	0.55	0.55	0.55	-	0.55	0.55	0.55	-
		FAH (m)	0.425	0.425	0.425	-	0.425	0.425	0.425	0.425	0.425	0.425	0.425	0.425	0.425	0.425	0.425	0.425	-	0.425	0.425	0.425	-	0.425	0.425	0.425	-
MV / MB	FAB (m)	1.5	1.5	1.3	-	1.7	1.6	1.5	1.5	1.8	1.7	1.6	1.5*	1.8	1.7	1.6*	-	1.8	1.7	1.6*	-	1.8	1.7	1.6*	-		
	FAH (m)	-	-	-	-	-	-	1.3	-	-	-	1.3	-	-	-	1.3	-	-	-	1.3	-	-	-	1.3	-		
	min.	FAB (m)	0.88	0.88	0.88	-	0.88	0.88	0.88	0.88	0.88	0.88	0.88	0.88	0.88	0.88	0.88	0.88	-	0.88	0.88	0.88	-	0.88	0.88	0.88	-
		FAH (m)	0.425	0.425	0.425	-	0.425	0.425	0.425	0.425	0.425	0.425	0.425	0.425	0.425	0.425	0.425	0.425	-	0.425	0.425	0.425	-	0.425	0.425	0.425	-
	min.	FAB (m)	0.88	0.88	0.88	-	0.88	0.88	0.88	0.88	0.88	0.88	0.88	0.88	0.88	0.88	0.88	0.88	-	0.88	0.88	0.88	-	0.88	0.88	0.88	-
		FAH (m)	0.6	0.6	0.6	-	0.6	0.6	0.6	0.6	0.6	0.6	0.6	0.6	0.6	0.6	0.6	0.6	-	0.6	0.6	0.6	-	0.6	0.6	0.6	-
	max. (kg)	80 (Klotzabst. 50 mm zur Ecke) (Shim dist. to corner 50 mm)				80 / 120																					

* Windlast > 1600 Pa und FAB > 2.25 m werden zwei horizontale Zusatzverriegelungen/Mittelbänder benötigt
* Wind load > 1600 Pa and FAB 2.25 m requires two horizontal additional locking points/centre hinges

WICLINE 65

Aufliegende Beschläge
Top mounted fittings

Zulässige Flügelgrößen
Admissible sash sizes



Profile Profiles		1916110				1916111				1916112				1916113				
	(Pa)	800	1200	2000	-	800	1200	2000	-	800	1200	2000	-	800	1200	2000	-	
	(Pa)	150	300	600	-	150	300	600	-	150	300	600	-	150	300	600	-	
Flügelgröße Sash size	max.	FAB (m)	1.4	1.4	1.4	-	1.6	1.6	1.6	-	1.7	1.7	1.7	-	1.8	1.8	1.8	-
		FAH (m)	1.2	1.1	1.0	-	1.3	1.2	1.1	-	1.4	1.3	1.2	-	1.4	1.4	1.3	-
	min.	FAB (m)	0.55	0.55	0.55	-	0.55	0.55	0.55	-	0.55	0.55	0.55	-	0.55	0.55	0.55	-
		FAH (m)	0.425	0.425	0.425	-	0.425	0.425	0.425	-	0.425	0.425	0.425	-	0.425	0.425	0.425	-
MV / MB	FAB (m)	1.3	1.2	1.1	-	1.4	1.3	1.2	-	1.5	1.4	1.3	-	1.5	1.5	1.4	-	
	FAH (m)	-	-	-	-	-	-	-	-	-	-	-	-	-	-	-	-	
	min.	FAB (m)	0.88	0.88	0.88	-	0.88	0.88	0.88	-	0.88	0.88	0.88	-	0.88	0.88	0.88	-
		FAH (m)	0.425	0.425	0.425	-	0.425	0.425	0.425	-	0.425	0.425	0.425	-	0.425	0.425	0.425	-
	min.	FAB (m)	0.88	0.88	0.88	-	0.88	0.88	0.88	-	0.88	0.88	0.88	-	0.88	0.88	0.88	-
		FAH (m)	0.6	0.6	0.6	-	0.6	0.6	0.6	-	0.6	0.6	0.6	-	0.6	0.6	0.6	-
	max. (kg)	80				80				80				80				

WICLINE 65

Aufliegende Beschläge
Top mounted fittings

Zulässige Flügelgrößen
Admissible sash sizes



Profile Profiles		1916112				1916113													
	(Pa)	800	1200	2000	-	800	1200	2000	-										
	(Pa)	150	300	600	-	150	300	600	-										
Flügelgröße Sash size	max.	FAB (m)	1.8	2.0	2.1	-	2.0	2.0	2.25	-									
		FAH (m)	1.4	1.3	1.2	-	1.4	1.4	1.3	-									
	min.	FAB (m)	0.55	0.55	0.55	-	0.55	0.55	0.55	-									
		FAH (m)	0.425	0.425	0.425	-	0.425	0.425	0.425	-									
MV / MB	FAB (m)	1.5	1.4	1.3	-	1.5	1.5	1.4	-										
	FAH (m)	-	-	-	-	-	-	-	-										
	min.	FAB (m)	0.88	0.88	0.88	-	0.88	0.88	0.88	-									
		FAH (m)	0.425	0.425	0.425	-	0.425	0.425	0.425	-									
	min.	FAB (m)	0.88	0.88	0.88	-	0.88	0.88	0.88	-									
		FAH (m)	0.6	0.6	0.6	-	0.6	0.6	0.6	-									
	max. (kg)	80 / 120***				80 / 120***													

*** Zusätzliche Verklebung, Angaben in den Verarbeitungsrichtlinien beachten!
*** Additional gluing, pay attention to specifications in the workshop manual!

WICLINE 65

Verdeckte Beschläge
Concealed fittings



Zulässige Flügelgrößen
Admissible sash sizes



Profile Profiles		1916101				1916102				1916103				1916104				1916105				1916115				
	(Pa)	800	1200	2000	-	800	1200	2000	2000	800	1200	2000	2000*	800	1200	2000*	-	800	1200	2000	-	800	1200	2000	-	
	(Pa)	150	300	600	-	150	300	600	600	150	300	600	600	150	300	600	600	150	300	600	-	150	300	600	-	
Flügelgröße Sash size	max.	FAB (m)	1.3	1.2	1.1	-	1.6	1.5	1.4	1.0	1.6	1.6	1.5	1.0	1.7	1.7	1.6	-	1.7	1.7	1.6	-	1.7	1.7	1.6	-
		FAH (m)	1.7	1.7	1.7	-	2.0	2.0	2.0	2.25	2.25	2.25	2.25	2.5	2.5	2.5	2.5	-	2.5	2.5	2.5	-	2.5	2.5	2.5	-
	min.	FAB (m)	0.45	0.45	0.45	-	0.45	0.45	0.45	0.45	0.45	0.45	0.45	0.45	0.45	0.45	0.45	-	0.45	0.45	0.45	-	0.45	0.45	0.45	-
		FAH (m)	0.6	0.6	0.6	-	0.6	0.6	0.6	0.6	0.6	0.6	0.6	0.6	0.6	0.6	0.6	-	0.6	0.6	0.6	-	0.6	0.6	0.6	-
MV / MB	FAB (m)	-	-	-	-	-	-	1.3	-	-	-	1.3	-	-	-	1.3	-	-	-	1.3	-	-	-	1.3	-	
	FAH (m)	1.5	1.5	1.3	-	1.7	1.6	1.5	1.5	1.8	1.7	1.6	1.5*	1.8	1.7	1.6*	-	1.8	1.7	1.6*	-	1.8	1.7	1.6*	-	
	min.	FAB (m)	0.45	0.45	0.45	-	0.45	0.45	0.45	0.45	0.45	0.45	0.45	0.45	0.45	0.45	0.45	-	0.45	0.45	0.45	-	0.45	0.45	0.45	-
		FAH (m)	0.83	0.83	0.83	-	0.83	0.83	0.83	0.83	0.83	0.83	0.83	0.83	0.83	0.83	0.83	-	0.83	0.83	0.83	-	0.83	0.83	0.83	-
	min.	FAB (m)	0.65	0.65	0.65	-	0.65	0.65	0.65	0.65	0.65	0.65	0.65	0.65	0.65	0.65	0.65	-	0.65	0.65	0.65	-	0.65	0.65	0.65	-
		FAH (m)	0.9	0.9	0.9	-	0.9	0.9	0.9	0.9	0.9	0.9	0.9	0.9	0.9	0.9	0.9	-	0.9	0.9	0.9	-	0.9	0.9	0.9	-
	max. (kg)	100 (Klotzabst. 50 mm zur Ecke) (Shim dist. to corner 50 mm)				160																				

* Windlast > 1600 Pa und FAH > 2.25 m werden zwei vertikale Zusatzverriegelungen benötigt
* Wind load > 1600 Pa and FAH 2.25 m requires two vertical additional locking points

WICLINE 65

Verdeckte Beschläge
Concealed fittings



Zulässige Flügelgrößen
Admissible sash sizes



Profile Profiles		1916110				1916111				1916112				1916113				
	(Pa)	800	1200	2000	-	800	1200	2000	-	800	1200	2000	-	800	1200	2000	-	
	(Pa)	150	300	600	-	150	300	600	-	150	300	600	-	150	300	600	-	
Flügelgröße Sash size	max.	FAB (m)	1.2	1.1	1.0	-	1.3	1.2	1.1	-	1.4	1.3	1.2	-	1.4	1.4	1.3	-
		FAH (m)	1.4	1.4	1.4	-	1.6	1.6	1.6	-	1.7	1.7	1.7	-	1.8	1.8	1.8	-
	min.	FAB (m)	0.45	0.45	0.45	-	0.45	0.45	0.45	-	0.45	0.45	0.45	-	0.45	0.45	0.45	-
		FAH (m)	0.6	0.6	0.6	-	0.6	0.6	0.6	-	0.6	0.6	0.6	-	0.6	0.6	0.6	-
MV / MB	FAB (m)	-	-	-	-	-	-	-	-	-	-	-	-	-	-	-	-	
	FAH (m)	1.3	1.2	1.1	-	1.4	1.3	1.2	-	1.5	1.4	1.3	-	1.5	1.5	1.4	-	
	min.	FAB (m)	0.45	0.45	0.45	-	0.45	0.45	0.45	-	0.45	0.45	0.45	-	0.45	0.45	0.45	-
		FAH (m)	0.83	0.83	0.83	-	0.83	0.83	0.83	-	0.83	0.83	0.83	-	0.83	0.83	0.83	-
	min.	FAB (m)	0.65	0.65	0.65	-	0.65	0.65	0.65	-	0.65	0.65	0.65	-	0.65	0.65	0.65	-
		FAH (m)	0.9	0.9	0.9	-	0.9	0.9	0.9	-	0.9	0.9	0.9	-	0.9	0.9	0.9	-
	max.(kg)	80				100				100				100				

6

WICLINE 65

Verdeckte Beschläge
Concealed fittings



Zulässige Flügelgrößen
Admissible sash sizes



Profile Profiles		1916112				1916113												
		(Pa)	800	1200	2000	-	800	1200	2000	-								
		(Pa)	150	300	600	-	150	300	600	-								
Flügelgröße Sash size	max.	FAB (m)	1.4	1.3	1.2	-	1.4	1.4	1.3	-								
		FAH (m)	1.8	2.0	2.1	-	2.0	2.0	2.25	-								
	min.	FAB (m)	0.45	0.45	0.45	-	0.45	0.45	0.45	-								
		FAH (m)	0.6	0.6	0.6	-	0.6	0.6	0.6	-								
MV / MB	FAB (m)	-	-	-	-	-	-	-	-									
	FAH (m)	1.5	1.4	1.3	-	1.5	1.5	1.4	-									
	min.	FAB (m)	0.45	0.45	0.45	-	0.45	0.45	0.45	-								
		FAH (m)	0.83	0.83	0.83	-	0.83	0.83	0.83	-								
	min.	FAB (m)	0.65	0.65	0.65	-	0.65	0.65	0.65	-								
		FAH (m)	0.9	0.9	0.9	-	0.9	0.9	0.9	-								
	max. (kg)		130***				130***											

*** Zusätzliche Verklebung, Angaben in den Verarbeitungsrichtlinien beachten!
*** Additional gluing, pay attention to specifications in the workshop manual!

WICLINE 65

Verdeckte Beschläge
Concealed fittings



Zulässige Flügelgrößen
Admissible sash sizes



Profile
Profiles

1916121

Stulpaufsatzprofil mit **Stulpgetriebe**
Double casement supplement profile with **double casement gear**

1916101	1916102	1916103	1916104
1916105			1916115

	(Pa)	800	1200	1600 (1.5)**	-	800	1200	1600 (1.7)**	1600 (1.7)**	800	1200	1600 (1.8)**	1600* (1.8)**	800	1200	1600* (2.0)**	-		
		(Pa)	150	300	600	-	150	300	600	600	150	300	600	600	150	300	450	-	
Flügelgröße Sash size	max.	FAB (m)	1.3	1.2	1.1	-	1.6	1.5	1.4	1.0	1.6	1.6	1.5	1.0	1.7	1.7	1.6	-	
		FAH (m)	1.7	1.7	1.7	-	2.0	2.0	2.0	2.25	2.25	2.25	2.25	2.5	2.5	2.5	2.5	-	
	min.	FAB (m)	0.45	0.45	0.45	-	0.45	0.45	0.45	0.45	0.45	0.45	0.45	0.45	0.45	0.45	0.45	0.45	-
		FAH (m)	0.68	0.68	0.68	-	0.68	0.68	0.68	0.68	0.68	0.68	0.68	0.68	0.68	0.68	0.68	0.68	-
MV / MB	FAB (m)	-	-	-	-	-	-	1.3	-	1.3	1.3	1.3	-	1.3	1.3	1.3	-		
	FAH (m)	1.5	1.5	1.3	-	1.7	1.6	1.5	1.5	1.8	1.7	1.6	1.5*	1.8	1.7	1.6*	-		
	min.	FAB (m)	0.65	0.65	0.65	-	0.65	0.65	0.65	0.65	0.65	0.65	0.65	0.65	0.65	0.65	0.65	-	
		FAH (m)	1.05	1.05	1.05	-	1.05	1.05	1.05	1.05	1.05	1.05	1.05	1.05	1.05	1.05	1.05	1.05	-
	min.	FAB (m)	0.65	0.65	0.65	-	0.65	0.65	0.65	0.65	0.65	0.65	0.65	0.65	0.65	0.65	0.65	-	
		FAH (m)	1.12	1.12	1.12	-	1.12	1.12	1.12	1.12	1.12	1.12	1.12	1.12	1.12	1.12	1.12	1.12	-
	max. (kg)	100 (Klotzabst. 50 mm zur Ecke) (Shim dist. to corner 50 mm)				160													

* Windlast > 1200 Pa und FAH > 2.25 m werden zwei vertikale Zusatzverriegelungen benötigt
* Wind load > 1200 Pa and FAH > 2.25 m requires two vertical additional locking points

** Flügelgröße > () m² benötigt eine horizontale Zusatzverriegelung
** Sash size > () m² requires a horizontal additional locking points

WICLINE 65

Verdeckte Beschläge
Concealed fittings



Zulässige Flügelgrößen
Admissible sash sizes



Profile
Profiles

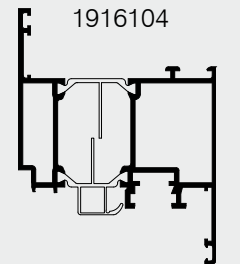
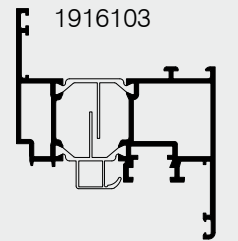
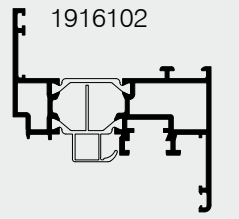
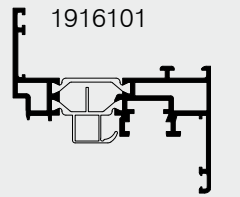

1916121

Stulpaufsatzprofil mit **Kniehebel**
Double casement supplement profile with **toggle lever**

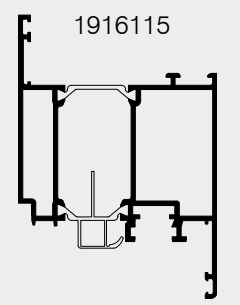
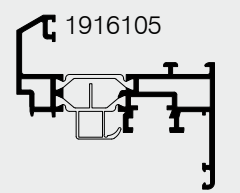

	(Pa) (m ²)**	800	1200	1600 (1.5)**	-	800	1200	1600 (1.7)**	1600 (1.7)**	800	1200	1600 (1.8)**	1600 (1.8)**	800	1200	1600 (2.0)**	-		
	(Pa)	150	300	600	-	150	300	600	600	150	300	600	600	150	300	600	-		
Flügelgröße Sash size	max.	FAB (m)	1.2	1.2	1.2	-	1.3	1.3	1.3	1.0	1.3	1.3	1.3	1.0	1.3	1.3	1.3	-	
		FAH (m)	1.7	1.6	1.5	-	1.9	1.8	1.7	2.25	2.0	1.9	1.7	2.25	2.25	2.25	2.25	-	
	min.	FAB (m)	0.45	0.45	0.45	-	0.45	0.45	0.45	0.45	0.45	0.45	0.45	0.45	0.45	0.45	0.45	0.45	-
		FAH (m)	0.72	0.72	0.72	-	0.72	0.72	0.72	0.72	0.72	0.72	0.72	0.72	0.72	0.72	0.72	0.72	-
MV / MB	FAB (m)	-	-	-	-	-	-	-	-	-	-	-	-	-	-	-	-	-	
	FAH (m)	1.5	1.5	1.3	-	1.7	1.6	1.5	1.5	1.8	1.7	1.6	1.5	1.8	1.7	1.6	1.6	-	
	min.	FAB (m)	-	-	-	-	-	-	-	-	-	-	-	-	-	-	-	-	
		FAH (m)	-	-	-	-	-	-	-	-	-	-	-	-	-	-	-	-	
	min.	FAB (m)	-	-	-	-	-	-	-	-	-	-	-	-	-	-	-	-	
		FAH (m)	-	-	-	-	-	-	-	-	-	-	-	-	-	-	-	-	
	max. (kg)	100 (Klotzabst. 50 mm zur Ecke) (Shim dist. to corner 50 mm)				160													

** Flügelgröße > () m² benötigt eine horizontale Zusatzverriegelung am Gehflügel
** Sash size > () m² requires a horizontal additional locking points in active leaf

WICLINE 65

Verdeckte Beschläge
Concealed fittings



Zulässige Flügelgrößen Admissible sash sizes



Profile
Profiles

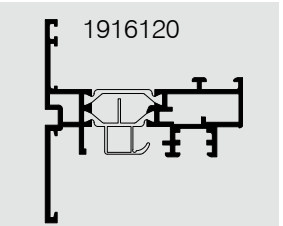
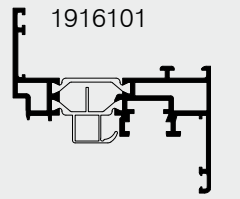

Stulpaufsatzprofil
mit **Kniehebel**
Double casement
supplement profile
with **toggle lever**

	(Pa)	800	1200	-	-	
	(Pa)	300	600	-	-	
Flügelgröße Sash size	max.	FAB (m)	1.2	1.2	-	-
		FAH (m)	1.6	1.5	-	-
	min.	FAB (m)	0.45	0.45	-	-
		FAH (m)	0.72	0.72	-	-
MV / MB	FAB (m)	-	-	-	-	
	FAH (m)	1.4	1.3	-	-	
	min.	FAB (m)	-	-	-	-
		FAH (m)	-	-	-	-
	min.	FAB (m)	-	-	-	-
		FAH (m)	-	-	-	-
	max. (kg)	100 (Klotzabst. 50 mm zur Ecke) (Shim dist. to corner 50 mm)				

Profile
Profiles

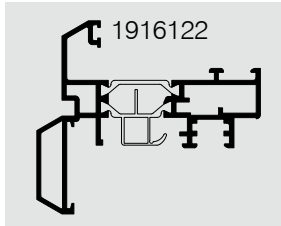
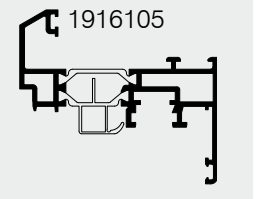

Stulpaufsatzprofil
mit **Kniehebel**
Double casement
supplement profile
with **toggle lever**

	(Pa)	800	1200	-	-	
	(Pa)	300	600	-	-	
Flügelgröße Sash size	max.	FAB (m)	1.2	1.2	-	-
		FAH (m)	1.6	1.5	-	-
	min.	FAB (m)	0.45	0.45	-	-
		FAH (m)	0.72	0.72	-	-
MV / MB	FAB (m)	-	-	-	-	
	FAH (m)	1.4	1.3	-	-	
	min.	FAB (m)	-	-	-	-
		FAH (m)	-	-	-	-
	min.	FAB (m)	-	-	-	-
		FAH (m)	-	-	-	-
	max. (kg)	100 (Klotzabst. 50 mm zur Ecke) (Shim dist. to corner 50 mm)				

6

WICLINE 65

Verdeckte Beschläge
Concealed fittings



Zulässige Flügelgrößen Admissible sash sizes



Profile
Profiles

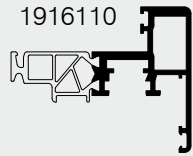

1916110

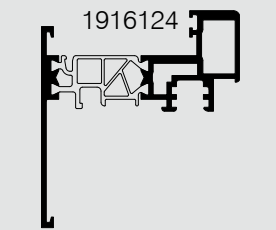

1916124

Stulpaufsatzprofil
mit **Kniehebel**
Double casement
supplement profile
with **toggle lever**



(Pa)

400

800

1200

-



(Pa)

150

300

600

-

Flügelgröße
Sash size

max.

FAB (m)

1.2

1.1

1.0

-

FAH (m)

1.4

1.4

1.3

-

min.

FAB (m)

0.45

0.45

0.45

-

FAH (m)

0.72

0.72

0.72

-

MV / MB

FAB (m)

-

-

-

-

FAH (m)

1.3

1.2

1.1

-

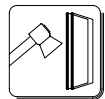

min.

FAB (m)

-

-

-

-

FAH (m)

-

-

-

-

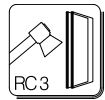

min.

FAB (m)

-

-

-

-

FAH (m)

-

-

-

-



max.(kg)

80

Profile
Profiles

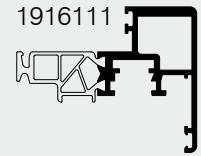

1916111

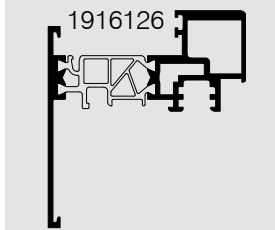

1916126

Stulpaufsatzprofil
mit **Kniehebel**
Double casement
supplement profile
with **toggle lever**



(Pa)

400

800

1200

-



(Pa)

150

300

600

-

Flügelgröße
Sash size

max.

FAB (m)

1.3

1.2

1.1

-

FAH (m)

1.6

1.6

1.5

-

min.

FAB (m)

0.45

0.45

0.45

-

FAH (m)

0.72

0.72

0.72

-

MV / MB

FAB (m)

-

-

-

-

FAH (m)

1.4

1.3

1.2

-

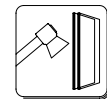

min.

FAB (m)

-

-

-

-

FAH (m)

-

-

-

-

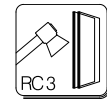

min.

FAB (m)

-

-

-

-

FAH (m)

-

-

-

-



max.(kg)

100

WICLINE 65

Verdeckte Beschläge
Concealed fittings



Zulässige Flügelgrößen
Admissible sash sizes



Profile
Profiles

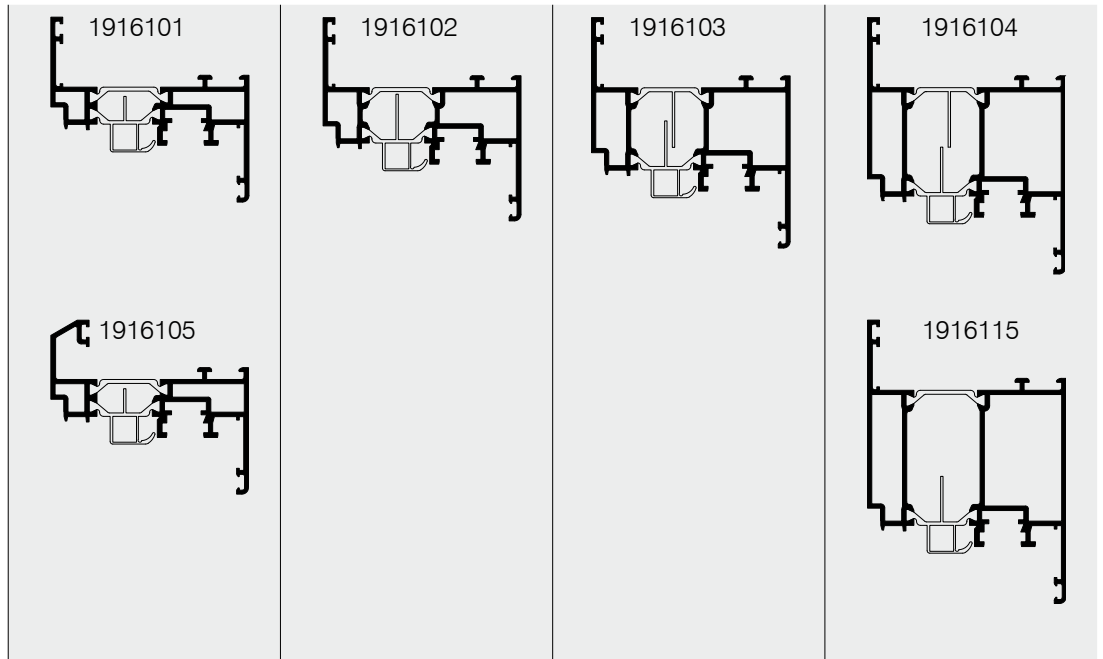

	(Pa)	800	1200	2000	-	800	1200	2000	2000	800	1200	2000	2000*	800	1200	2000*	-		
	(Pa)	150	300	600	-	150	300	600	600	150	300	600	600	150	300	600	-		
Flügelgröße Sash size	max.	FAB (m)	1.3	1.2	1.1	-	1.6	1.5	1.4	1.0	1.6	1.6	1.5	1.0	1.7	1.7	1.6	-	
		FAH (m)	1.7	1.7	1.7	-	2.0	2.0	2.0	2.25	2.25	2.25	2.25	2.5	2.5	2.5	2.5	-	
	min.	FAB (m)	0.425	0.425	0.425	-	0.425	0.425	0.425	0.425	0.425	0.425	0.425	0.425	0.425	0.425	0.425	0.425	-
		FAH (m)	0.7	0.7	0.7	-	0.7	0.7	0.7	0.7	0.7	0.7	0.7	0.7	0.7	0.7	0.7	0.7	-
MV / MB	FAB (m)	-	-	-	-	-	-	1.3	-	-	-	1.3	-	-	-	1.3	-		
	FAH (m)	1.5	1.5	1.3	-	1.7	1.6	1.5	1.5	1.8	1.7	1.6	1.5*	1.8	1.7	1.6*	-		
	min.	FAB (m)	0.425	0.425	0.425	-	0.425	0.425	0.425	0.425	0.425	0.425	0.425	0.425	0.425	0.425	0.425	-	
		FAH (m)	0.7	0.7	0.7	-	0.7	0.7	0.7	0.7	0.7	0.7	0.7	0.7	0.7	0.7	0.7	-	
	min.	FAB (m)	0.68	0.68	0.68	-	0.68	0.68	0.68	0.68	0.68	0.68	0.68	0.68	0.68	0.68	0.68	-	
		FAH (m)	0.9	0.9	0.9	-	0.9	0.9	0.9	0.9	0.9	0.9	0.9	0.9	0.9	0.9	0.9	-	
	max. (kg)	100 (Klotzabst. 50 mm zur Ecke) (Shim dist. to corner 50 mm)				130				130				130					

* Windlast > 1600 Pa und FAH > 2.25 m werden zwei vertikale Zusatzverriegelungen benötigt
* Wind load > 1600 Pa and FAH > 2.25 m requires two vertical additional locking points





WICLINE 65

Verdeckte Beschläge
Concealed fittings



Zulässige Flügelgrößen
Admissible sash sizes

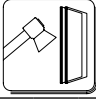

Profile Profiles		1916110				1916111				1916112				1916113				
	(Pa)	800	1200	2000	-	800	1200	2000	-	800	1200	2000	-	800	1200	2000	-	
	(Pa)	150	300	600	-	150	300	600	-	150	300	600	-	150	300	600	-	
Flügelgröße Sash size	max.	FAB (m)	1.2	1.1	1.0	-	1.3	1.2	1.1	-	1.4	1.3	1.2	-	1.4	1.4	1.3	-
		FAH (m)	1.4	1.4	1.4	-	1.6	1.6	1.6	-	1.7	1.7	1.7	-	1.8	1.8	1.8	-
	min.	FAB (m)	0.425	0.425	0.425	-	0.425	0.425	0.425	-	0.425	0.425	0.425	-	0.425	0.425	0.425	-
		FAH (m)	0.7	0.7	0.7	-	0.7	0.7	0.7	-	0.7	0.7	0.7	-	0.7	0.7	0.7	-
MV / MB	FAB (m)	-	-	-	-	-	-	-	-	-	-	-	-	-	-	-	-	
	FAH (m)	1.3	1.2	1.1	-	1.4	1.3	1.2	-	1.5	1.4	1.3	-	1.5	1.5	1.4	-	
	min.	FAB (m)	0.425	0.425	0.425	-	0.425	0.425	0.425	-	0.425	0.425	0.425	-	0.425	0.425	0.425	-
		FAH (m)	0.7	0.7	0.7	-	0.7	0.7	0.7	-	0.7	0.7	0.7	-	0.7	0.7	0.7	-
	min.	FAB (m)	0.68	0.68	0.68	-	0.68	0.68	0.68	-	0.68	0.68	0.68	-	0.68	0.68	0.68	-
		FAH (m)	0.9	0.9	0.9	-	0.9	0.9	0.9	-	0.9	0.9	0.9	-	0.9	0.9	0.9	-
	max.(kg)	80				100				100				100				

WICLINE 65

Verdeckte Beschläge
Concealed fittings



Zulässige Flügelgrößen
Admissible sash sizes



Profile
Profiles

1916112

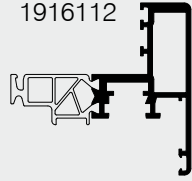

1916113

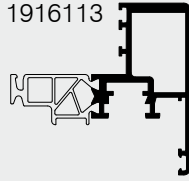

	(Pa)	800	1200	2000	-	800	1200	2000	-									
	(Pa)	150	300	600	-	150	300	600	-									
Flügelgröße Sash size	max.	FAB (m)	1.4	1.3	1.2	-	1.4	1.4	1.3	-								
		FAH (m)	1.8	2.0	2.1	-	2.0	2.0	2.25	-								
	min.	FAB (m)	0.425	0.425	0.425	-	0.425	0.425	0.425	-								
		FAH (m)	0.7	0.7	0.7	-	0.7	0.7	0.7	-								
MV / MB	FAB (m)	-	-	-	-	-	-	-	-									
	FAH (m)	1.5	1.4	1.3	-	1.5	1.5	1.4	-									
	min.	FAB (m)	0.425	0.425	0.425	-	0.425	0.425	0.425	-								
		FAH (m)	0.7	0.7	0.7	-	0.7	0.7	0.7	-								
	min.	FAB (m)	0.68	0.68	0.68	-	0.68	0.68	0.68	-								
		FAH (m)	0.9	0.9	0.9	-	0.9	0.9	0.9	-								
	max. (kg)	130***				130***												

*** Zusätzliche Verklebung, Angaben in den Verarbeitungsrichtlinien beachten!
*** Additional gluing, pay attention to specifications in the workshop manual!

WICLINE 65

Verdeckte Beschläge
Concealed fittings



Zulässige Flügelgrößen
Admissible sash sizes



Profile Profiles		1916101				1916102				1916103				1916104				1916105				1916115				
	(Pa)	800	1200	2000	-	800	1200	2000	2000	800	1200	2000	2000*	800	1200	2000*	-	800	1200	2000	-	800	1200	2000	-	
	(Pa)	150	300	600	-	150	300	600	600	150	300	600	600	150	300	600	600	150	300	600	-	150	300	600	-	
Flügelgröße Sash size	max.	FAB (m)	1.7	1.7	1.7	-	2.0	2.0	2.0	2.25	2.25	2.25	2.25	2.5	2.5	2.5	2.5	2.5	2.5	2.5	2.5	-	2.5	2.5	2.5	-
		FAH (m)	1.3	1.2	1.1	-	1.6	1.5	1.4	1.0	1.6	1.6	1.5	1.0	1.7	1.7	1.6	-	1.7	1.7	1.6	-				
	min.	FAB (m)	0.6	0.6	0.6	-	0.6	0.6	0.6	0.6	0.6	0.6	0.6	0.6	0.6	0.6	0.6	-	0.6	0.6	0.6	-	0.6	0.6	0.6	-
		FAH (m)	0.45	0.45	0.45	-	0.45	0.45	0.45	0.45	0.45	0.45	0.45	0.45	0.45	0.45	0.45	-	0.45	0.45	0.45	-	0.45	0.45	0.45	-
MV / MB	FAB (m)	1.5	1.5	1.3	-	1.7	1.6	1.5	1.5	1.8	1.7	1.6	1.5*	1.8	1.7	1.6*	-	1.8	1.7	1.6*	-	1.8	1.7	1.6*	-	
	FAH (m)	-	-	-	-	-	-	1.3	-	-	-	1.3	-	-	-	1.3	-	-	-	1.3	-	-	-	1.3	-	
	min.	FAB (m)	0.74	0.74	0.74	-	0.74	0.74	0.74	0.74	0.74	0.74	0.74	0.74	0.74	0.74	0.74	-	0.74	0.74	0.74	-	0.74	0.74	0.74	-
		FAH (m)	0.45	0.45	0.45	-	0.45	0.45	0.45	0.45	0.45	0.45	0.45	0.45	0.45	0.45	0.45	-	0.45	0.45	0.45	-	0.45	0.45	0.45	-
	min.	FAB (m)	0.9	0.9	0.9	-	0.9	0.9	0.9	0.9	0.9	0.9	0.9	0.9	0.9	0.9	0.9	-	0.9	0.9	0.9	-	0.9	0.9	0.9	-
		FAH (m)	0.6	0.6	0.6	-	0.6	0.6	0.6	0.6	0.6	0.6	0.6	0.6	0.6	0.6	0.6	-	0.6	0.6	0.6	-	0.6	0.6	0.6	-
	max. (kg)	100 (Klotzabst. 50 mm zur Ecke) (Shim dist. to corner 50 mm)				130				130				130												

* Windlast > 1600 Pa und FAB > 2.25 m werden zwei horizontale Zusatzverriegelungen benötigt
* Wind load > 1600 Pa and FAB > 2.25 m requires two horizontal additional locking points

WICLINE 65

Verdeckte Beschläge
Concealed fittings



Zulässige Flügelgrößen
Admissible sash sizes



Profile Profiles		1916110				1916111				1916112				1916113				
	(Pa)	800	1200	2000	-	800	1200	2000	-	800	1200	2000	-	800	1200	2000	-	
	(Pa)	150	300	600	-	150	300	600	-	150	300	600	-	150	300	600	-	
Flügelgröße Sash size	max.	FAB (m)	1.4	1.4	1.4	-	1.6	1.6	1.6	-	1.7	1.7	1.7	-	1.8	1.8	1.8	-
		FAH (m)	1.2	1.1	1.0	-	1.3	1.2	1.1	-	1.4	1.3	1.2	-	1.4	1.4	1.3	-
	min.	FAB (m)	0.6	0.6	0.6	-	0.6	0.6	0.6	-	0.6	0.6	0.6	-	0.6	0.6	0.6	-
		FAH (m)	0.45	0.45	0.45	-	0.45	0.45	0.45	-	0.45	0.45	0.45	-	0.45	0.45	0.45	-
MV / MB	FAB (m)	1.3	1.2	1.1	-	1.4	1.3	1.2	-	1.5	1.4	1.3	-	1.5	1.5	1.4	-	
	FAH (m)	-	-	-	-	-	-	-	-	-	-	-	-	-	-	-	-	
	min.	FAB (m)	0.74	0.74	0.74	-	0.74	0.74	0.74	-	0.74	0.74	0.74	-	0.74	0.74	0.74	-
		FAH (m)	0.45	0.45	0.45	-	0.45	0.45	0.45	-	0.45	0.45	0.45	-	0.45	0.45	0.45	-
	min.	FAB (m)	0.9	0.9	0.9	-	0.9	0.9	0.9	-	0.9	0.9	0.9	-	0.9	0.9	0.9	-
		FAH (m)	0.6	0.6	0.6	-	0.6	0.6	0.6	-	0.6	0.6	0.6	-	0.6	0.6	0.6	-
	max.(kg)	80				100				100				100				

6

WICLINE 65

Verdeckte Beschläge
Concealed fittings



Zulässige Flügelgrößen
Admissible sash sizes



Profile Profiles		1916112				1916113											
	(Pa)	800	1200	2000	-	800	1200	2000	-								
	(Pa)	150	300	600	-	150	300	600	-								
Flügelgröße Sash size	max.	FAB (m)	1.8	2.0	2.1	-	2.0	2.0	2.25	-							
		FAH (m)	1.4	1.3	1.2	-	1.4	1.4	1.3	-							
	min.	FAB (m)	0.6	0.6	0.6	-	0.6	0.6	0.6	-							
		FAH (m)	0.45	0.45	0.45	-	0.45	0.45	0.45	-							
MV / MB	FAB (m)	1.5	1.4	1.3	-	1.5	1.5	1.4	-								
	FAH (m)	-	-	-	-	-	-	-	-								
	min.	FAB (m)	0.74	0.74	0.74	-	0.74	0.74	0.74	-							
		FAH (m)	0.45	0.45	0.45	-	0.45	0.45	0.45	-							
	min.	FAB (m)	0.9	0.9	0.9	-	0.9	0.9	0.9	-							
		FAH (m)	0.6	0.6	0.6	-	0.6	0.6	0.6	-							
	max. (kg)	130***				130***											

*** Zusätzliche Verklebung, Angaben in den Verarbeitungsrichtlinien beachten!
*** Additional gluing, pay attention to specifications in the workshop manual!

WICLINE 65

Verdeckte Beschläge
Concealed fittings



Zulässige Flügelgrößen
Admissible sash sizes



Profile
Profiles

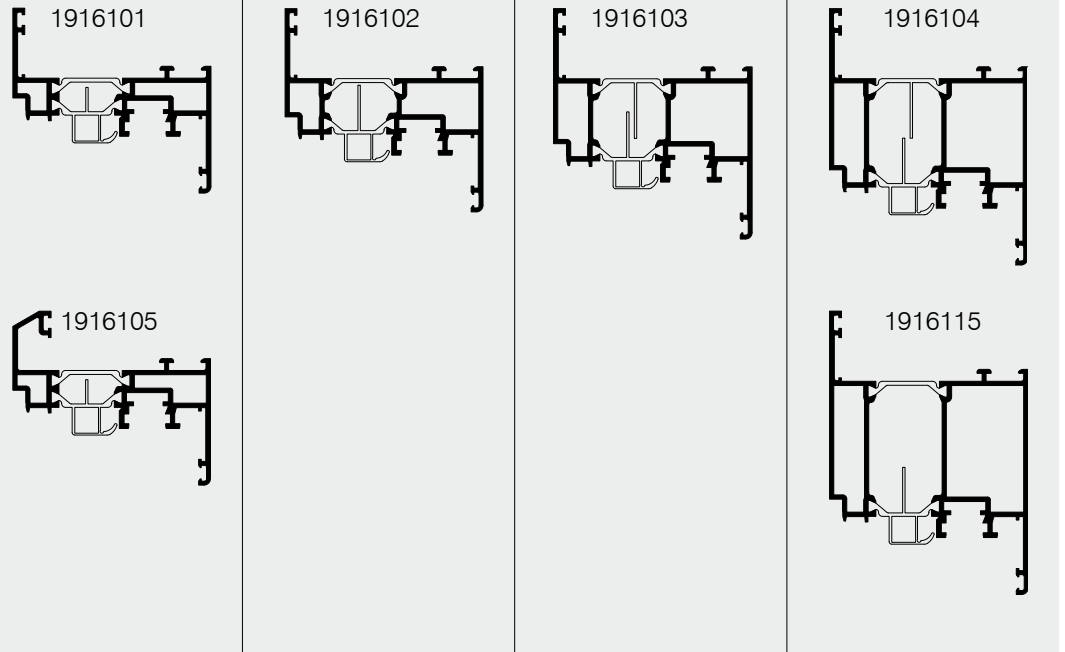

	(Pa)	800	1200	2000	-	800	1200	2000	2000	800	1200	2000	2000*	800	1200	2000*	-		
	(Pa)	150	300	600	-	150	300	600	600	150	300	600	600	150	300	600	-		
Flügelgröße Sash size	max.	FAB (m)	1.7	1.7	1.7	-	2.0	2.0	2.0	2.25	2.25	2.25	2.25	2.5	2.5	2.5	2.5	-	
		FAH (m)	1.3	1.2	1.1	-	1.6	1.5	1.4	1.0	1.6	1.6	1.5	1.0	1.7	1.7	1.6	-	
	min.	FAB (m)	0.55	0.55	0.55	-	0.55	0.55	0.55	0.55	0.55	0.55	0.55	0.55	0.55	0.55	0.55	0.55	-
		FAH (m)	0.51	0.51	0.51	-	0.51	0.51	0.51	0.51	0.51	0.51	0.51	0.51	0.51	0.51	0.51	0.51	-
MV / MB	FAB (m)	1.5	1.5	1.3	-	1.7	1.6	1.5	1.5	1.8	1.7	1.6	1.5*	1.8	1.7	1.6*	-		
	FAH (m)	-	-	-	-	-	-	1.3	-	-	-	1.3	-	-	-	1.3	-		
	min.	FAB (m)	-	-	-	-	-	-	-	-	-	-	-	-	-	-	-		
		FAH (m)	-	-	-	-	-	-	-	-	-	-	-	-	-	-	-		
	min.	FAB (m)	-	-	-	-	-	-	-	-	-	-	-	-	-	-	-		
		FAH (m)	-	-	-	-	-	-	-	-	-	-	-	-	-	-	-		
	max. (kg)	80 (Klotzabst. 50 mm zur Ecke) (Shim dist. to corner 50 mm)				80 / 120													

* Windlast > 1600 Pa und FAB > 2.25 m werden zwei horizontale Zusatzverriegelungen/Mittelbänder benötigt

* Wind load > 1600 Pa and FAB 2.25 m requires two horizontal additional locking points/centre hinges

WICLINE 65

Verdeckte Beschläge
Concealed fittings



Zulässige Flügelgrößen
Admissible sash sizes



Profile Profiles		1916110				1916111				1916112				1916113				
	(Pa)	800	1200	2000	-	800	1200	2000	-	800	1200	2000	-	800	1200	2000	-	
	(Pa)	150	300	600	-	150	300	600	-	150	300	600	-	150	300	600	-	
Flügelgröße Sash size	max.	FAB (m)	1.4	1.4	1.4	-	1.6	1.6	1.6	-	1.7	1.7	1.7	-	1.8	1.8	1.8	-
		FAH (m)	1.2	1.1	1.0	-	1.3	1.2	1.1	-	1.4	1.3	1.2	-	1.4	1.4	1.3	-
	min.	FAB (m)	0.55	0.55	0.55	-	0.55	0.55	0.55	-	0.55	0.55	0.55	-	0.55	0.55	0.55	-
		FAH (m)	0.51	0.51	0.51	-	0.51	0.51	0.51	-	0.51	0.51	0.51	-	0.51	0.51	0.51	-
MV / MB	FAB (m)	1.3	1.2	1.1	-	1.4	1.3	1.2	-	1.5	1.4	1.3	-	1.5	1.5	1.4	-	
	FAH (m)	-	-	-	-	-	-	-	-	-	-	-	-	-	-	-	-	
	min.	FAB (m)	-	-	-	-	-	-	-	-	-	-	-	-	-	-	-	-
		FAH (m)	-	-	-	-	-	-	-	-	-	-	-	-	-	-	-	-
	min.	FAB (m)	-	-	-	-	-	-	-	-	-	-	-	-	-	-	-	-
		FAH (m)	-	-	-	-	-	-	-	-	-	-	-	-	-	-	-	-
	max.(kg)	80				80				80				80				

WICLINE 65

Verdeckte Beschläge
Concealed fittings



Zulässige Flügelgrößen
Admissible sash sizes



Profile
Profiles

1916112

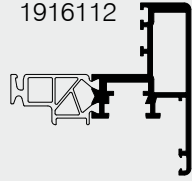

1916113

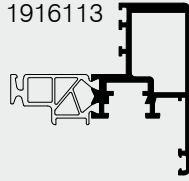

	(Pa)	800	1200	2000	-	800	1200	2000	-								
	(Pa)	150	300	600	-	150	300	600	-								
Flügelgröße Sash size	max.	FAB (m)	1.8	2.0	2.1	-	2.0	2.0	2.25	-							
		FAH (m)	1.4	1.3	1.2	-	1.4	1.4	1.3	-							
	min.	FAB (m)	0.55	0.55	0.55	-	0.55	0.55	0.55	-							
		FAH (m)	0.51	0.51	0.51	-	0.51	0.51	0.51	-							
MV / MB	FAB (m)	1.5	1.4	1.3	-	1.5	1.5	1.4	-								
	FAH (m)	-	-	-	-	-	-	-	-								
	min.	FAB (m)	-	-	-	-	-	-	-	-							
		FAH (m)	-	-	-	-	-	-	-	-							
	min.	FAB (m)	-	-	-	-	-	-	-	-							
		FAH (m)	-	-	-	-	-	-	-	-							
	max. (kg)	80 / 120***				80 / 120***											

*** Zusätzliche Verklebung, Angaben in den Verarbeitungsrichtlinien beachten!
*** Additional gluing, pay attention to specifications in the workshop manual!

WICLINE 65

Verdeckte Beschläge
Concealed fittings



Zulässige Flügelgrößen
Admissible sash sizes



Profile
Profiles

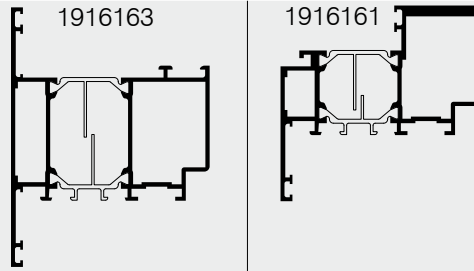

Bei Verwendung von Elektroantrieben $FAH_{min.}$ auf Antrieb anpassen. Bei Anwendung in Fassaden ist eine Riegelüberprüfung erforderlich.
When using electric drives adjust $FAH_{min.}$ to drive. Check transom profile for application in façades.

	(Pa)	-	-	2000	2000	-	2000	2000	2000									
	(Pa)	-	-	600	600	-	600	600	600									
Flügelgröße Sash size	max.	FAB (m)	-	-	2.2	2.0	-	1.4	1.8	1.4								
		FAH (m)	-	-	2.0	2.2	-	1.4	1.4	1.8								
	min.	FAB (m)	-	-	0.6	0.6	-	0.6	0.6	0.6								
		FAH (m)	-	-	0.5**	0.5**	-	0.5**	0.5**	0.5**								
MV / MB	FAB (m)	-	-	1.5*	1.5*	-	-	1.4	-									
	FAH (m)	-	-	1.5	1.5	-	-	-	1.4									
	min.	FAB (m)	-	-	-	-	-	-	-	-								
		FAH (m)	-	-	-	-	-	-	-	-								
	min.	FAB (m)	-	-	-	-	-	-	-	-								
		FAH (m)	-	-	-	-	-	-	-	-								
	max. (kg)	150 (zus. Verklebung > 120 kg) (add. gluing > 120 kg)				120		100										

* FAB > 1.8 m werden oben zwei horizontale Zusatzverriegelungen benötigt
* FAB > 1.8 m requires two horizontal additional top locking points

** $FAH_{min.}$ > 0.65 Rastschere möglich!
** $FAH_{min.}$ > 0.65 opening limiter with catch possible!



$FAH \leq 2.5 \times FAB$

WICLINE 65

Aufliegende Beschläge
Top mounted fittings

Zulässige Flügelgrößen
Admissible sash sizes



Profile
Profiles

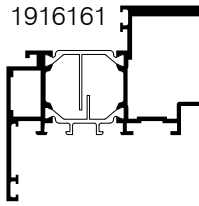
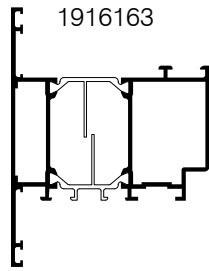

Bei Verwendung von Elektroantrieben FAH_{min} auf Antrieb anpassen. Bei Anwendung in Fassaden ist eine Riegelüberprüfung erforderlich.

When using electric drives adjust FAH_{min} to drive. Check transom profile for application in façades.

	(Pa)	-	2000	2000	2000	-	2000	2000	2000									
	(Pa)	-	600	600	600	-	600	600	600									
Flügelgröße Sash size	max.	FAB (m)	-	1.5	2.0	2.0	-	1.4	1.8	1.4								
		FAH (m)	-	1.5	2.0	2.0	-	1.4	1.4	1.8								
	min.	FAB (m)	-	0.6	0.6	0.6	-	0.6	0.6	0.6								
		FAH (m)	-	0.425	0.425	0.425	-	0.425	0.425	0.425								
MV / MB	FAB (m)	-	-	1.5	1.5*	-	-	1.4	-									
	FAH (m)	-	-	1.5	1.5	-	-	-	1.4									
	min.	FAB (m)	-	-	-	-	-	-	-									
		FAH (m)	-	-	-	-	-	-	-	-								
	min.	FAB (m)	-	-	-	-	-	-	-									
		FAH (m)	-	-	-	-	-	-	-	-								
	max. (kg)		80	100	150***		80	100										

* FAB > 1.8 m werden zwei horizontale Mittelbänder (MB) benötigt
* FAB > 1.8 m requires two horizontal centre hinges (MB)

*** Zusätzliche Verklebung > 120 kg
*** Additional gluing > 120 kg



$FAH \leq 2.5 \times FAB$

WICLINE 65

Aufliegende Beschläge
Top mounted fittings

Zulässige Flügelgrößen
Admissible sash sizes



Profile
Profiles

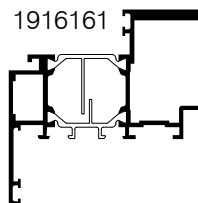
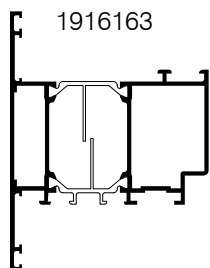

	(Pa)	-	2000	2000	2000	-	2000	2000	2000	-	2000	2000	2000	-	2000	2000	2000	
	(Pa)	-	600	600	600	-	600	600	600	-	600	600	600	-	600	600	600	
Flügelgröße Sash size	max.	FAB (m)	-	2.4	2.3	2.1	-	1.9	1.7	2.0	-	2.3	2.2	2.1	-	2.0	1.9	1.8
		FAH (m)	-	1.4	1.5	1.6	-	1.8	2.0	1.7	-	1.0	1.1	1.2	-	1.4	1.6	1.8
	min.	FAB (m)	-	0.7	0.7	0.7	-	0.7	0.7	0.7	-	0.7	0.7	0.7	-	0.7	0.7	0.7
		FAH (m)	-	0.7	0.7	0.7	-	0.7	0.7	0.7	-	0.7	0.7	0.7	-	0.7	0.7	0.7
MV / MB	FAB (m)	-	1.5	1.5	1.5	-	1.5	1.5	1.5	-	1.4	1.4	1.4	-	1.4	1.4	1.4	
	FAH (m)	-	-	-	-	-	-	-	-	-	-	-	-	-	-	-	-	
	min.	FAB (m)	-	-	-	-	-	-	-	-	-	-	-	-	-	-	-	
		FAH (m)	-	-	-	-	-	-	-	-	-	-	-	-	-	-	-	
	min.	FAB (m)	-	-	-	-	-	-	-	-	-	-	-	-	-	-	-	
		FAH (m)	-	-	-	-	-	-	-	-	-	-	-	-	-	-	-	
	max.(kg)		100				100				80				100			

WICLINE 65

Verdeckte Beschläge
Concealed fittings



Zulässige Flügelgrößen
Admissible sash sizes



Profile
Profiles

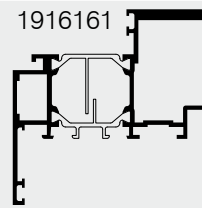
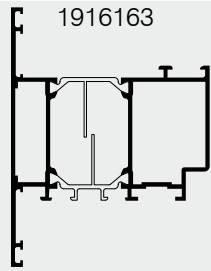

	(Pa)	-	2000	2000	2000	-	-	2000	2000	-	2000	2000	2000	-	2000	2000	2000	
	(Pa)	-	600	600	600	-	-	600	600	-	600	600	600	-	600	600	600	
Flügelgröße Sash size	max.	FAB (m)	-	2.5	2.4	2.3	-	-	2.0	2.2	-	2.3	2.2	2.1	-	2.0	1.9	1.8
		FAH (m)	-	1.4	1.6	1.8	-	-	2.2	2.0	-	1.0	1.1	1.2	-	1.4	1.6	1.8
	min.	FAB (m)	-	0.7	0.7	0.7	-	-	0.7	0.7	-	0.7	0.7	0.7	-	0.7	0.7	0.7
		FAH (m)	-	0.7	0.7	0.7	-	-	0.7	0.7	-	0.7	0.7	0.7	-	0.7	0.7	0.7
MV / MB	FAB (m)	-	1.5	1.5	1.5	-	-	1.5	1.5	-	1.4	1.4	1.4	-	1.4	1.4	1.4	
	FAH (m)	-	-	-	-	-	-	-	-	-	-	-	-	-	-	-	-	
	min.	FAB (m)	-	-	-	-	-	-	-	-	-	-	-	-	-	-	-	
		FAH (m)	-	-	-	-	-	-	-	-	-	-	-	-	-	-	-	
	min.	FAB (m)	-	-	-	-	-	-	-	-	-	-	-	-	-	-	-	
		FAH (m)	-	-	-	-	-	-	-	-	-	-	-	-	-	-	-	
	max. (kg)		120			150			80			100						

WICLINE 65

Aufliegende Beschläge
Top mounted fittings

Zulässige Flügelgrößen
Admissible sash sizes



Profile Profiles		1916163				1916161											
	(Pa)	800	800	-	-	800	800	-	-								
	(Pa)	150	150	-	-	150	150	-	-								
Flügelgröße Sash size	max.	FAB (m)	1.8	1.7	-	-	1.8	1.6	-	-							
		FAH (m)	1.8	2.0	-	-	1.8	1.9	-	-							
	min.	FAB (m)	0.7	0.7	-	-	0.7	0.7	-	-							
		FAH (m)	0.7	0.7	-	-	0.7	0.7	-	-							
MV / MB	FAB (m)	-	-	-	-	-	-	-	-								
	FAH (m)	1.5	1.5	-	-	1.4	1.4	-	-								
	min.	FAB (m)	-	-	-	-	-	-	-	-							
		FAH (m)	-	-	-	-	-	-	-	-							
	min.	FAB (m)	-	-	-	-	-	-	-	-							
		FAH (m)	-	-	-	-	-	-	-	-							
	max.(kg)	100				100											

WICLINE 65

Verdeckte Beschläge
Concealed fittings







Zulässige Flügelgrößen
Admissible sash sizes

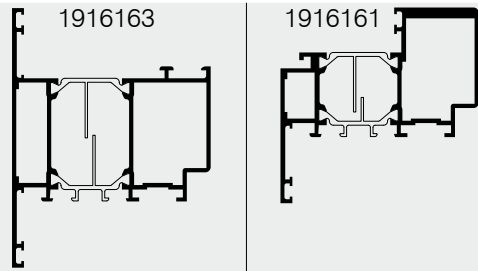

Profile
Profiles

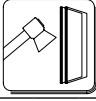
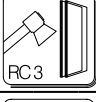

	(Pa)	800	800	-	-	800	800	-	-								
	(Pa)	150	150	-	-	150	150	-	-								
Flügelgröße Sash size	max.	FAB (m)	2.0	1.8	-	-	1.8	1.6	-	-							
		FAH (m)	2.0	2.2	-	-	1.8	1.9	-	-							
	min.	FAB (m)	0.7	0.7	-	-	0.7	0.7	-	-							
		FAH (m)	0.7	0.7	-	-	0.7	0.7	-	-							
MV / MB	FAB (m)	-	-	-	-	-	-	-	-								
	FAH (m)	1.5	1.5	-	-	1.4	1.4	-	-								
	min.	FAB (m)	-	-	-	-	-	-	-								
		FAH (m)	-	-	-	-	-	-	-	-							
	min.	FAB (m)	-	-	-	-	-	-	-								
		FAH (m)	-	-	-	-	-	-	-	-							
	max.(kg)			120		100											

6

WICLINE 65

Zulässige Flügelgrößen Admissible sash sizes

Aufliegende Beschläge, Fenstertür einwärts
Top mounted fittings, casement door inwards



Profile
Profiles

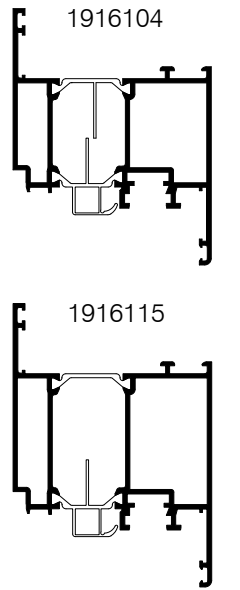

	(Pa)	800	1200	1600	2000*														
	(Pa)	150	300	600	600														
Flügelgröße Sash size	max.	FAB (m)	1.7	1.7	1.6	1.6													
		FAH (m)	2.5	2.5	2.5	2.5													
	min.	FAB (m)	0.425	0.425	0.425	0.425													
		FAH (m)	0.95	0.95	0.95	0.95													
MV / MB	FAB (m)	-	-	-	1.3														
	FAH (m)	1.8	1.7	1.6	1.6*														
	min.	FAB (m)	-	-	-	-													
		FAH (m)	-	-	-	-													
	min.	FAB (m)	-	-	-	-													
		FAH (m)	-	-	-	-													
	max. (kg)		160																

* Windlast > 1600 Pa und FAH > 2.25 m werden zwei vertikale Zusatzverriegelung benötigt
* Wind load > 1600 Pa and FAH > 2.25 m requires two vertical additional locking points







WICLINE 65

Verdeckte Beschläge,
Fenster/einwärts
*Concealed fittings,
casement door inwards*

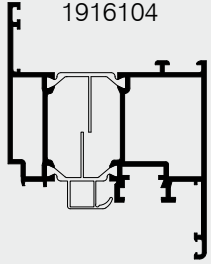
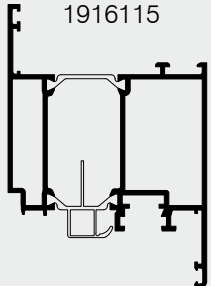

Zulässige Flügelgrößen
Admissible sash sizes



Profile <i>Profiles</i>		 1916104												
		 1916115												
	(Pa)	800	1200	1600	2000*									
	(Pa)	150	300	600	600									
Flügelgröße <i>Sash size</i>	max.	FAB (m)	1.7	1.7	1.6	1.6								
		FAH (m)	2.5	2.5	2.5	2.5								
	min.	FAB (m)	0.45	0.45	0.45	0.45								
		FAH (m)	0.95	0.95	0.95	0.95								
MV / MB	FAB (m)	-	-	-	1.3									
	FAH (m)	1.8	1.7	1.6	1.6*									
	min.	FAB (m)	-	-	-	-								
		FAH (m)	-	-	-	-								
	min.	FAB (m)	-	-	-	-								
		FAH (m)	-	-	-	-								
	max. (kg)	160												

* Windlast > 1600 Pa und FAH > 2.25 m werden zwei vertikale Zusatzverriegelung benötigt
 * *Wind load > 1600 Pa and FAH > 2.25 m requires two vertical additional locking points*

WICLINE 65

Zulässige Flügelgrößen

Admissible sash sizes

Aufliegende Beschläge, Fenstertür einwärts, barrierefrei
 Top mounted fittings, casement door inwards, accessible



Profile
 Profiles

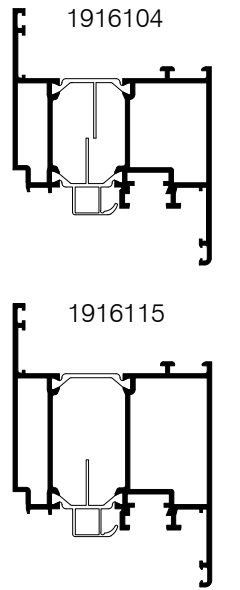

	(Pa)	800	1200	1600	2000*														
	(Pa)	150	300	600	600														
Flügelgröße Sash size	max.	FAB (m)	1.4	1.4	1.3	1.3													
		FAH (m)	2.5	2.5	2.5	2.5													
	min.	FAB (m)	0.425	0.425	0.425	0.425													
		FAH (m)	0.95	0.95	0.95	0.95													
MV / MB	FAB (m)	-	-	-	-														
	FAH (m)	1.8	1.7	1.6	1.5*														
	min.	FAB (m)	-	-	-	-													
		FAH (m)	-	-	-	-													
	min.	FAB (m)	-	-	-	-													
		FAH (m)	-	-	-	-													
	max.(kg)		130																





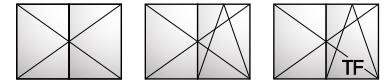

* Windlast > 1600 Pa und FAH > 2.25 m werden zwei vertikale Zusatzverriegelung benötigt
 * Wind load > 1600 Pa and FAH > 2.25 m requires two vertical additional locking points

WICLINE 65

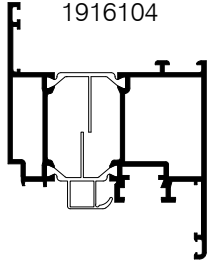
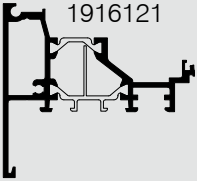
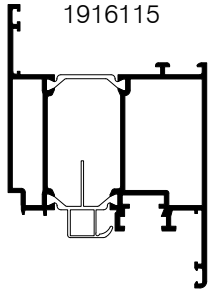
Aufliegende Beschläge, Fenstertür einwärts
 Top mounted fittings, casement door inwards

Zulässige Flügelgrößen
 Admissible sash sizes



Profile Profiles		 1916104																	
 1916121 Stulpaufsatzprofil mit Stulpgetriebe Double casement supplement profile with double casement gear		 1916115																	
	(Pa)	800	1200	1600* (2.0)**	-														
	(Pa)	150	300	600	-														
Flügelgröße Sash size	max.	FAB (m)	1.7	1.7	1.6	-													
		FAH (m)	2.5	2.5	2.5	-													
	min.	FAB (m)	0.425	0.425	0.425	-													
		FAH (m)	0.95	0.95	0.95	-													
MV / MB	FAB (m)	1.3	1.3	1.3	-														
	FAH (m)	1.8	1.7	1.6*	-														
	min.	FAB (m)	-	-	-	-													
		FAH (m)	-	-	-	-													
	min.	FAB (m)	-	-	-	-													
		FAH (m)	-	-	-	-													
	max.(kg)	160																	

* Windlast > 1200 Pa und FAH > 2.25 m werden zwei vertikale Zusatzverriegelung benötigt
 * Wind load > 1200 Pa and FAH > 2.25 m requires two vertical additional locking points

** Flügelgröße > () m² benötigt eine horizontale Zusatzverriegelung am Gehflügel und Standflügel
 ** Sash size > () m² requires a horizontal additional locking point on active leaf and inactive leaf





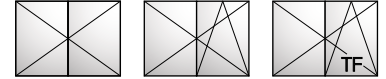

WICLINE 65

Verdeckte Beschläge,
Fenstertür einwärts
*Concealed fittings,
casement door inwards*

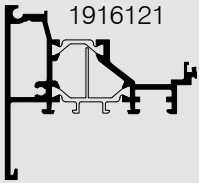
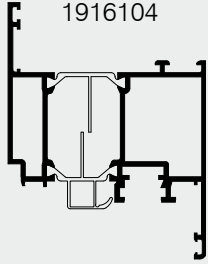
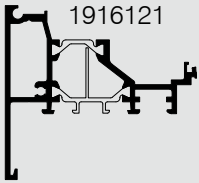
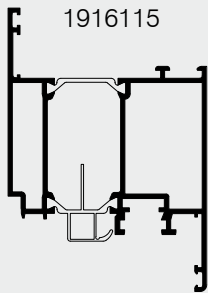

Zulässige Flügelgrößen
Admissible sash sizes



Profile <i>Profiles</i>		1916104				1916121				1916115												
 Stulpaufsatzprofil mit Stulpgetriebe <i>Double casement supplement profile with double casement gear</i>		 1916104				 1916121				 1916115												
	(Pa)	800	1200	1600* (2.0)**	-																	
	(Pa)	150	300	600	-																	
Flügelgröße <i>Sash size</i>	max.	FAB (m)	1.7	1.7	1.6	-																
		FAH (m)	2.5	2.5	2.5	-																
	min.	FAB (m)	0.45	0.45	0.45	-																
		FAH (m)	0.95	0.95	0.95	-																
MV / MB	FAB (m)	1.3	1.3	1.3	-																	
	FAH (m)	1.8	1.7	1.6*	-																	
	min.	FAB (m)	-	-	-	-																
		FAH (m)	-	-	-	-																
	min.	FAB (m)	-	-	-	-																
		FAH (m)	-	-	-	-																
	max. (kg)	160																				

* Windlast > 1200 Pa und FAH > 2.25 m werden zwei vertikale Zusatzverriegelung benötigt
 * *Wind load > 1200 Pa and FAH > 2.25 m requires two vertical additional locking points*

** Flügelgröße > () m² benötigt eine horizontale Zusatzverriegelung am Gehflügel und Standflügel
 ** *Sash size > () m² requires an additional horizontal locking point on active leaf and inactive leaf*

WICLINE 65

Aufliegende Beschläge, Fenstertür einwärts
Top mounted fittings, casement door inwards

Zulässige Flügelgrößen
Admissible sash sizes

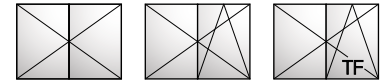

Profile
Profiles

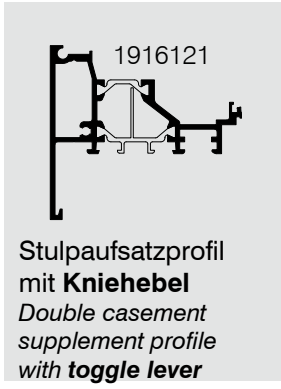
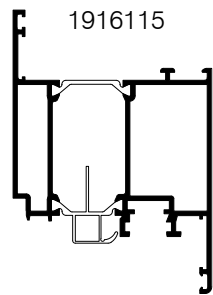
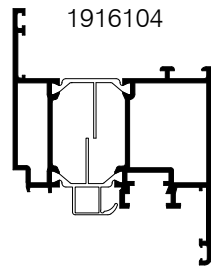

	(Pa)	800	1200	1600 (2.0)**	-													
	(Pa)	150	300	600	-													
Flügelgröße Sash size	max.	FAB (m)	1.3	1.3	1.3	-												
		FAH (m)	2.25	2.25	2.25	-												
	min.	FAB (m)	0.425	0.425	0.425	-												
		FAH (m)	0.95	0.95	0.95	-												
MV / MB	FAB (m)	-	-	-	-													
	FAH (m)	1.8	1.7	1.6	-													
	min.	FAB (m)	-	-	-	-												
		FAH (m)	-	-	-	-												
	min.	FAB (m)	-	-	-	-												
		FAH (m)	-	-	-	-												
	max. (kg)		160															

** Flügelgröße > () m² benötigt eine horizontale Zusatzverriegelung am Gehflügel
 ** Sash size > () m² requires an additional horizontal locking point on the active leaf

WICLINE 65

Verdeckte Beschläge,
Fenstertür einwärts
*Concealed fittings,
casement door inwards*



Zulässige Flügelgrößen
Admissible sash sizes

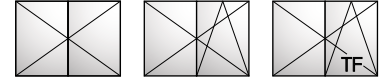

Profile <i>Profiles</i>		1916104				1916121				1916115												
 Stulpaufsatzprofil mit Kniehebel <i>Double casement supplement profile with toggle lever</i>																						
	(Pa)	800	1200	1600 (2.0)**	-																	
	(Pa)	150	300	600	-																	
Flügelgröße <i>Sash size</i>	max.	FAB (m)	1.3	1.3	1.3	-																
		FAH (m)	2.25	2.25	2.25	-																
	min.	FAB (m)	0.45	0.45	0.45	-																
		FAH (m)	0.95	0.95	0.95	-																
MV / MB	FAB (m)	-	-	-	-																	
	FAH (m)	1.8	1.7	1.6	-																	
	min.	FAB (m)	-	-	-	-																
		FAH (m)	-	-	-	-																
	min.	FAB (m)	-	-	-	-																
		FAH (m)	-	-	-	-																
	max. (kg)	160																				

** Flügelgröße > () m² benötigt eine horizontale Zusatzverriegelung am Gehflügel
 ** Sash size > () m² requires an additional horizontal locking point on the active leaf

WICLINE 65

Aufliegende Beschläge, Fenstertür einwärts, barrierefrei
 Top mounted fittings, casement door inwards, accessible

Zulässige Flügelgrößen
 Admissible sash sizes



Profile
 Profiles

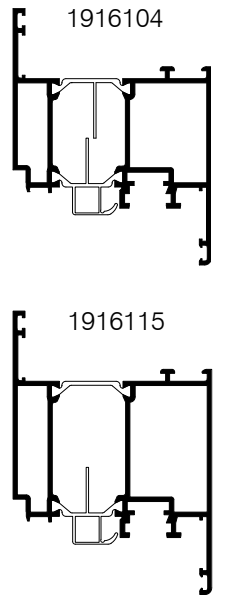
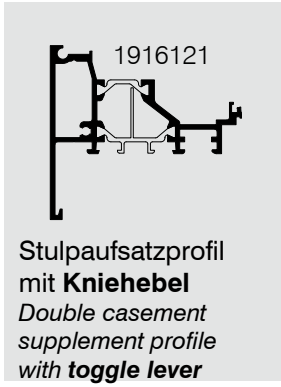

	(Pa)	400	800	1200* (2.0)**	-														
	(Pa)	150	200	300	-														
Flügelgröße Sash size	max.	FAB (m)	1.2	1.1	1.0	-													
		FAH (m)	2.5	2.5	2.5	-													
	min.	FAB (m)	0.425	0.425	0.425	-													
		FAH (m)	0.95	0.95	0.95	-													
MV / MB	FAB (m)	-	-	-	-														
	FAH (m)	1.8	1.7	1.6*	-														
	min.	FAB (m)	-	-	-	-													
		FAH (m)	-	-	-	-													
	min.	FAB (m)	-	-	-	-													
		FAH (m)	-	-	-	-													
	max. (kg)		130																

* Windlast > 800 Pa und FAH > 2.25 m werden zwei vertikale Zusatzverriegelung benötigt
 * Wind load > 800 Pa and FAH > 2.25 m requires two vertical additional locking points

** Flügelgröße > () m² benötigt eine horizontale Zusatzverriegelung am Gehflügel oben
 ** Sash size > () m² requires an additional horizontal locking point on the active leaf on top

WICLINE 65





Zulässige Flügelgrößen Admissible sash sizes

Aufliegende Beschläge, Fenstertür auswärts
Top mounted fittings, casement door outwards

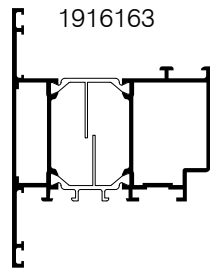

Profile
Profiles



		1916163																
	(Pa)	2000	2000	2000	2000													
	(Pa)	600	600	600	600													
Flügelgröße Sash size	max.	FAB (m)	1.2	1.5	1.4	1.2												
		FAH (m)	2.25	2.1	2.25	2.5												
	min.	FAB (m)	0.425	0.425	0.425	0.425												
		FAH (m)	0.75	0.75	0.75	0.75												
MV / MB	FAB (m)	-	1.3	1.3	-													
	FAH (m)	1.4	1.4	1.4	1.4													
	min.	FAB (m)	-	-	-	-												
		FAH (m)	-	-	-	-												
	min.	FAB (m)	-	-	-	-												
		FAH (m)	-	-	-	-												
	max.(kg)	80	100															

WICLINE 65

Zulässige Flügelgrößen Admissible sash sizes

Aufliegende Beschläge, Fenstertür auswärts, barrierefrei
Top mounted fittings, casement door outwards, accessible



Profile
Profiles

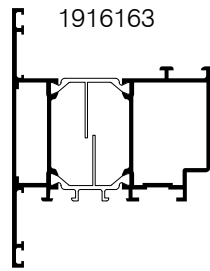

	(Pa)	800	1200	2000	-														
	(Pa)	150	300	600	-														
Flügelgröße Sash size	max.	FAB (m)	1.3	1.2	1.1	-													
		FAH (m)	2.25	2.25	2.25	-													
	min.	FAB (m)	0.425	0.425	0.425	-													
		FAH (m)	0.75	0.75	0.75	-													
MV / MB	FAB (m)	-	-	-	-														
	FAH (m)	1.4	1.4	1.4	-														
	min.	FAB (m)	-	-	-	-													
		FAH (m)	-	-	-	-													
	min.	FAB (m)	-	-	-	-													
		FAH (m)	-	-	-	-													
	max.(kg)	80 / 100																	



Bei Einsatz von 4x Bänder Flügelgewicht
max. 100 kg möglich
When using 4x hinges sash weight
max. 100 kg possible

WICLINE 65

Zulässige Flügelgrößen Admissible sash sizes

Aufliegende Beschläge, Fenstertür auswärts
Top mounted fittings, casement door outwards

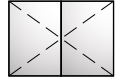

Profile
Profiles

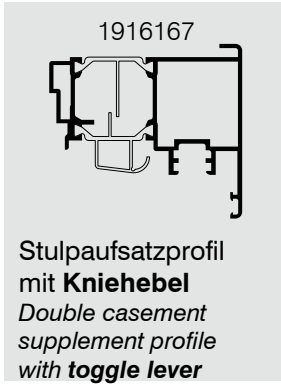
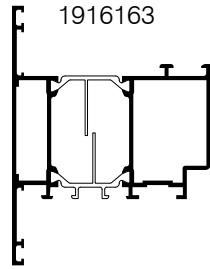

	(Pa)	1600	1600	1600	-														
	(Pa)	600	600	600	-														
Flügelgröße Sash size	max.	FAB (m)	1.3	1.2	1.0	-													
		FAH (m)	2.1	2.25	2.5	-													
	min.	FAB (m)	0.425	0.425	0.425	-													
		FAH (m)	0.75	0.75	0.75	-													
MV / MB	FAB (m)	-	-	-	-														
	FAH (m)	1.4	1.4	1.4	-														
	min.	FAB (m)	-	-	-	-													
		FAH (m)	-	-	-	-													
	min.	FAB (m)	-	-	-	-													
		FAH (m)	-	-	-	-													
	max. (kg)	80 / 100																	



Bei Einsatz von 4x Bänder Flügelgewicht
max. 100 kg möglich
When using 4x hinges sash weight
max. 100 kg possible

WICLINE 65

Zulässige Flügelgrößen Admissible sash sizes

Aufliegende Beschläge, Fenstertür auswärts, barrierefrei
Top mounted fittings, casement door outwards, accessible



Profile
Profiles

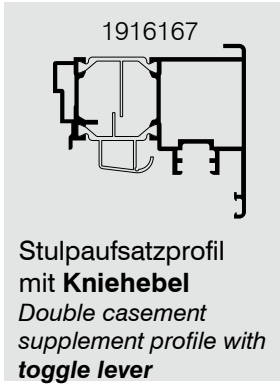
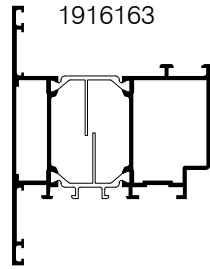

	(Pa)	400	800	1200	-														
	(Pa)	150	200	300	-														
Flügelgröße Sash size	max.	FAB (m)	1.2	1.1	1.0	-													
		FAH (m)	2.25	2.25	2.25	-													
	min.	FAB (m)	0.425	0.425	0.425	-													
		FAH (m)	0.75	0.75	0.75	-													
MV / MB	FAB (m)	-	-	-	-														
	FAH (m)	1.4	1.4	1.4	-														
	min.	FAB (m)	-	-	-	-													
		FAH (m)	-	-	-	-													
	min.	FAB (m)	-	-	-	-													
		FAH (m)	-	-	-	-													
	max.(kg)	80 / 100																	



Bei Einsatz von 4x Bänder Flügelgewicht
max. 100 kg möglich
When using 4x hinges sash weight
max. 100 kg possible

WICLINE 65

Zulässige Flügelgrößen

Admissible sash sizes

Aufliegende Beschläge, ohne Zwangssteuerung OZ

Top mounted fittings, without force control

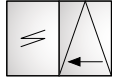

Profile Profiles		1916116				1916117				1916116				1916117				
						1916118 *								1916118 *				
	(Pa)	-	1200	2000	-	-	1200	2000	-	-	1200	2000	-	-	1200	2000	-	
	(Pa)	-	300	600	-	-	300	600	-	-	300	600	-	-	300	600	-	
Flügelgröße Sash size	max.	FAB (m)	-	1.4	1.3	-	-	1.4	1.3	-	-	1.6	1.5	-	-	1.685	1.6	-
		FAH (m)	-	2.35	2.35	-	-	2.35	2.35	-	-	2.4	2.4	-	-	2.5	2.5	-
	min.	FAB (m)	-	0.655	0.655	-	-	0.655	0.655	-	-	0.655	0.655	-	-	0.655	0.655	-
		FAH (m)	-	0.685	0.685	-	-	0.685	0.685	-	-	0.685	0.685	-	-	0.685	0.685	-
MV / MB	FAB (m)	-	-	-	-	-	-	-	-	-	-	-	-	-	-	-	-	
	FAH (m)	-	-	-	-	-	-	-	-	-	-	-	-	-	-	-	-	
	min.	FAB (m)	-	-	-	-	-	-	-	-	-	-	-	-	-	-	-	-
		FAH (m)	-	-	-	-	-	-	-	-	-	-	-	-	-	-	-	-
	min.	FAB (m)	-	-	-	-	-	-	-	-	-	-	-	-	-	-	-	-
		FAH (m)	-	-	-	-	-	-	-	-	-	-	-	-	-	-	-	-
	max. (kg)	100				100				160				160				

* für Einsatz von PZ-Getriebe DM 40

* for use of PZ gear DM 40



FAH ≤ 2 x FAB

WICLINE 65

Zulässige Flügelgrößen

Admissible sash sizes

Aufliegende Beschläge, mit Zwangssteuerung MZ

Top mounted fittings, with force control

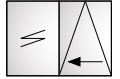

Profile Profiles		1916116				1916117				1916116				1916117				
						1916118 *								1916118 *				
	(Pa)	-	1200	2000	-	-	1200	2000	-	800	1200	2000	-	-	1200	2000	-	
	(Pa)	-	300	600	-	-	300	600	-	150	300	600	-	-	300	600	-	
Flügelgröße Sash size	max.	FAB (m)	-	1.4	1.3	-	-	1.4	1.3	-	1.6	1.5	1.4	-	-	1.6	1.5	-
		FAH (m)	-	2.35	2.35	-	-	2.35	2.35	-	2.5	2.5	2.5	-	-	2.7	2.7	-
	min.	FAB (m)	-	0.755	0.755	-	-	0.755	0.755	-	0.755	0.755	0.755	-	-	0.755	0.755	-
		FAH (m)	-	0.935	0.935	-	-	0.935	0.935	-	0.935	0.935	0.935	-	-	0.935	0.935	-
MV / MB	FAB (m)	-	-	-	-	-	-	-	-	-	-	-	-	-	-	-	-	
	FAH (m)	-	-	-	-	-	-	-	-	-	-	-	-	-	-	-	-	
	min.	FAB (m)	-	-	-	-	-	-	-	-	-	-	-	-	-	-	-	-
		FAH (m)	-	-	-	-	-	-	-	-	-	-	-	-	-	-	-	-
	min.	FAB (m)	-	-	-	-	-	-	-	-	-	-	-	-	-	-	-	-
		FAH (m)	-	-	-	-	-	-	-	-	-	-	-	-	-	-	-	-
	max.(kg)	100				100				160				160				

* für Einsatz von PZ-Getriebe DM 40

* for use of PZ gear DM 40



FAH ≤ 2 x FAB

WICLINE 65

Aufliegende Beschläge, mit Zwangssteuerung MZ
Top mounted fittings, with force control

Zulässige Flügelgrößen
Admissible sash sizes

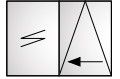

Profile
Profiles

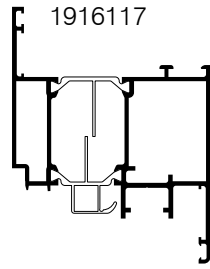

1916118 *

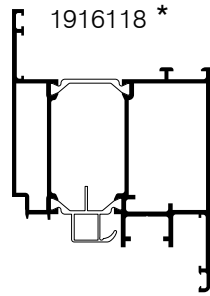

	(Pa)	800	1200	2000	-	-	-	-	-	-	-	-	-	-	-	-
	(Pa)	150	300	600	-	-	-	-	-	-	-	-	-	-	-	-
Flügelgröße Sash size	max.	FAB (m)	2.0	1.8	1.6	-	-	-	-	-	-	-	-	-	-	-
		FAH (m)	2.7	2.7	2.7	-	-	-	-	-	-	-	-	-	-	-
	min.	FAB (m)	1.085	1.085	1.085	-	-	-	-	-	-	-	-	-	-	-
		FAH (m)	0.935	0.935	0.935	-	-	-	-	-	-	-	-	-	-	-
MV / MB	FAB (m)	-	-	-	-	-	-	-	-	-	-	-	-	-	-	-
	FAH (m)	-	-	-	-	-	-	-	-	-	-	-	-	-	-	-
	min.	FAB (m)	-	-	-	-	-	-	-	-	-	-	-	-	-	-
		FAH (m)	-	-	-	-	-	-	-	-	-	-	-	-	-	-
	min.	FAB (m)	-	-	-	-	-	-	-	-	-	-	-	-	-	-
		FAH (m)	-	-	-	-	-	-	-	-	-	-	-	-	-	-
	max. (kg)	200														

* für Einsatz von PZ-Getriebe DM 40
* for use of PZ gear DM 40



FAH ≤ 2 x FAB

WICLINE 75

Aufliegende Beschläge
Top mounted fittings

Zulässige Flügelgrößen
Admissible sash sizes



Profile
Profiles

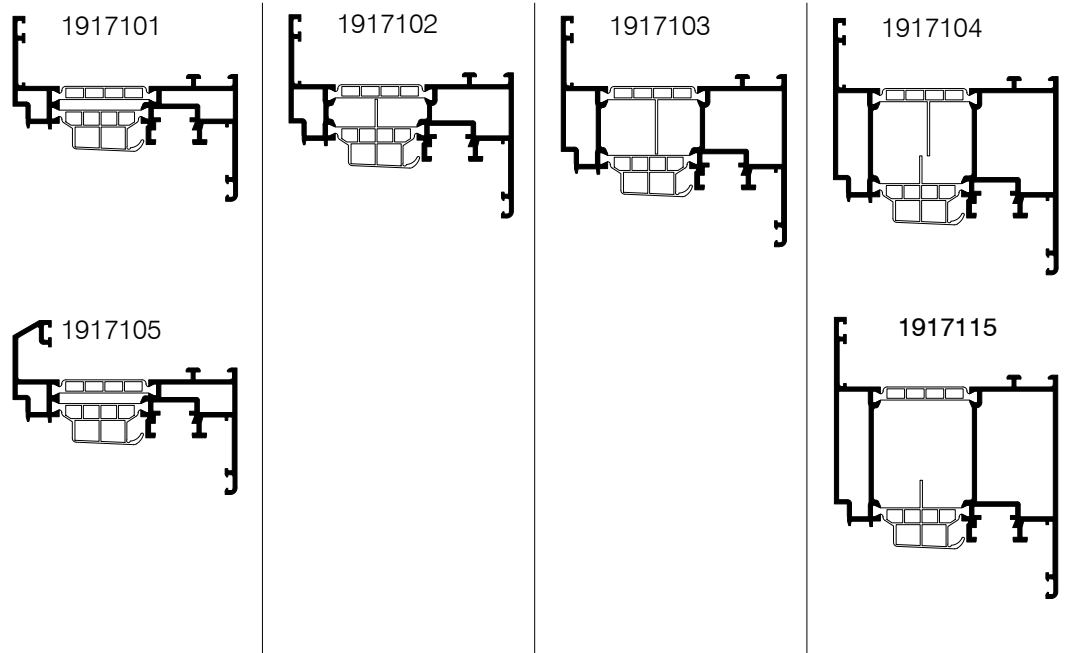

	(Pa)	800	1200	2000	-	800	1200	2000	2000	800	1200	2000	2000*	800	1200	2000*	-		
	(Pa)	150	300	600	-	150	300	600	600	150	300	600	600	150	300	600	-		
Flügelgröße Sash size	max.	FAB (m)	1.3	1.2	1.1	-	1.6	1.5	1.4	1.0	1.6	1.6	1.5	1.0	1.7	1.7	1.6	-	
		FAH (m)	1.7	1.7	1.7	-	2.0	2.0	2.0	2.25	2.25	2.25	2.25	2.5	2.5	2.5	2.5	-	
	min.	FAB (m)	0.45	0.45	0.45	-	0.45	0.45	0.45	0.45	0.45	0.45	0.45	0.45	0.45	0.45	0.45	0.45	-
		FAH (m)	0.6	0.6	0.6	-	0.6	0.6	0.6	0.6	0.6	0.6	0.6	0.6	0.6	0.6	0.6	0.6	-
MV / MB	FAB (m)	-	-	-	-	-	-	1.3	-	-	-	1.3	-	-	-	1.3	-		
	FAH (m)	1.5	1.5	1.3	-	1.7	1.6	1.5	1.5	1.8	1.7	1.6	1.5*	1.8	1.7	1.6*	-		
	max.	FAB (m)	1.3	1.2	1.1	-	1.6	1.5	1.4	1.0	1.6	1.6	1.5	1.0	1.7	1.7	1.6	-	
		FAH (m)	1.7	1.7	1.7	-	2.0	2.0	2.0	2.25	2.1	2.1	2.1	2.25	2.25	2.25	2.25	-	
	min.	FAB (m)	0.45	0.45	0.45	-	0.45	0.45	0.45	0.45	0.45	0.45	0.45	0.45	0.45	0.45	0.45	-	
		FAH (m)	0.83	0.83	0.83	-	0.83	0.83	0.83	0.83	0.83	0.83	0.83	0.83	0.83	0.83	0.83	-	
	min.	FAB (m)	0.65	0.65	0.65	-	0.65	0.65	0.65	0.65	0.65	0.65	0.65	0.65	0.65	0.65	0.65	-	
		FAH (m)	0.9	0.9	0.9	-	0.9	0.9	0.9	0.9	0.9	0.9	0.9	0.9	0.9	0.9	0.9	-	
	max. (kg)	100 (Klotzabst. 50 mm zur Ecke) (Shim dist. to corner 50 mm)				160 (siehe Beschläge "zulässige Formatgrößen") (see fittings "Admissible format sizes")													

* Windlast > 1600 Pa und FAH > 2.25 m werden zwei vertikale Zusatzverriegelungen benötigt

* Wind load > 1600 Pa and FAH 2.25 m requires two vertical additional locking points

WICLINE 75

Aufliegende Beschläge
Top mounted fittings

Zulässige Flügelgrößen
Admissible sash sizes



Profile
Profiles

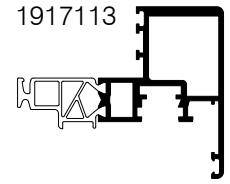
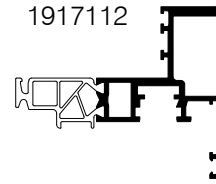
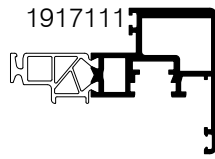
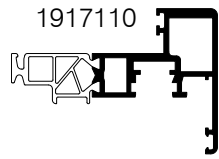

	(Pa)	800	1200	2000	-	800	1200	2000	-	800	1200	2000	-	800	1200	2000	-	
	(Pa)	150	300	600	-	150	300	600	-	150	300	600	-	150	300	600	-	
Flügelgröße Sash size	max.	FAB (m)	1.2	1.1	1.0	-	1.3	1.2	1.1	-	1.4	1.3	1.2	-	1.4	1.4	1.3	-
		FAH (m)	1.4	1.4	1.4	-	1.6	1.6	1.6	-	1.7	1.7	1.7	-	1.8	1.8	1.8	-
	min.	FAB (m)	0.45	0.45	0.45	-	0.45	0.45	0.45	-	0.45	0.45	0.45	-	0.45	0.45	0.45	-
		FAH (m)	0.6	0.6	0.6	-	0.6	0.6	0.6	-	0.6	0.6	0.6	-	0.6	0.6	0.6	-
MV / MB	FAB (m)	-	-	-	-	-	-	-	-	-	-	-	-	-	-	-	-	
	FAH (m)	1.3	1.2	1.1	-	1.4	1.3	1.2	-	1.5	1.4	1.3	-	1.5	1.5	1.4	-	
	max.	FAB (m)	-	-	-	-	-	-	-	-	-	-	-	-	-	-	-	
		FAH (m)	-	-	-	-	-	-	-	-	-	-	-	-	-	-	-	
	min.	FAB (m)	0.45	0.45	0.45	-	0.45	0.45	0.45	-	0.45	0.45	0.45	-	0.45	0.45	0.45	-
		FAH (m)	0.83	0.83	0.83	-	0.83	0.83	0.83	-	0.83	0.83	0.83	-	0.83	0.83	0.83	-
	min.	FAB (m)	0.65	0.65	0.65	-	0.65	0.65	0.65	-	0.65	0.65	0.65	-	0.65	0.65	0.65	-
		FAH (m)	0.9	0.9	0.9	-	0.9	0.9	0.9	-	0.9	0.9	0.9	-	0.9	0.9	0.9	-
	max.(kg)	80				100				100				100				

WICLINE 75

Aufliegende Beschläge
Top mounted fittings

Zulässige Flügelgrößen
Admissible sash sizes



Profile Profiles		1917112				1917113												
	(Pa)	800	1200	2000	-	800	1200	2000	-									
	(Pa)	150	300	600	-	150	300	600	-									
Flügelgröße Sash size	max.	FAB (m)	1.4	1.3	1.2	-	1.4	1.4	1.3	-								
		FAH (m)	1.8	2.0	2.1	-	2.0	2.0	2.25	-								
	min.	FAB (m)	0.45	0.45	0.45	-	0.45	0.45	0.45	-								
		FAH (m)	0.6	0.6	0.6	-	0.6	0.6	0.6	-								
MV / MB	FAB (m)	-	-	-	-	-	-	-	-									
	FAH (m)	1.5	1.4	1.3	-	1.5	1.5	1.4	-									
	max.	FAB (m)	-	-	-	-	-	-	-	-								
		FAH (m)	-	-	-	-	-	-	-	-								
	min.	FAB (m)	0.45	0.45	0.45	-	0.45	0.45	0.45	-								
		FAH (m)	0.83	0.83	0.83	-	0.83	0.83	0.83	-								
	min.	FAB (m)	0.65	0.65	0.65	-	0.65	0.65	0.65	-								
		FAH (m)	0.9	0.9	0.9	-	0.9	0.9	0.9	-								
	max. (kg)	130***				130***												

*** Zusätzliche Verklebung, Angaben in den Verarbeitungsrichtlinien beachten!
*** Additional gluing, pay attention to specifications in the workshop manual!

WICLINE 75

Aufliegende Beschläge
Top mounted fittings

Zulässige Flügelgrößen
Admissible sash sizes



Profile
Profiles

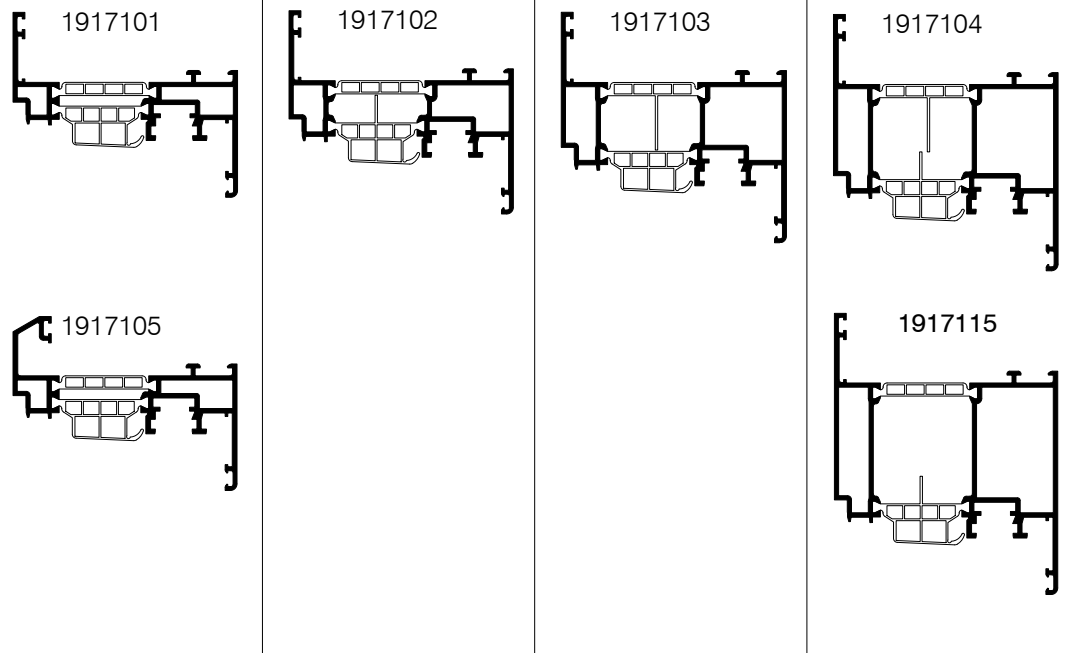

1917121
Stulpaufsatzprofil
mit **Stulpgetriebe**
Double casement
supplement profile with
double casement gear

	(Pa) (m ²)**	800	1200	1600 (1.5)**	-	800	1200	1600 (1.7)**	1600 (1.7)**	800	1200	1600 (1.8)**	1600* (1.8)**	800	1200	1600* (2.0)**	-		
	(Pa)	150	300	600	-	150	300	600	600	150	300	600	600	150	300	450	-		
Flügelgröße Sash size	max.	FAB (m)	1.3	1.2	1.1	-	1.6	1.5	1.4	1.0	1.6	1.6	1.5	1.0	1.7	1.7	1.6	-	
		FAH (m)	1.7	1.7	1.7	-	2.0	2.0	2.0	2.25	2.25	2.25	2.25	2.5	2.5	2.5	2.5	-	
	min.	FAB (m)	0.45	0.45	0.45	-	0.45	0.45	0.45	0.45	0.45	0.45	0.45	0.45	0.45	0.45	0.45	0.45	-
		FAH (m)	0.68	0.68	0.68	-	0.68	0.68	0.68	0.68	0.68	0.68	0.68	0.68	0.68	0.68	0.68	0.68	-
MV / MB	FAB (m)	-	-	-	-	-	-	1.3	-	1.3	1.3	1.3	-	1.3	1.3	1.3	-		
	FAH (m)	1.5	1.5	1.3	-	1.7	1.6	1.5	1.5	1.8	1.7	1.6	1.5*	1.8	1.7	1.6*	-		
	max.	FAB (m)	1.3	1.2	1.1	-	1.2	1.2	1.2	1.0	1.6	1.6	1.5	1.0	1.7	1.7	1.6	-	
		FAH (m)	1.7	1.7	1.7	-	2.0	2.0	2.0	2.25	2.1	2.1	2.1	2.25	2.25	2.25	2.25	-	
	min.	FAB (m)	0.65	0.65	0.65	-	0.65	0.65	0.65	0.65	0.65	0.65	0.65	0.65	0.65	0.65	0.65	-	
		FAH (m)	1.05	1.05	1.05	-	1.05	1.05	1.05	1.05	1.05	1.05	1.05	1.05	1.05	1.05	1.05	-	
	min.	FAB (m)	0.65	0.65	0.65	-	0.65	0.65	0.65	0.65	0.65	0.65	0.65	0.65	0.65	0.65	0.65	-	
		FAH (m)	1.12	1.12	1.12	-	1.12	1.12	1.12	1.12	1.12	1.12	1.12	1.12	1.12	1.12	1.12	-	
	max. (kg)	100 (Klotzabst. 50 mm zur Ecke) (Shim dist. to corner 50 mm)				160 (siehe Beschläge "zulässige Formatgrößen") (see fittings "Admissible format sizes")													

* Windlast > 1200 Pa und FAH > 2.25 m werden zwei vertikale Zusatzverriegelungen benötigt
* Wind load > 1200 Pa and FAH 2.25 m requires two vertical additional locking points

** Flügelgröße > () m² benötigt eine horizontale Zusatzverriegelung
** Sash size > () m² requires a horizontal additional locking point

WICLINE 75

Aufliegende Beschläge
Top mounted fittings

Zulässige Flügelgrößen
Admissible sash sizes



Profile
Profiles

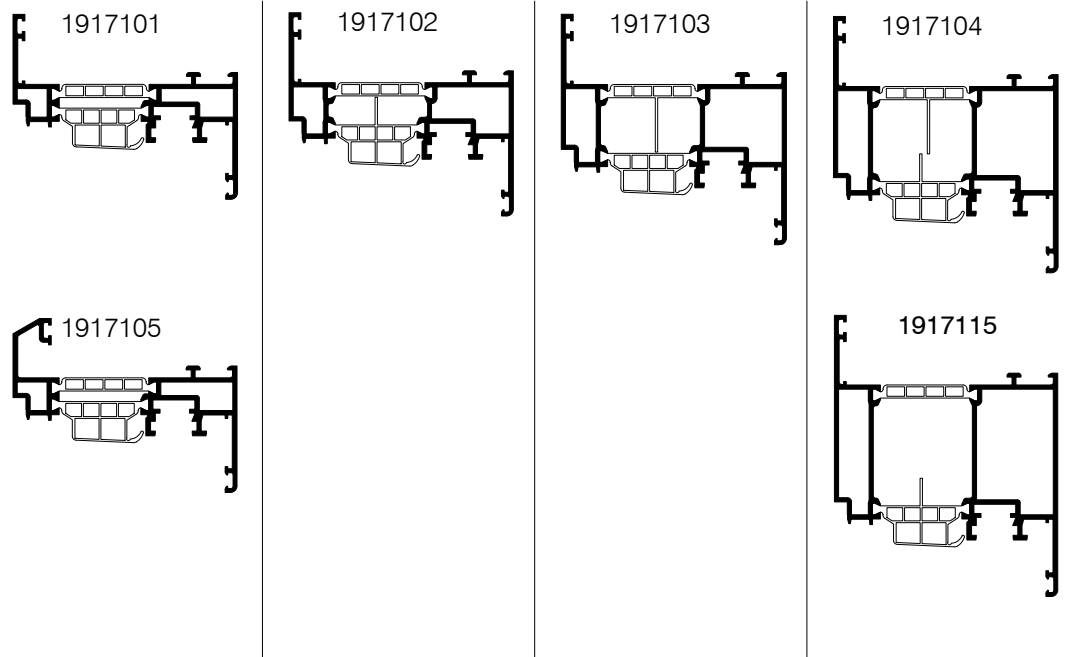

(Pa)
(m²)**

800	1200	1600 (1.5)**	-	800	1200	1600 (1.7)**	1600 (1.7)**	800	1200	1600 (1.8)**	1600 (1.8)**	800	1200	1600 (2.0)**	-
-----	------	-----------------	---	-----	------	-----------------	-----------------	-----	------	-----------------	-----------------	-----	------	-----------------	---



(Pa)

150	300	600	-	150	300	600	600	150	300	600	600	150	300	600	-
-----	-----	-----	---	-----	-----	-----	-----	-----	-----	-----	-----	-----	-----	-----	---

Flügelgröße
Sash size

max.	FAB (m)	1.2	1.2	1.2	-	1.3	1.3	1.3	1.0	1.3	1.3	1.3	1.0	1.3	1.3	1.3	-	
	FAH (m)	1.7	1.6	1.5	-	1.9	1.8	1.7	2.25	2.0	1.9	1.7	2.25	2.25	2.25	2.25	-	
	min.	FAB (m)	0.45	0.45	0.45	-	0.45	0.45	0.45	0.45	0.45	0.45	0.45	0.45	0.45	0.45	0.45	-
		FAH (m)	0.72	0.72	0.72	-	0.72	0.72	0.72	0.72	0.72	0.72	0.72	0.72	0.72	0.72	0.72	-

MV / MB

FAB (m)	-	-	-	-	-	-	-	-	-	-	-	-	-	-	-	-	-
FAH (m)	1.5	1.5	1.3	-	1.7	1.6	1.5	1.5	1.8	1.7	1.6	1.5	1.8	1.7	1.6	-	-



max.	FAB (m)	-	-	-	-	-	-	-	-	-	-	-	-	-	-	-	-
	FAH (m)	-	-	-	-	-	-	-	-	-	-	-	-	-	-	-	-

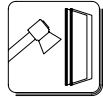

min.	FAB (m)	-	-	-	-	-	-	-	-	-	-	-	-	-	-	-	-
	FAH (m)	-	-	-	-	-	-	-	-	-	-	-	-	-	-	-	-



min.	FAB (m)	-	-	-	-	-	-	-	-	-	-	-	-	-	-	-	-
	FAH (m)	-	-	-	-	-	-	-	-	-	-	-	-	-	-	-	-



max. (kg)		100 (Klotzabst. 50 mm zur Ecke) (Shim dist. to corner 50 mm)				160 (siehe Beschläge "zulässige Formatgrößen") (see fittings "Admissible format sizes")											
-----------	--	--	--	--	--	---	--	--	--	--	--	--	--	--	--	--	--

** Flügelgröße > () m² benötigt eine horizontale Zusatzverriegelung am Gehflügel
** Sash size > () m² requires a horizontal additional locking point in active leaf

WICLINE 75

Aufliegende Beschläge
Top mounted fittings

Zulässige Flügelgrößen
Admissible sash sizes



Profile
Profiles

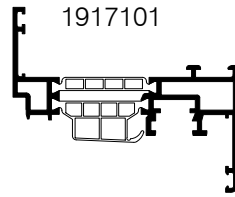

Profile
Profiles

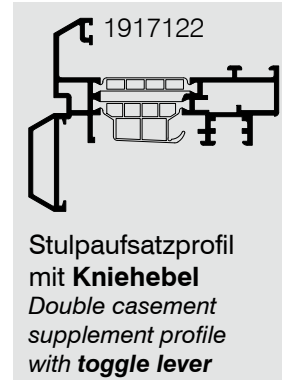
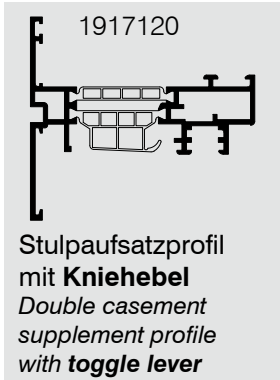
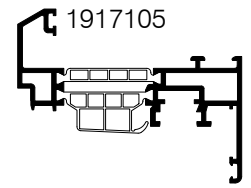

	(Pa)	800	1200	-	-	
	(Pa)	300	600	-	-	
Flügelgröße Sash size	max.	FAB (m)	1.2	1.2	-	-
		FAH (m)	1.6	1.5	-	-
	min.	FAB (m)	0.45	0.45	-	-
		FAH (m)	0.72	0.72	-	-
MV / MB	max.	FAB (m)	-	-	-	-
		FAH (m)	1.4	1.3	-	-
	min.	FAB (m)	-	-	-	-
		FAH (m)	-	-	-	-
	min.	FAB (m)	-	-	-	-
		FAH (m)	-	-	-	-
	max.	FAB (m)	-	-	-	-
		FAH (m)	-	-	-	-
	max. (kg)	100 (Klotzabst. 50 mm zur Ecke) (Shim dist. to corner 50 mm)				

	(Pa)	800	1200	-	-	
	(Pa)	300	600	-	-	
Flügelgröße Sash size	max.	FAB (m)	1.2	1.2	-	-
		FAH (m)	1.6	1.5	-	-
	min.	FAB (m)	0.45	0.45	-	-
		FAH (m)	0.72	0.72	-	-
MV / MB	max.	FAB (m)	-	-	-	-
		FAH (m)	1.4	1.3	-	-
	min.	FAB (m)	-	-	-	-
		FAH (m)	-	-	-	-
	min.	FAB (m)	-	-	-	-
		FAH (m)	-	-	-	-
	max.	FAB (m)	-	-	-	-
		FAH (m)	-	-	-	-
	max. (kg)	100 (Klotzabst. 50 mm zur Ecke) (Shim dist. to corner 50 mm)				

WICLINE 75

Aufliegende Beschläge
Top mounted fittings

Zulässige Flügelgrößen
Admissible sash sizes



Profile
Profiles

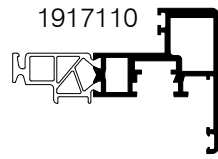

Profile
Profiles

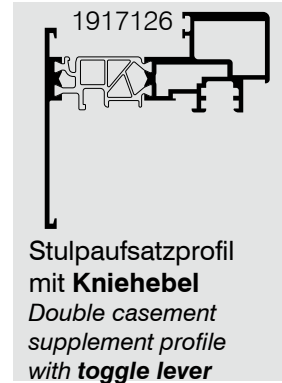
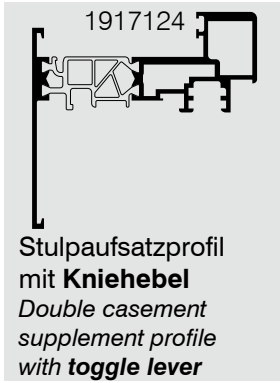
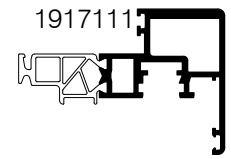

	(Pa)	400	800	1200	-	
	(Pa)	150	300	600	-	
Flügelgröße Sash size	max.	FAB (m)	1.2	1.1	1.0	-
		FAH (m)	1.4	1.4	1.3	-
	min.	FAB (m)	0.45	0.45	0.45	-
		FAH (m)	0.72	0.72	0.72	-
MV / MB	max.	FAB (m)	-	-	-	-
		FAH (m)	1.3	1.2	1.1	-
	min.	FAB (m)	-	-	-	-
		FAH (m)	-	-	-	-
	min.	FAB (m)	-	-	-	-
		FAH (m)	-	-	-	-
	max.	FAB (m)	-	-	-	-
		FAH (m)	-	-	-	-
	max.(kg)	80				

	(Pa)	400	800	1200	-	
	(Pa)	150	300	600	-	
Flügelgröße Sash size	max.	FAB (m)	1.3	1.2	1.1	-
		FAH (m)	1.6	1.6	1.5	-
	min.	FAB (m)	0.45	0.45	0.45	-
		FAH (m)	0.72	0.72	0.72	-
MV / MB	max.	FAB (m)	-	-	-	-
		FAH (m)	1.4	1.3	1.2	-
	min.	FAB (m)	-	-	-	-
		FAH (m)	-	-	-	-
	min.	FAB (m)	-	-	-	-
		FAH (m)	-	-	-	-
	max.	FAB (m)	-	-	-	-
		FAH (m)	-	-	-	-
	max.(kg)	100				

WICLINE 75

Aufliegende Beschläge
Top mounted fittings

Zulässige Flügelgrößen
Admissible sash sizes



Profile
Profiles

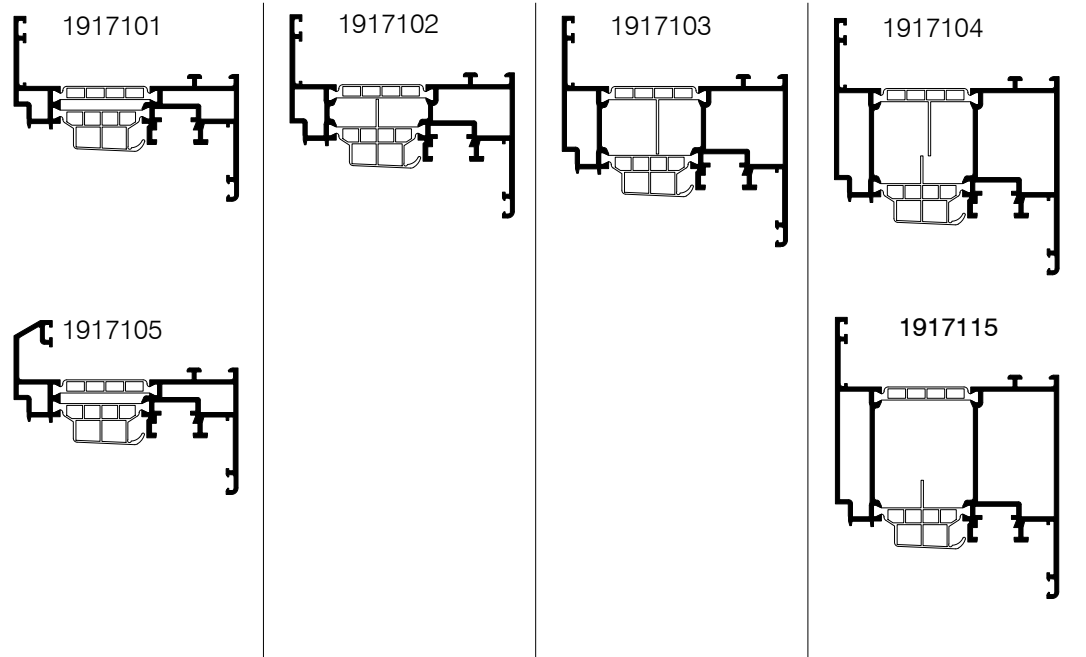

	(Pa)	800	1200	2000	-	800	1200	2000	2000	800	1200	2000	2000*	800	1200	2000*	-		
	(Pa)	150	300	600	-	150	300	600	600	150	300	600	600	150	300	600	-		
Flügelgröße Sash size	max.	FAB (m)	1.3	1.2	1.1	-	1.6	1.5	1.4	1.0	1.6	1.6	1.5	1.0	1.7	1.7	1.6	-	
		FAH (m)	1.7	1.7	1.7	-	2.0	2.0	2.0	2.25	2.25	2.25	2.25	2.5	2.5	2.5	2.5	-	
	min.	FAB (m)	0.425	0.425	0.425	-	0.425	0.425	0.425	0.425	0.425	0.425	0.425	0.425	0.425	0.425	0.425	0.425	-
		FAH (m)	0.7	0.7	0.7	-	0.7	0.7	0.7	0.7	0.7	0.7	0.7	0.7	0.7	0.7	0.7	0.7	-
MV / MB	FAB (m)	-	-	-	-	-	-	1.3	-	-	-	1.3	-	-	-	1.3	-		
	FAH (m)	1.5	1.5	1.3	-	1.7	1.6	1.5	1.5	1.8	1.7	1.6	1.5*	1.8	1.7	1.6*	-		
	max.	FAB (m)	1.3	1.2	1.1	-	1.6	1.5	1.4	1.0	1.6	1.6	1.5	1.0	1.7	1.7	1.6	-	
		FAH (m)	1.7	1.7	1.7	-	2.0	2.0	2.0	2.25	2.1	2.1	2.1	2.25	2.25	2.25	2.25	-	
	min.	FAB (m)	0.425	0.425	0.425	-	0.425	0.425	0.425	0.425	0.425	0.425	0.425	0.425	0.425	0.425	0.425	-	
		FAH (m)	0.7	0.7	0.7	-	0.7	0.7	0.7	0.7	0.7	0.7	0.7	0.7	0.7	0.7	0.7	-	
	min.	FAB (m)	0.68	0.68	0.68	-	0.68	0.68	0.68	0.68	0.68	0.68	0.68	0.68	0.68	0.68	0.68	-	
		FAH (m)	0.9	0.9	0.9	-	0.9	0.9	0.9	0.9	0.9	0.9	0.9	0.9	0.9	0.9	0.9	-	
	max. (kg)	100 (Klotzabst. 50 mm zur Ecke) (Shim dist. to corner 50 mm)				130				130				130					

* Windlast > 1600 Pa und FAH > 2.25 m werden zwei vertikale Zusatzverriegelungen benötigt







* Wind load > 1600 Pa and FAH 2.25 m requires two vertical additional locking points

WICLINE 75

Aufliegende Beschläge
Top mounted fittings

Zulässige Flügelgrößen
Admissible sash sizes



Profile Profiles		1917110				1917111				1917112				1917113				
	(Pa)	800	1200	2000	-	800	1200	2000	-	800	1200	2000	-	800	1200	2000	-	
	(Pa)	150	300	600	-	150	300	600	-	150	300	600	-	150	300	600	-	
Flügelgröße Sash size	max.	FAB (m)	1.2	1.1	1.0	-	1.3	1.2	1.1	-	1.4	1.3	1.2	-	1.4	1.4	1.3	-
		FAH (m)	1.4	1.4	1.4	-	1.6	1.6	1.6	-	1.7	1.7	1.7	-	1.8	1.8	1.8	-
	min.	FAB (m)	0.425	0.425	0.425	-	0.425	0.425	0.425	-	0.425	0.425	0.425	-	0.425	0.425	0.425	-
		FAH (m)	0.7	0.7	0.7	-	0.7	0.7	0.7	-	0.7	0.7	0.7	-	0.7	0.7	0.7	-
MV / MB	FAB (m)	-	-	-	-	-	-	-	-	-	-	-	-	-	-	-	-	
	FAH (m)	1.3	1.2	1.1	-	1.4	1.3	1.2	-	1.5	1.4	1.3	-	1.5	1.5	1.4	-	
 WK3	max.	FAB (m)	1.2	1.1	1.0	-	1.3	1.2	1.1	-	1.4	1.3	1.2	-	1.4	1.4	1.3	-
		FAH (m)	1.4	1.4	1.4	-	1.6	1.6	1.6	-	1.7	1.7	1.7	-	1.8	1.8	1.8	-
	min.	FAB (m)	0.425	0.425	0.425	-	0.425	0.425	0.425	-	0.425	0.425	0.425	-	0.425	0.425	0.425	-
		FAH (m)	0.7	0.7	0.7	-	0.7	0.7	0.7	-	0.7	0.7	0.7	-	0.7	0.7	0.7	-
 WK3	min.	FAB (m)	0.68	0.68	0.68	-	0.68	0.68	0.68	-	0.68	0.68	0.68	-	0.68	0.68	0.68	-
		FAH (m)	0.9	0.9	0.9	-	0.9	0.9	0.9	-	0.9	0.9	0.9	-	0.9	0.9	0.9	-
 max. kg	max.(kg)	80				100				100				100				

WICLINE 75

Aufliegende Beschläge
Top mounted fittings

Zulässige Flügelgrößen
Admissible sash sizes



Profile Profiles		1917112				1917113												
		(Pa)	800	1200	2000	-	800	1200	2000	-								
		(Pa)	150	300	600	-	150	300	600	-								
Flügelgröße Sash size	max.	FAB (m)	1.4	1.3	1.2	-	1.4	1.4	1.3	-								
		FAH (m)	1.8	2.0	2.1	-	2.0	2.0	2.25	-								
	min.	FAB (m)	0.425	0.425	0.425	-	0.425	0.425	0.425	-								
		FAH (m)	0.7	0.7	0.7	-	0.7	0.7	0.7	-								
MV / MB		FAB (m)	-	-	-	-	-	-	-	-								
		FAH (m)	1.5	1.4	1.3	-	1.5	1.5	1.4	-								
	max.	FAB (m)	1.4	1.3	1.2	-	1.4	1.4	1.3	-								
		FAH (m)	1.7	1.7	1.7	-	1.8	1.8	1.8	-								
	min.	FAB (m)	0.425	0.425	0.425	-	0.425	0.425	0.425	-								
		FAH (m)	0.7	0.7	0.7	-	0.7	0.7	0.7	-								
	min.	FAB (m)	0.68	0.68	0.68	-	0.68	0.68	0.68	-								
		FAH (m)	0.9	0.9	0.9	-	0.9	0.9	0.9	-								
	max. (kg)		130***				130***											

*** Zusätzliche Verklebung, Angaben in den Verarbeitungsrichtlinien beachten!
*** Additional gluing, pay attention to specifications in the workshop manual!

WICLINE 75

Aufliegende Beschläge
Top mounted fittings

Zulässige Flügelgrößen
Admissible sash sizes



Profile Profiles		1917101				1917102				1917103				1917104				1917105				1917115					
	(Pa)	800	1200	2000	-	800	1200	2000	2000	800	1200	2000	2000*	800	1200	2000*	-	800	1200	2000	-	800	1200	2000	-		
	(Pa)	150	300	600	-	150	300	600	600	150	300	600	600	150	300	600	600	150	300	600	-	150	300	600	-		
Flügelgröße Sash size	max.	FAB (m)	1.7	1.7	1.7	-	2.0	2.0	2.0	2.25	2.25	2.25	2.25	2.5	2.5	2.5	2.5	2.5	-	2.5	2.5	2.5	-	2.5	2.5	2.5	-
		FAH (m)	1.3	1.2	1.1	-	1.6	1.5	1.4	1.0	1.6	1.6	1.5	1.0	1.7	1.7	1.6	-	1.7	1.7	1.6	-	1.6	1.6	1.6	-	
	min.	FAB (m)	0.6	0.6	0.6	-	0.6	0.6	0.6	0.6	0.6	0.6	0.6	0.6	0.6	0.6	0.6	0.6	-	0.6	0.6	0.6	-	0.6	0.6	0.6	-
		FAH (m)	0.45	0.45	0.45	-	0.45	0.45	0.45	0.45	0.45	0.45	0.45	0.45	0.45	0.45	0.45	0.45	-	0.45	0.45	0.45	-	0.45	0.45	0.45	-
MV / MB	FAB (m)	1.5	1.5	1.3	-	1.7	1.6	1.5	1.5	1.8	1.7	1.6	1.5*	1.8	1.7	1.6*	-	-	1.8	1.7	1.6*	-	1.8	1.7	1.6*	-	
	FAH (m)	-	-	-	-	-	-	1.3	-	-	-	1.3	-	-	-	1.3	-	-	-	-	1.3	-	-	-	1.3	-	
	max.	FAB (m)	1.7	1.7	1.7	-	2.0	2.0	2.0	-	2.1	2.1	2.1	-	2.25	2.25	2.25	-	-	2.25	2.25	2.25	-	2.25	2.25	2.25	-
		FAH (m)	1.3	1.2	1.1	-	1.6	1.5	1.4	-	1.6	1.6	1.5	-	1.7	1.7	1.6	-	-	1.7	1.7	1.6	-	1.6	1.6	1.6	-
	min.	FAB (m)	0.74	0.74	0.74	-	0.74	0.74	0.74	0.74	0.74	0.74	0.74	0.74	0.74	0.74	0.74	0.74	-	0.74	0.74	0.74	-	0.74	0.74	0.74	-
		FAH (m)	0.45	0.45	0.45	-	0.45	0.45	0.45	0.45	0.45	0.45	0.45	0.45	0.45	0.45	0.45	0.45	-	0.45	0.45	0.45	-	0.45	0.45	0.45	-
	min.	FAB (m)	0.9	0.9	0.9	-	0.9	0.9	0.9	0.9	0.9	0.9	0.9	0.9	0.9	0.9	0.9	0.9	-	0.9	0.9	0.9	-	0.9	0.9	0.9	-
		FAH (m)	0.6	0.6	0.6	-	0.6	0.6	0.6	0.6	0.6	0.6	0.6	0.6	0.6	0.6	0.6	0.6	-	0.6	0.6	0.6	-	0.6	0.6	0.6	-
	max. (kg)	100 (Klotzabst. 50 mm zur Ecke) (Shim dist. to corner 50 mm)				130				130				130													







* Windlast > 1600 Pa und FAB > 2.25 m werden zwei horizontale Zusatzverriegelungen benötigt
* Wind load > 1600 Pa and FAB 2.25 m requires two horizontal additional locking points

WICLINE 75

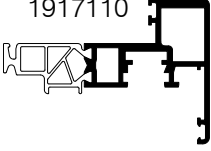
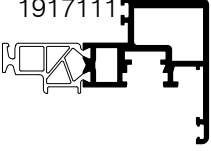
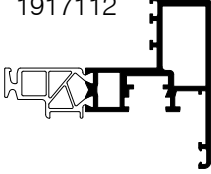
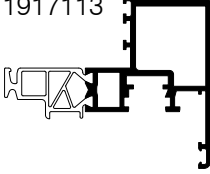
Aufliegende Beschläge
Top mounted fittings

Zulässige Flügelgrößen
Admissible sash sizes



Profile Profiles		1917110 				1917111 				1917112 				1917113 				
	(Pa)	800	1200	2000	-	800	1200	2000	-	800	1200	2000	-	800	1200	2000	-	
	(Pa)	150	300	600	-	150	300	600	-	150	300	600	-	150	300	600	-	
Flügelgröße Sash size	max.	FAB (m)	1.4	1.4	1.4	-	1.6	1.6	1.6	-	1.7	1.7	1.7	-	1.8	1.8	1.8	-
		FAH (m)	1.2	1.1	1.0	-	1.3	1.2	1.1	-	1.4	1.3	1.2	-	1.4	1.4	1.3	-
	min.	FAB (m)	0.6	0.6	0.6	-	0.6	0.6	0.6	-	0.6	0.6	0.6	-	0.6	0.6	0.6	-
		FAH (m)	0.45	0.45	0.45	-	0.45	0.45	0.45	-	0.45	0.45	0.45	-	0.45	0.45	0.45	-
MV / MB	FAB (m)	1.3	1.2	1.1	-	1.4	1.3	1.2	-	1.5	1.4	1.3	-	1.5	1.5	1.4	-	
	FAH (m)	-	-	-	-	-	-	-	-	-	-	-	-	-	-	-	-	
 WK3	max.	FAB (m)	1.4	1.4	1.4	-	1.6	1.6	1.6	-	1.7	1.7	1.7	-	1.8	1.8	1.8	-
		FAH (m)	1.2	1.1	1.0	-	1.3	1.2	1.1	-	1.4	1.3	1.2	-	1.4	1.4	1.3	-
	min.	FAB (m)	0.74	0.74	0.74	-	0.74	0.74	0.74	-	0.74	0.74	0.74	-	0.74	0.74	0.74	-
		FAH (m)	0.45	0.45	0.45	-	0.45	0.45	0.45	-	0.45	0.45	0.45	-	0.45	0.45	0.45	-
 WK3	min.	FAB (m)	0.9	0.9	0.9	-	0.9	0.9	0.9	-	0.9	0.9	0.9	-	0.9	0.9	0.9	-
		FAH (m)	0.6	0.6	0.6	-	0.6	0.6	0.6	-	0.6	0.6	0.6	-	0.6	0.6	0.6	-
 max. kg	max.(kg)	80				100				100				100				

WICLINE 75

Aufliegende Beschläge
Top mounted fittings

Zulässige Flügelgrößen
Admissible sash sizes



Profile Profiles		1917112				1917113												
		(Pa)	800	1200	2000	-	800	1200	2000	-								
		(Pa)	150	300	600	-	150	300	600	-								
Flügelgröße Sash size	max.	FAB (m)	1.8	2.0	2.1	-	2.0	2.0	2.25	-								
		FAH (m)	1.4	1.3	1.2	-	1.4	1.4	1.3	-								
	min.	FAB (m)	0.6	0.6	0.6	-	0.6	0.6	0.6	-								
		FAH (m)	0.45	0.45	0.45	-	0.45	0.45	0.45	-								
MV / MB	FAB (m)	1.5	1.4	1.3	-	1.5	1.5	1.4	-									
	FAH (m)	-	-	-	-	-	-	-	-									
	max.	FAB (m)	1.7	1.7	1.7	-	1.8	1.8	1.8	-								
		FAH (m)	1.4	1.3	1.2	-	1.4	1.4	1.3	-								
	min.	FAB (m)	0.74	0.74	0.74	-	0.74	0.74	0.74	-								
		FAH (m)	0.45	0.45	0.45	-	0.45	0.45	0.45	-								
	min.	FAB (m)	0.9	0.9	0.9	-	0.9	0.9	0.9	-								
		FAH (m)	0.6	0.6	0.6	-	0.6	0.6	0.6	-								
	max. (kg)		130***				130***											

*** Zusätzliche Verklebung, Angaben in den Verarbeitungsrichtlinien beachten!
*** Additional gluing, pay attention to specifications in the workshop manual!

WICLINE 75

Verdeckte Beschläge
Concealed fittings



Zulässige Flügelgrößen
Admissible sash sizes



Profile
Profiles

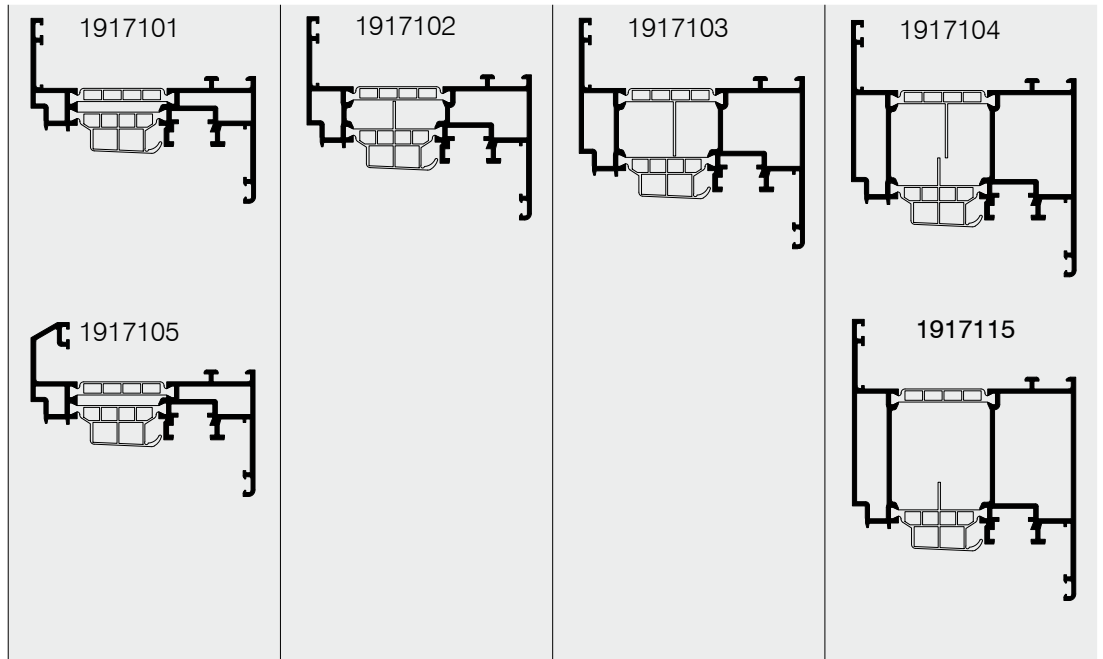

	(Pa)	800	1200	2000	-	800	1200	2000	2000	800	1200	2000	2000*	800	1200	2000*	-		
	(Pa)	150	300	600	-	150	300	600	600	150	300	600	600	150	300	600	-		
Flügelgröße Sash size	max.	FAB (m)	1.3	1.2	1.1	-	1.6	1.5	1.4	1.0	1.6	1.6	1.5	1.0	1.7	1.7	1.6	-	
		FAH (m)	1.7	1.7	1.7	-	2.0	2.0	2.0	2.25	2.25	2.25	2.25	2.5	2.5	2.5	2.5	-	
	min.	FAB (m)	0.45	0.45	0.45	-	0.45	0.45	0.45	0.45	0.45	0.45	0.45	0.45	0.45	0.45	0.45	0.45	-
		FAH (m)	0.6	0.6	0.6	-	0.6	0.6	0.6	0.6	0.6	0.6	0.6	0.6	0.6	0.6	0.6	0.6	-
MV / MB	FAB (m)	-	-	-	-	-	-	1.3	-	-	-	1.3	-	-	-	1.3	-		
	FAH (m)	1.5	1.5	1.3	-	1.7	1.6	1.5	1.5	1.8	1.7	1.6	1.5*	1.8	1.7	1.6*	-		
	max.	FAB (m)	1.3	1.2	1.1	-	1.6	1.5	1.4	1.0	1.6	1.6	1.5	1.0	1.7	1.7	1.6	-	
		FAH (m)	1.7	1.7	1.7	-	2.0	2.0	2.0	2.25	2.1	2.1	2.1	2.25	2.25	2.25	2.25	-	
	min.	FAB (m)	0.45	0.45	0.45	-	0.45	0.45	0.45	0.45	0.45	0.45	0.45	0.45	0.45	0.45	0.45	-	
		FAH (m)	0.83	0.83	0.83	-	0.83	0.83	0.83	0.83	0.83	0.83	0.83	0.83	0.83	0.83	0.83	-	
	min.	FAB (m)	0.65	0.65	0.65	-	0.65	0.65	0.65	0.65	0.65	0.65	0.65	0.65	0.65	0.65	0.65	-	
		FAH (m)	0.9	0.9	0.9	-	0.9	0.9	0.9	0.9	0.9	0.9	0.9	0.9	0.9	0.9	0.9	-	
	max. (kg)	100 (Klotzabst. 50 mm zur Ecke) (Shim dist. to corner 50 mm)				160 (siehe Beschläge "zulässige Formatgrößen") (see fittings "Admissible format sizes")													

* Windlast > 1600 Pa und FAH > 2.25 m werden zwei vertikale Zusatzverriegelungen benötigt

* Wind load > 1600 Pa and FAH 2.25 m requires two vertical additional locking points

WICLINE 75

Verdeckte Beschläge
Concealed fittings



Zulässige Flügelgrößen
Admissible sash sizes



Profile Profiles		1917110				1917111				1917112				1917113				
	(Pa)	800	1200	2000	-	800	1200	2000	-	800	1200	2000	-	800	1200	2000	-	
	(Pa)	150	300	600	-	150	300	600	-	150	300	600	-	150	300	600	-	
Flügelgröße Sash size	max.	FAB (m)	1.2	1.1	1.0	-	1.3	1.2	1.1	-	1.4	1.3	1.2	-	1.4	1.4	1.3	-
		FAH (m)	1.4	1.4	1.4	-	1.6	1.6	1.6	-	1.7	1.7	1.7	-	1.8	1.8	1.8	-
	min.	FAB (m)	0.45	0.45	0.45	-	0.45	0.45	0.45	-	0.45	0.45	0.45	-	0.45	0.45	0.45	-
		FAH (m)	0.6	0.6	0.6	-	0.6	0.6	0.6	-	0.6	0.6	0.6	-	0.6	0.6	0.6	-
MV / MB	FAB (m)	-	-	-	-	-	-	-	-	-	-	-	-	-	-	-	-	
	FAH (m)	1.3	1.2	1.1	-	1.4	1.3	1.2	-	1.5	1.4	1.3	-	1.5	1.5	1.4	-	
	max.	FAB (m)	-	-	-	-	-	-	-	-	-	-	-	-	-	-	-	-
		FAH (m)	-	-	-	-	-	-	-	-	-	-	-	-	-	-	-	-
	min.	FAB (m)	0.45	0.45	0.45	-	0.45	0.45	0.45	-	0.45	0.45	0.45	-	0.45	0.45	0.45	-
		FAH (m)	0.83	0.83	0.83	-	0.83	0.83	0.83	-	0.83	0.83	0.83	-	0.83	0.83	0.83	-
	min.	FAB (m)	0.65	0.65	0.65	-	0.65	0.65	0.65	-	0.65	0.65	0.65	-	0.65	0.65	0.65	-
		FAH (m)	0.9	0.9	0.9	-	0.9	0.9	0.9	-	0.9	0.9	0.9	-	0.9	0.9	0.9	-
	max.(kg)	80				100				100				100				

6

WICLINE 75

Verdeckte Beschläge
Concealed fittings



Zulässige Flügelgrößen
Admissible sash sizes



Profile Profiles		1917112				1917113												
		(Pa)	800	1200	2000	-	800	1200	2000	-								
		(Pa)	150	300	600	-	150	300	600	-								
Flügelgröße Sash size	max.	FAB (m)	1.4	1.3	1.2	-	1.4	1.4	1.3	-								
		FAH (m)	1.8	2.0	2.1	-	2.0	2.0	2.25	-								
	min.	FAB (m)	0.45	0.45	0.45	-	0.45	0.45	0.45	-								
		FAH (m)	0.6	0.6	0.6	-	0.6	0.6	0.6	-								
MV / MB	FAB (m)	-	-	-	-	-	-	-	-									
	FAH (m)	1.5	1.4	1.3	-	1.5	1.5	1.4	-									
	max.	FAB (m)	-	-	-	-	-	-	-	-								
		FAH (m)	-	-	-	-	-	-	-	-								
	min.	FAB (m)	0.45	0.45	0.45	-	0.45	0.45	0.45	-								
		FAH (m)	0.83	0.83	0.83	-	0.83	0.83	0.83	-								
	min.	FAB (m)	0.65	0.65	0.65	-	0.65	0.65	0.65	-								
		FAH (m)	0.9	0.9	0.9	-	0.9	0.9	0.9	-								
	max. (kg)		130***				130***											

*** Zusätzliche Verklebung, Angaben in den Verarbeitungsrichtlinien beachten!
*** Additional gluing, pay attention to specifications in the workshop manual!







WICLINE 75

Verdeckte Beschläge
Concealed fittings

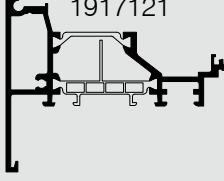
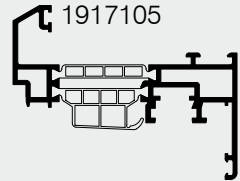
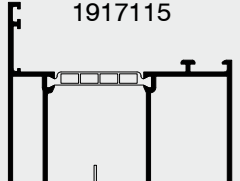

Zulässige Flügelgrößen
Admissible sash sizes



Profile Profiles		1917101				1917102				1917103				1917104				
 1917121 Stulpaufsatzprofil mit Stulpgetriebe Double casement supplement profile with double casement gear		 1917105												 1917115				
	(Pa) (m ²)**	800	1200	1600 (1.5)**	-	800	1200	1600 (1.7)**	1600 (1.7)**	800	1200	1600 (1.8)**	1600* (1.8)**	800	1200	1600* (2.0)**	-	
	(Pa)	150	300	600	-	150	300	600	600	150	300	600	600	150	300	450	-	
Flügelgröße Sash size	max.	FAB (m)	1.3	1.2	1.1	-	1.6	1.5	1.4	1.0	1.6	1.6	1.5	1.0	1.7	1.7	1.6	-
		FAH (m)	1.7	1.7	1.7	-	2.0	2.0	2.0	2.25	2.25	2.25	2.25	2.5	2.5	2.5	2.5	-
	min.	FAB (m)	0.45	0.45	0.45	-	0.45	0.45	0.45	0.45	0.45	0.45	0.45	0.45	0.45	0.45	0.45	-
		FAH (m)	0.68	0.68	0.68	-	0.68	0.68	0.68	0.68	0.68	0.68	0.68	0.68	0.68	0.68	0.68	-
MV / MB	FAB (m)	-	-	-	-	-	-	1.3	-	1.3	1.3	1.3	-	1.3	1.3	1.3	-	
	FAH (m)	1.5	1.5	1.3	-	1.7	1.6	1.5	1.5	1.8	1.7	1.6	1.5*	1.8	1.7	1.6*	-	
	max.	FAB (m)	1.3	1.2	1.1	-	1.2	1.2	1.2	1.0	1.6	1.6	1.5	1.0	1.7	1.7	1.6	-
		FAH (m)	1.7	1.7	1.7	-	2.0	2.0	2.0	2.25	2.1	2.1	2.1	2.25	2.25	2.25	2.25	-
	min.	FAB (m)	0.65	0.65	0.65	-	0.65	0.65	0.65	0.65	0.65	0.65	0.65	0.65	0.65	0.65	0.65	-
		FAH (m)	1.05	1.05	1.05	-	1.05	1.05	1.05	1.05	1.05	1.05	1.05	1.05	1.05	1.05	1.05	-
	min.	FAB (m)	0.65	0.65	0.65	-	0.65	0.65	0.65	0.65	0.65	0.65	0.65	0.65	0.65	0.65	0.65	-
		FAH (m)	1.12	1.12	1.12	-	1.12	1.12	1.12	1.12	1.12	1.12	1.12	1.12	1.12	1.12	1.12	-
	max. (kg)	100 (Klotzabst. 50 mm zur Ecke) (Shim dist. to corner 50 mm)				160 (siehe Beschläge "zulässige Formatgrößen") (see fittings "Admissible format sizes")												

* Windlast > 1200 Pa und FAH > 2.25 m werden zwei vertikale Zusatzverriegelungen benötigt
* Wind load > 1200 Pa and FAH 2.25 m requires two vertical additional locking points

** Flügelgröße > () m² benötigt eine horizontale Zusatzverriegelung
** Sash size > () m² requires a horizontal additional locking point







WICLINE 75

Verdeckte Beschläge
Concealed fittings

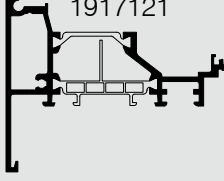

Zulässige Flügelgrößen
Admissible sash sizes



Profile Profiles		1917101				1917102				1917103				1917104				
		1917121				1917105								1917115				
Stulpaufsatzprofil mit Kniehebel Double casement supplement profile with toggle lever																		
	(Pa) (m ²)**	800	1200	1600 (1.5)**	-	800	1200	1600 (1.7)**	1600 (1.7)**	800	1200	1600 (1.8)**	1600 (1.8)**	800	1200	1600 (2.0)**	-	
	(Pa)	150	300	600	-	150	300	600	600	150	300	600	600	150	300	600	-	
Flügelgröße Sash size	max.	FAB (m)	1.2	1.2	1.2	-	1.3	1.3	1.3	1.0	1.3	1.3	1.3	1.0	1.3	1.3	1.3	-
		FAH (m)	1.7	1.6	1.5	-	1.9	1.8	1.7	2.25	2.0	1.9	1.7	2.25	2.25	2.25	2.25	-
	min.	FAB (m)	0.45	0.45	0.45	-	0.45	0.45	0.45	0.45	0.45	0.45	0.45	0.45	0.45	0.45	0.45	-
		FAH (m)	0.72	0.72	0.72	-	0.72	0.72	0.72	0.72	0.72	0.72	0.72	0.72	0.72	0.72	0.72	-
MV / MB	FAB (m)	-	-	-	-	-	-	-	-	-	-	-	-	-	-	-	-	
	FAH (m)	1.5	1.5	1.3	-	1.7	1.6	1.5	1.5	1.8	1.7	1.6	1.5	1.8	1.7	1.6	-	
	max.	FAB (m)	-	-	-	-	-	-	-	-	-	-	-	-	-	-	-	-
		FAH (m)	-	-	-	-	-	-	-	-	-	-	-	-	-	-	-	-
	min.	FAB (m)	-	-	-	-	-	-	-	-	-	-	-	-	-	-	-	-
		FAH (m)	-	-	-	-	-	-	-	-	-	-	-	-	-	-	-	-
	min.	FAB (m)	-	-	-	-	-	-	-	-	-	-	-	-	-	-	-	-
		FAH (m)	-	-	-	-	-	-	-	-	-	-	-	-	-	-	-	-
	max. (kg)	100 (Klotzabst. 50 mm zur Ecke) (Shim dist. to corner 50 mm)				160 (siehe Beschläge "zulässige Formatgrößen") (see fittings "Admissible format sizes")												

** Flügelgröße > () m² benötigt eine horizontale Zusatzverriegelung am Gehflügel
** Sash size > () m² requires a horizontal additional locking point in active leaf

WICLINE 75

Verdeckte Beschläge
Concealed fittings



Zulässige Flügelgrößen Admissible sash sizes



Profile
Profiles

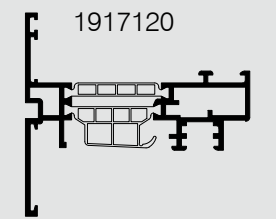
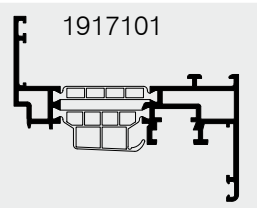

Stulpaufsatzprofil
mit **Kniehebel**
Double casement
supplement profile
with **toggle lever**

	(Pa)	800	1200	-	-	
	(Pa)	300	600	-	-	
Flügelgröße Sash size	max.	FAB (m)	1.2	1.2	-	-
		FAH (m)	1.6	1.5	-	-
	min.	FAB (m)	0.45	0.45	-	-
		FAH (m)	0.72	0.72	-	-
MV / MB	max.	FAB (m)	-	-	-	-
		FAH (m)	1.4	1.3	-	-
	min.	FAB (m)	-	-	-	-
		FAH (m)	-	-	-	-
	min.	FAB (m)	-	-	-	-
		FAH (m)	-	-	-	-
	max.	FAB (m)	-	-	-	-
		FAH (m)	-	-	-	-
	max. (kg)	100 (Klotzabst. 50 mm zur Ecke) (Shim dist. to corner 50 mm)				

Profile
Profiles

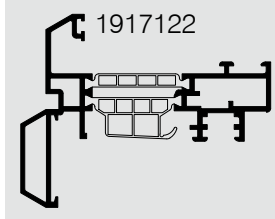
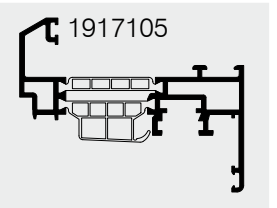

Stulpaufsatzprofil
mit **Kniehebel**
Double casement
supplement profile
with **toggle lever**

	(Pa)	800	1200	-	-	
	(Pa)	300	600	-	-	
Flügelgröße Sash size	max.	FAB (m)	1.2	1.2	-	-
		FAH (m)	1.6	1.5	-	-
	min.	FAB (m)	0.45	0.45	-	-
		FAH (m)	0.72	0.72	-	-
MV / MB	max.	FAB (m)	-	-	-	-
		FAH (m)	1.4	1.3	-	-
	min.	FAB (m)	-	-	-	-
		FAH (m)	-	-	-	-
	min.	FAB (m)	-	-	-	-
		FAH (m)	-	-	-	-
	max.	FAB (m)	-	-	-	-
		FAH (m)	-	-	-	-
	max. (kg)	100 (Klotzabst. 50 mm zur Ecke) (Shim dist. to corner 50 mm)				

WICLINE 75

Verdeckte Beschläge
Concealed fittings



Zulässige Flügelgrößen Admissible sash sizes



Profile
Profiles

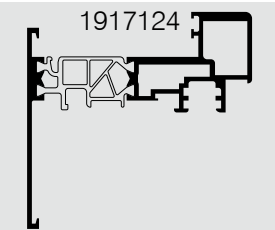
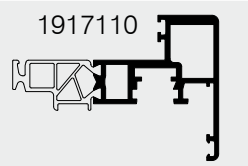

Stulpaufsatzprofil
mit **Kniehebel**
Double casement
supplement profile
with **toggle lever**

	(Pa)	400	800	1200	-	
	(Pa)	150	300	600	-	
Flügelgröße Sash size	max.	FAB (m)	1.2	1.1	1.0	-
		FAH (m)	1.4	1.4	1.3	-
	min.	FAB (m)	0.45	0.45	0.45	-
		FAH (m)	0.72	0.72	0.72	-
MV / MB	max.	FAB (m)	-	-	-	-
		FAH (m)	1.3	1.2	1.1	-
	min.	FAB (m)	-	-	-	-
		FAH (m)	-	-	-	-
	min.	FAB (m)	-	-	-	-
		FAH (m)	-	-	-	-
	max.	FAB (m)	-	-	-	-
		FAH (m)	-	-	-	-
	max.(kg)	80				

Profile
Profiles

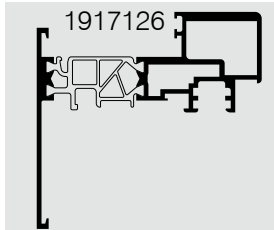
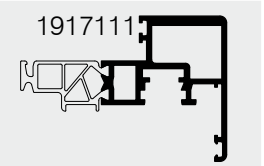

Stulpaufsatzprofil
mit **Kniehebel**
Double casement
supplement profile
with **toggle lever**

	(Pa)	400	800	1200	-	
	(Pa)	150	300	600	-	
Flügelgröße Sash size	max.	FAB (m)	1.3	1.2	1.1	-
		FAH (m)	1.6	1.6	1.5	-
	min.	FAB (m)	0.45	0.45	0.45	-
		FAH (m)	0.72	0.72	0.72	-
MV / MB	max.	FAB (m)	-	-	-	-
		FAH (m)	1.4	1.3	1.2	-
	min.	FAB (m)	-	-	-	-
		FAH (m)	-	-	-	-
	min.	FAB (m)	-	-	-	-
		FAH (m)	-	-	-	-
	max.	FAB (m)	-	-	-	-
		FAH (m)	-	-	-	-
	max.(kg)	100				

WICLINE 75

Verdeckte Beschläge
Concealed fittings



Zulässige Flügelgrößen
Admissible sash sizes



Profile
Profiles

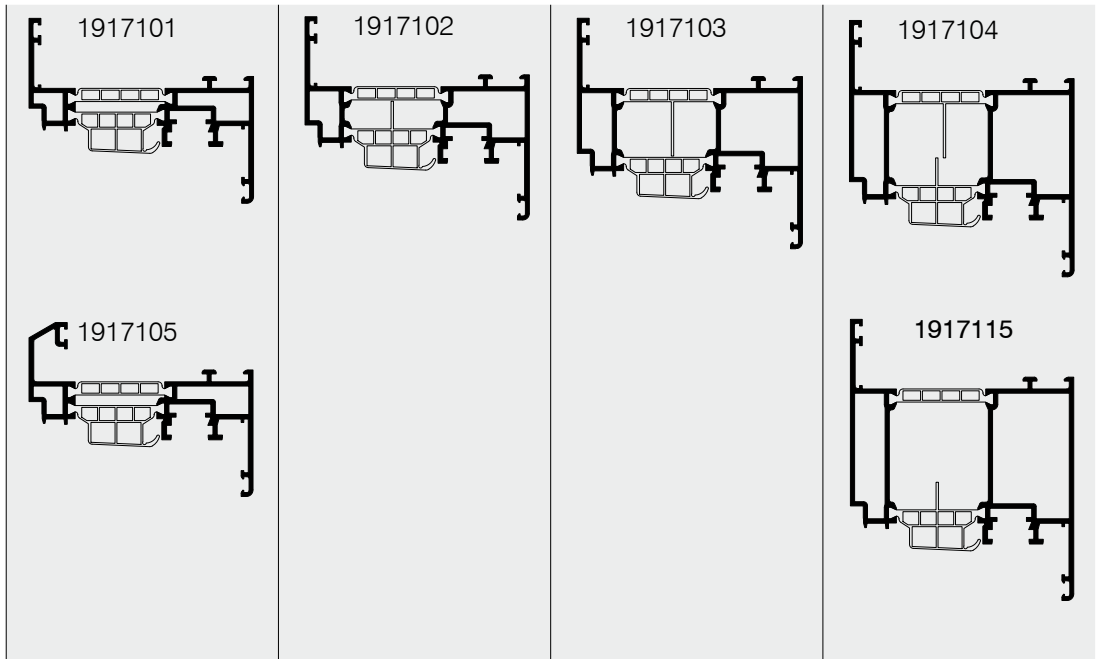

	(Pa)	800	1200	2000	-	800	1200	2000	2000	800	1200	2000	2000*	800	1200	2000*	-		
	(Pa)	150	300	600	-	150	300	600	600	150	300	600	600	150	300	600	-		
Flügelgröße Sash size	max.	FAB (m)	1.3	1.2	1.1	-	1.6	1.5	1.4	1.0	1.6	1.6	1.5	1.0	1.7	1.7	1.6	-	
		FAH (m)	1.7	1.7	1.7	-	2.0	2.0	2.0	2.25	2.25	2.25	2.25	2.5	2.5	2.5	2.5	-	
	min.	FAB (m)	0.425	0.425	0.425	-	0.425	0.425	0.425	0.425	0.425	0.425	0.425	0.425	0.425	0.425	0.425	0.425	-
		FAH (m)	0.7	0.7	0.7	-	0.7	0.7	0.7	0.7	0.7	0.7	0.7	0.7	0.7	0.7	0.7	0.7	-
MV / MB	FAB (m)	-	-	-	-	-	-	1.3	-	-	-	1.3	-	-	-	1.3	-		
	FAH (m)	1.5	1.5	1.3	-	1.7	1.6	1.5	1.5	1.8	1.7	1.6	1.5*	1.8	1.7	1.6*	-		
	max.	FAB (m)	1.3	1.2	1.1	-	1.6	1.5	1.4	1.0	1.6	1.6	1.5	1.0	1.7	1.7	1.6	-	
		FAH (m)	1.7	1.7	1.7	-	2.0	2.0	2.0	2.25	2.1	2.1	2.1	2.25	2.25	2.25	2.25	-	
	min.	FAB (m)	0.425	0.425	0.425	-	0.425	0.425	0.425	0.425	0.425	0.425	0.425	0.425	0.425	0.425	0.425	-	
		FAH (m)	0.7	0.7	0.7	-	0.7	0.7	0.7	0.7	0.7	0.7	0.7	0.7	0.7	0.7	0.7	-	
	min.	FAB (m)	0.68	0.68	0.68	-	0.68	0.68	0.68	0.68	0.68	0.68	0.68	0.68	0.68	0.68	0.68	-	
		FAH (m)	0.9	0.9	0.9	-	0.9	0.9	0.9	0.9	0.9	0.9	0.9	0.9	0.9	0.9	0.9	-	
	max. (kg)	100 (Klotzabst. 50 mm zur Ecke) (Shim dist. to corner 50 mm)				130				130				130					

* Windlast > 1600 Pa und FAH > 2.25 m werden zwei vertikale Zusatzverriegelungen benötigt

* Wind load > 1600 Pa and FAH 2.25 m requires two vertical additional locking points







WICLINE 75

Verdeckte Beschläge
Concealed fittings

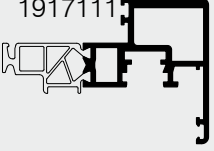
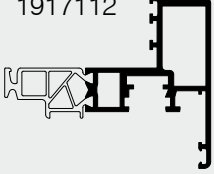
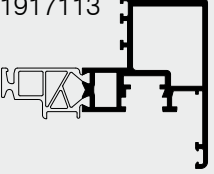

Zulässige Flügelgrößen
Admissible sash sizes



Profile Profiles		1917110 				1917111 				1917112 				1917113 				
	(Pa)	800	1200	2000	-	800	1200	2000	-	800	1200	2000	-	800	1200	2000	-	
	(Pa)	150	300	600	-	150	300	600	-	150	300	600	-	150	300	600	-	
Flügelgröße Sash size	max.	FAB (m)	1.2	1.1	1.0	-	1.3	1.2	1.1	-	1.4	1.3	1.2	-	1.4	1.4	1.3	-
		FAH (m)	1.4	1.4	1.4	-	1.6	1.6	1.6	-	1.7	1.7	1.7	-	1.8	1.8	1.8	-
	min.	FAB (m)	0.425	0.425	0.425	-	0.425	0.425	0.425	-	0.425	0.425	0.425	-	0.425	0.425	0.425	-
		FAH (m)	0.7	0.7	0.7	-	0.7	0.7	0.7	-	0.7	0.7	0.7	-	0.7	0.7	0.7	-
MV / MB	FAB (m)	-	-	-	-	-	-	-	-	-	-	-	-	-	-	-	-	
	FAH (m)	1.3	1.2	1.1	-	1.4	1.3	1.2	-	1.5	1.4	1.3	-	1.5	1.5	1.4	-	
 WK3	max.	FAB (m)	1.2	1.1	1.0	-	1.3	1.2	1.1	-	1.4	1.3	1.2	-	1.4	1.4	1.3	-
		FAH (m)	1.4	1.4	1.4	-	1.6	1.6	1.6	-	1.7	1.7	1.7	-	1.8	1.8	1.8	-
	min.	FAB (m)	0.425	0.425	0.425	-	0.425	0.425	0.425	-	0.425	0.425	0.425	-	0.425	0.425	0.425	-
		FAH (m)	0.7	0.7	0.7	-	0.7	0.7	0.7	-	0.7	0.7	0.7	-	0.7	0.7	0.7	-
 WK3	min.	FAB (m)	0.68	0.68	0.68	-	0.68	0.68	0.68	-	0.68	0.68	0.68	-	0.68	0.68	0.68	-
		FAH (m)	0.9	0.9	0.9	-	0.9	0.9	0.9	-	0.9	0.9	0.9	-	0.9	0.9	0.9	-
 max. kg	max.(kg)	80				100				100				100				







WICLINE 75

Verdeckte Beschläge
Concealed fittings

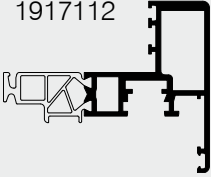
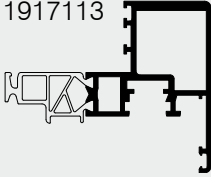

Zulässige Flügelgrößen
Admissible sash sizes



Profile Profiles		1917112 				1917113 												
	(Pa)	800	1200	2000	-	800	1200	2000	-									
	(Pa)	150	300	600	-	150	300	600	-									
Flügelgröße Sash size	max.	FAB (m)	1.4	1.3	1.2	-	1.4	1.4	1.3	-								
		FAH (m)	1.8	2.0	2.1	-	2.0	2.0	2.25	-								
	min.	FAB (m)	0.425	0.425	0.425	-	0.425	0.425	0.425	-								
		FAH (m)	0.7	0.7	0.7	-	0.7	0.7	0.7	-								
MV / MB	FAB (m)	-	-	-	-	-	-	-	-									
	FAH (m)	1.5	1.4	1.3	-	1.5	1.5	1.4	-									
 WK3	max.	FAB (m)	1.4	1.3	1.2	-	1.4	1.4	1.3	-								
		FAH (m)	1.7	1.7	1.7	-	1.8	1.8	1.8	-								
	min.	FAB (m)	0.425	0.425	0.425	-	0.425	0.425	0.425	-								
		FAH (m)	0.7	0.7	0.7	-	0.7	0.7	0.7	-								
 WK3	min.	FAB (m)	0.68	0.68	0.68	-	0.68	0.68	0.68	-								
		FAH (m)	0.9	0.9	0.9	-	0.9	0.9	0.9	-								
	max. (kg)	130***				130***												

*** Zusätzliche Verklebung, Angaben in den Verarbeitungsrichtlinien beachten!
*** Additional gluing, pay attention to specifications in the workshop manual!

WICLINE 75

Verdeckte Beschläge
Concealed fittings



Zulässige Flügelgrößen
Admissible sash sizes



Profile
Profiles

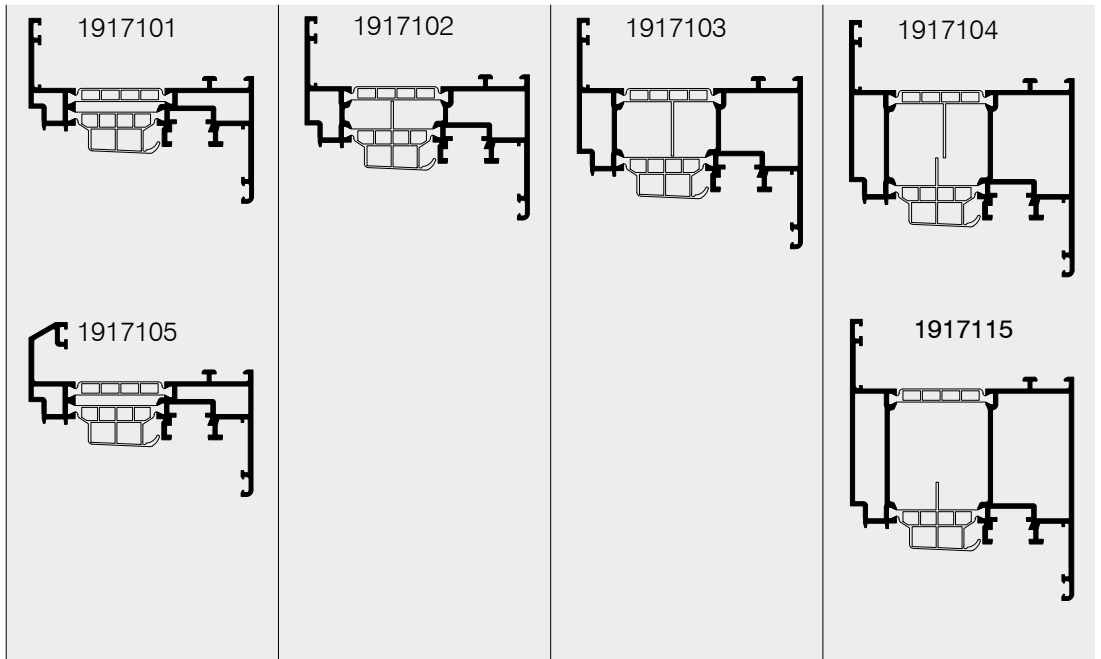

	(Pa)	800	1200	2000	-	800	1200	2000	2000	800	1200	2000	2000*	800	1200	2000*	-		
	(Pa)	150	300	600	-	150	300	600	600	150	300	600	600	150	300	600	-		
Flügelgröße Sash size	max.	FAB (m)	1.7	1.7	1.7	-	2.0	2.0	2.0	2.25	2.25	2.25	2.25	2.5	2.5	2.5	2.5	-	
		FAH (m)	1.3	1.2	1.1	-	1.6	1.5	1.4	1.0	1.6	1.6	1.5	1.0	1.7	1.7	1.6	-	
	min.	FAB (m)	0.6	0.6	0.6	-	0.6	0.6	0.6	0.6	0.6	0.6	0.6	0.6	0.6	0.6	0.6	0.6	-
		FAH (m)	0.45	0.45	0.45	-	0.45	0.45	0.45	0.45	0.45	0.45	0.45	0.45	0.45	0.45	0.45	0.45	-
MV / MB	FAB (m)	1.5	1.5	1.3	-	1.7	1.6	1.5	1.5	1.8	1.7	1.6	1.5*	1.8	1.7	1.6*	-		
	FAH (m)	-	-	-	-	-	-	1.3	-	-	-	1.3	-	-	-	1.3	-		
	max.	FAB (m)	1.7	1.7	1.7	-	2.0	2.0	2.0	-	2.1	2.1	2.1	-	2.25	2.25	2.25	-	
		FAH (m)	1.3	1.2	1.1	-	1.6	1.5	1.4	-	1.6	1.6	1.5	-	1.7	1.7	1.6	-	
	min.	FAB (m)	0.74	0.74	0.74	-	0.74	0.74	0.74	0.74	0.74	0.74	0.74	0.74	0.74	0.74	0.74	-	
		FAH (m)	0.45	0.45	0.45	-	0.45	0.45	0.45	0.45	0.45	0.45	0.45	0.45	0.45	0.45	0.45	0.45	-
	min.	FAB (m)	0.9	0.9	0.9	-	0.9	0.9	0.9	0.9	0.9	0.9	0.9	0.9	0.9	0.9	0.9	-	
		FAH (m)	0.6	0.6	0.6	-	0.6	0.6	0.6	0.6	0.6	0.6	0.6	0.6	0.6	0.6	0.6	0.6	-
	max. (kg)	100 (Klotzabst. 50 mm zur Ecke) (Shim dist. to corner 50 mm)				130				130				130					

* Windlast > 1600 Pa und FAB > 2.25 m werden zwei horizontale Zusatzverriegelungen benötigt

* Wind load > 1600 Pa and FAB 2.25 m requires two horizontal additional locking points







WICLINE 75

Verdeckte Beschläge
Concealed fittings

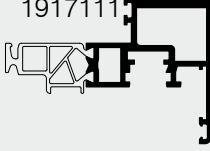
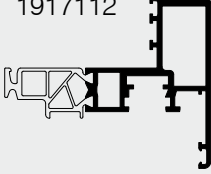
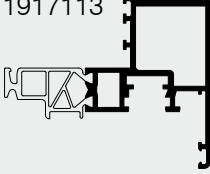

Zulässige Flügelgrößen
Admissible sash sizes



Profile Profiles		1917110 				1917111 				1917112 				1917113 				
	(Pa)	800	1200	2000	-	800	1200	2000	-	800	1200	2000	-	800	1200	2000	-	
	(Pa)	150	300	600	-	150	300	600	-	150	300	600	-	150	300	600	-	
Flügelgröße Sash size	max.	FAB (m)	1.4	1.4	1.4	-	1.6	1.6	1.6	-	1.7	1.7	1.7	-	1.8	1.8	1.8	-
		FAH (m)	1.2	1.1	1.0	-	1.3	1.2	1.1	-	1.4	1.3	1.2	-	1.4	1.4	1.3	-
	min.	FAB (m)	0.6	0.6	0.6	-	0.6	0.6	0.6	-	0.6	0.6	0.6	-	0.6	0.6	0.6	-
		FAH (m)	0.45	0.45	0.45	-	0.45	0.45	0.45	-	0.45	0.45	0.45	-	0.45	0.45	0.45	-
MV / MB	FAB (m)	1.3	1.2	1.1	-	1.4	1.3	1.2	-	1.5	1.4	1.3	-	1.5	1.5	1.4	-	
	FAH (m)	-	-	-	-	-	-	-	-	-	-	-	-	-	-	-	-	
 WK3	max.	FAB (m)	1.4	1.4	1.4	-	1.6	1.6	1.6	-	1.7	1.7	1.7	-	1.8	1.8	1.8	-
		FAH (m)	1.2	1.1	1.0	-	1.3	1.2	1.1	-	1.4	1.3	1.2	-	1.4	1.4	1.3	-
	min.	FAB (m)	0.74	0.74	0.74	-	0.74	0.74	0.74	-	0.74	0.74	0.74	-	0.74	0.74	0.74	-
		FAH (m)	0.45	0.45	0.45	-	0.45	0.45	0.45	-	0.45	0.45	0.45	-	0.45	0.45	0.45	-
 WK3	min.	FAB (m)	0.9	0.9	0.9	-	0.9	0.9	0.9	-	0.9	0.9	0.9	-	0.9	0.9	0.9	-
		FAH (m)	0.6	0.6	0.6	-	0.6	0.6	0.6	-	0.6	0.6	0.6	-	0.6	0.6	0.6	-
 max.	max.(kg)	80				100				100				100				

6







WICLINE 75

Verdeckte Beschläge
Concealed fittings

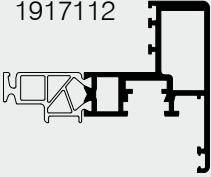
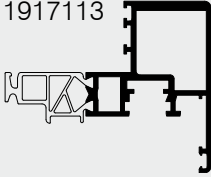

Zulässige Flügelgrößen
Admissible sash sizes



Profile Profiles		1917112 				1917113 												
	(Pa)	800	1200	2000	-	800	1200	2000	-									
	(Pa)	150	300	600	-	150	300	600	-									
Flügelgröße Sash size	max.	FAB (m)	1.8	2.0	2.1	-	2.0	2.0	2.25	-								
		FAH (m)	1.4	1.3	1.2	-	1.4	1.4	1.3	-								
	min.	FAB (m)	0.6	0.6	0.6	-	0.6	0.6	0.6	-								
		FAH (m)	0.45	0.45	0.45	-	0.45	0.45	0.45	-								
MV / MB	FAB (m)	1.5	1.4	1.3	-	1.5	1.5	1.4	-									
	FAH (m)	-	-	-	-	-	-	-	-									
 WK3	max.	FAB (m)	1.7	1.7	1.7	-	1.8	1.8	1.8	-								
		FAH (m)	1.4	1.3	1.2	-	1.4	1.4	1.3	-								
	min.	FAB (m)	0.74	0.74	0.74	-	0.74	0.74	0.74	-								
		FAH (m)	0.45	0.45	0.45	-	0.45	0.45	0.45	-								
 WK3	min.	FAB (m)	0.9	0.9	0.9	-	0.9	0.9	0.9	-								
		FAH (m)	0.6	0.6	0.6	-	0.6	0.6	0.6	-								
	max. (kg)	130***				130***												

*** Zusätzliche Verklebung, Angaben in den Verarbeitungsrichtlinien beachten!
*** Additional gluing, pay attention to specifications in the workshop manual!

WICLINE 75

Verdeckte Beschläge
Concealed fittings



Zulässige Flügelgrößen
Admissible sash sizes



Profile
Profiles

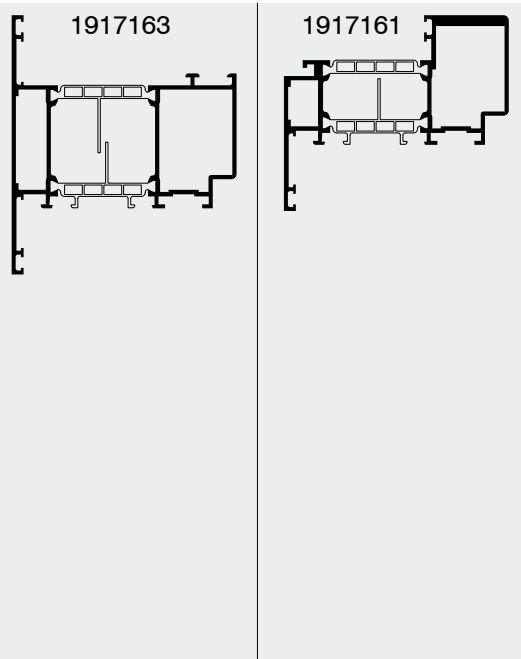

Bei Verwendung von Elektroantrieben FAH_{min.} auf Antrieb anpassen. Bei Anwendung in Fassaden ist eine Riegelüberprüfung erforderlich.
With inset of electric drive adjust FAH_{min.}. Check transom profile for application in facades.

	(Pa)	-	-	2000	2000	-	2000	2000	2000									
	(Pa)	-	-	600	600	-	600	600	600									
Flügelgröße Sash size	max.	FAB (m)	-	-	2.2	2.0	-	1.4	1.8	1.4								
		FAH (m)	-	-	2.0	2.2	-	1.4	1.4	1.8								
	min.	FAB (m)	-	-	0.6	0.6	-	0.6	0.6	0.6								
		FAH (m)	-	-	0.65	0.65	-	0.65	0.65	0.65								
MV / MB	FAB (m)	-	-	1.5*	1.5*	-	-	1.4	-									
	FAH (m)	-	-	1.5	1.5	-	-	-	1.4									
	min.	FAB (m)	-	-	-	-	-	-	-									
		FAH (m)	-	-	-	-	-	-	-	-								
	min.	FAB (m)	-	-	-	-	-	-	-									
		FAH (m)	-	-	-	-	-	-	-	-								
	max. (kg)	150 (zus. Verklebung > 120 kg) (add. gluing > 120 kg)				120		100										

* FAB > 1.8 m werden oben zwei horizontale Zusatzverriegelungen benötigt
* FAB > 1.8 m requires two horizontal additional top locking points



FAH ≤ 2.5 x FAB

WICLINE 75

Zulässige Flügelgrößen
Admissible sash sizes

Aufliegende Beschläge
Top mounted fittings



Profile
Profiles

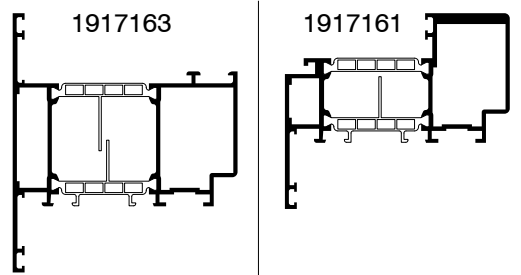

Bei Verwendung von Elektroantrieben FAH_{min.} auf Antrieb anpassen. Bei Anwendung in Fassaden ist eine Riegelüberprüfung erforderlich.

With inset of electric drive adjust FAH_{min.}. Check transom profile for application in facades.

	(Pa)	-	2000	2000	2000	-	2000	2000	2000									
	(Pa)	-	600	600	600	-	600	600	600									
Flügelgröße Sash size	max.	FAB (m)	-	1.5	2.0	2.0	-	1.4	1.8	1.4								
		FAH (m)	-	1.5	2.0	2.0	-	1.4	1.4	1.8								
	min.	FAB (m)	-	0.6	0.6	0.6	-	0.6	0.6	0.6								
		FAH (m)	-	0.425	0.425	0.425	-	0.425	0.425	0.425								
MV / MB	FAB (m)	-	-	1.5	1.5*	-	-	1.4	-									
	FAH (m)	-	-	1.5	1.5	-	-	-	1.4									
	min.	FAB (m)	-	-	-	-	-	-	-									
		FAH (m)	-	-	-	-	-	-	-	-								
	min.	FAB (m)	-	-	-	-	-	-	-									
		FAH (m)	-	-	-	-	-	-	-	-								
	max. (kg)		80	100	150***		80	100										

* FAB > 1.8 m werden zwei horizontale Mittelbänder (MB) benötigt
* FAB > 1.8 m requires two horizontal centre hinges (MB)

*** Zusätzliche Verklebung > 120 kg
*** Additional gluing > 120 kg



FAH ≤ 2.5 x FAB

WICLINE 75

Zulässige Flügelgrößen
Admissible sash sizes

Aufliegende Beschläge
Top mounted fittings



Profile
Profiles

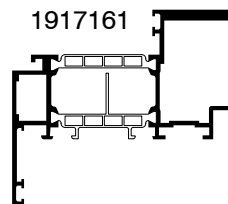
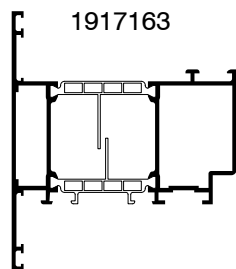





	(Pa)	-	2000	2000	2000	-	2000	2000	2000	-	2000	2000	2000	-	2000	2000	2000	
	(Pa)	-	600	600	600	-	600	600	600	-	600	600	600	-	600	600	600	
Flügelgröße Sash size	max.	FAB (m)	-	2.4	2.3	2.1	-	1.9	1.7	2.0	-	2.3	2.2	2.1	-	2.0	1.9	1.8
		FAH (m)	-	1.4	1.5	1.6	-	1.8	2.0	1.7	-	1.0	1.1	1.2	-	1.4	1.6	1.8
	min.	FAB (m)	-	0.7	0.7	0.7	-	0.7	0.7	0.7	-	0.7	0.7	0.7	-	0.7	0.7	0.7
		FAH (m)	-	0.7	0.7	0.7	-	0.7	0.7	0.7	-	0.7	0.7	0.7	-	0.7	0.7	0.7
MV / MB	FAB (m)	-	1.5	1.5	1.5	-	1.5	1.5	1.5	-	1.4	1.4	1.4	-	1.4	1.4	1.4	
	FAH (m)	-	-	-	-	-	-	-	-	-	-	-	-	-	-	-	-	
	min.	FAB (m)	-	-	-	-	-	-	-	-	-	-	-	-	-	-	-	
		FAH (m)	-	-	-	-	-	-	-	-	-	-	-	-	-	-	-	
	min.	FAB (m)	-	-	-	-	-	-	-	-	-	-	-	-	-	-	-	
		FAH (m)	-	-	-	-	-	-	-	-	-	-	-	-	-	-	-	
	max. (kg)		100				100				80				100			



Diagramm zulässige Formatgrößen beachten
Diagram admissible format sizes

WICLINE 75

Zulässige Flügelgrößen
Admissible sash sizes

Verdeckte Beschläge
Concealed fittings



Profile
Profiles

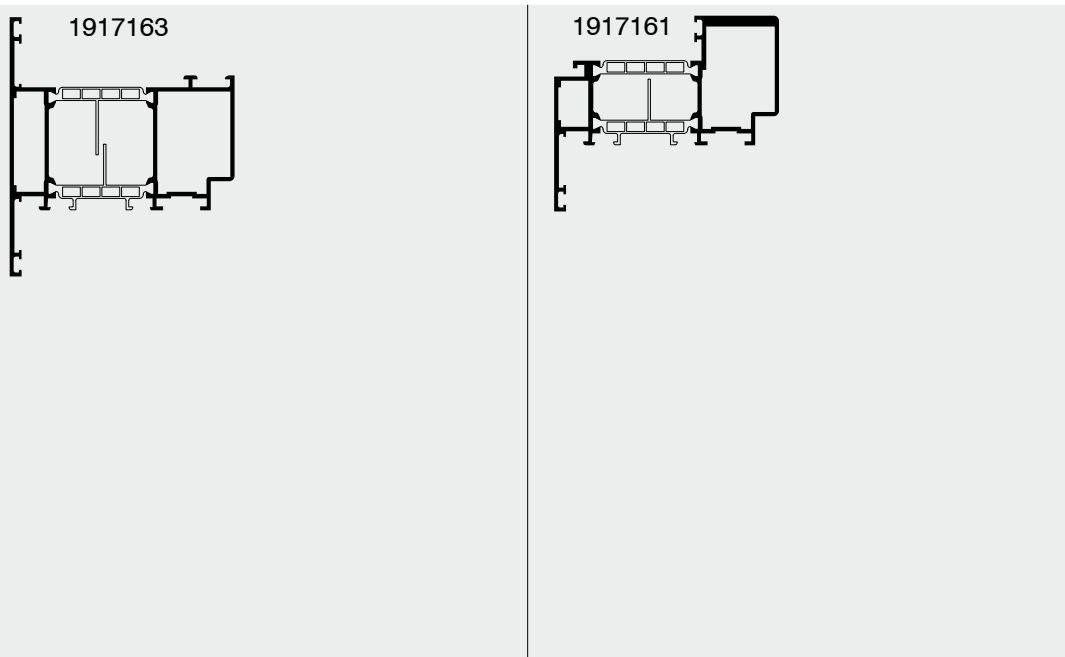

	(Pa)	-	2000	2000	2000	-	-	2000	2000	-	2000	2000	2000	-	2000	2000	2000	
	(Pa)	-	600	600	600	-	-	600	600	-	600	600	600	-	600	600	600	
Flügelgröße Sash size	max.	FAB (m)	-	2.5	2.4	2.3	-	-	2.0	2.0	-	2.3	2.2	2.1	-	2.0	1.9	1.8
		FAH (m)	-	1.4	1.6	1.8	-	-	2.2	2.2	-	1.0	1.1	1.2	-	1.4	1.6	1.8
	min.	FAB (m)	-	0.7	0.7	0.7	-	-	0.7	0.7	-	0.7	0.7	0.7	-	0.7	0.7	0.7
		FAH (m)	-	0.7	0.7	0.7	-	-	0.7	0.7	-	0.7	0.7	0.7	-	0.7	0.7	0.7
MV / MB	FAB (m)	-	1.5	1.5	1.5	-	-	1.5	1.5	-	1.4	1.4	1.4	-	1.4	1.4	1.4	
	FAH (m)	-	-	-	-	-	-	-	-	-	-	-	-	-	-	-	-	
	min.	FAB (m)	-	-	-	-	-	-	-	-	-	-	-	-	-	-	-	
		FAH (m)	-	-	-	-	-	-	-	-	-	-	-	-	-	-	-	
	min.	FAB (m)	-	-	-	-	-	-	-	-	-	-	-	-	-	-	-	
		FAH (m)	-	-	-	-	-	-	-	-	-	-	-	-	-	-	-	
	max.(kg)		120			150			80			100						



Diagramm zulässige Formatgrößen beachten
Diagram admissible format sizes

WICLINE 75

Zulässige Flügelgrößen
Admissible sash sizes

Aufliegende Beschläge
Top mounted fittings



Profile Profiles		1917163				1917161												
	(Pa)	800	800	-	-	800	800	-	-									
	(Pa)	150	150	-	-	150	150	-	-									
Flügelgröße Sash size	max.	FAB (m)	1.8	1.7	-	-	1.8	1.6	-	-								
		FAH (m)	1.8	2.0	-	-	1.8	1.9	-	-								
	min.	FAB (m)	0.7	0.7	-	-	0.7	0.7	-	-								
		FAH (m)	0.7	0.7	-	-	0.7	0.7	-	-								
MV / MB	FAB (m)	-	-	-	-	-	-	-	-									
	FAH (m)	1.5	1.5	-	-	1.4	1.4	-	-									
	min.	FAB (m)	-	-	-	-	-	-	-									
		FAH (m)	-	-	-	-	-	-	-	-								
	min.	FAB (m)	-	-	-	-	-	-	-									
		FAH (m)	-	-	-	-	-	-	-	-								
	max. (kg)	100				100												



Diagramm zulässige Formatgrößen beachten
Diagram admissible format sizes

WICLINE 75

Zulässige Flügelgrößen
Admissible sash sizes

Verdeckte Beschläge
Concealed fittings



Profile
Profiles

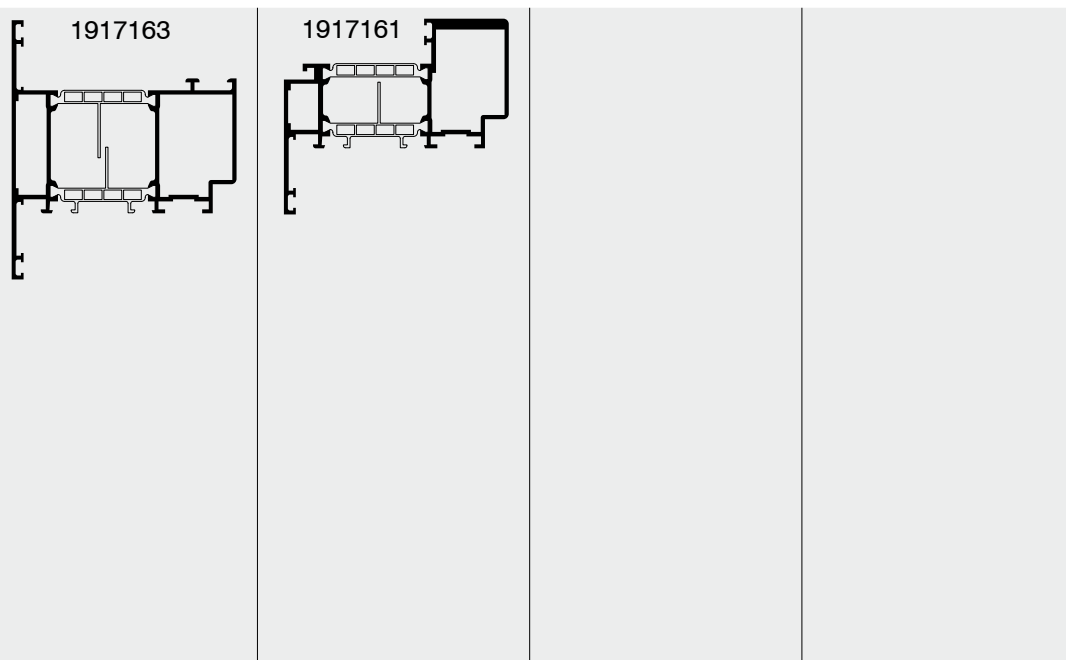

	(Pa)	800	800	-	-	800	800	-	-								
	(Pa)	150	150	-	-	150	150	-	-								
Flügelgröße Sash size	max.	FAB (m)	2.0	1.8	-	-	1.8	1.6	-	-							
		FAH (m)	2.0	2.2	-	-	1.8	1.9	-	-							
	min.	FAB (m)	0.7	0.7	-	-	0.7	0.7	-	-							
		FAH (m)	0.7	0.7	-	-	0.7	0.7	-	-							
MV / MB	FAB (m)	-	-	-	-	-	-	-	-								
	FAH (m)	1.5	1.5	-	-	1.4	1.4	-	-								
	min.	FAB (m)	-	-	-	-	-	-	-								
		FAH (m)	-	-	-	-	-	-	-	-							
	min.	FAB (m)	-	-	-	-	-	-	-								
		FAH (m)	-	-	-	-	-	-	-	-							
	max.(kg)			120				100									



Diagramm zulässige Formatgrößen beachten
Diagram admissible format sizes

WICLINE 75

Zulässige Flügelgrößen
Admissible sash sizes

Aufliegende Beschläge, Fenstertür einwärts
Top mounted fittings, french window inwards



Profile Profiles		1917104				1917115												
	(Pa)	800	1200	1600	2000*													
	(Pa)	150	300	600	600													
Flügelgröße Sash size	max.	FAB (m)	1.7	1.7	1.6	1.6												
		FAH (m)	2.5	2.5	2.5	2.5												
	min.	FAB (m)	0.45	0.45	0.45	0.45												
		FAH (m)	0.95	0.95	0.95	0.95												
MV / MB	FAB (m)	-	-	-	1.3													
	FAH (m)	1.8	1.7	1.6	1.6*													
	min.	FAB (m)	-	-	-	-												
		FAH (m)	-	-	-	-												
	min.	FAB (m)	-	-	-	-												
		FAH (m)	-	-	-	-												
	max. (kg)	160 (siehe Beschläge "zulässige Formatgrößen") (see fittings "Admissible format sizes")																







* Windlast > 1600 Pa und FAH > 2.25 m werden zwei vertikale Zusatzverriegelung benötigt
* Wind load > 1600 Pa and FAH > 2.25 m requires two verticale additional locking points

WICLINE 75

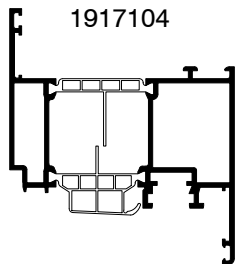
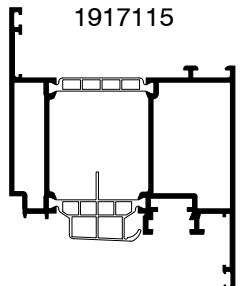
Zulässige Flügelgrößen
Admissible sash sizes

Aufliegende Beschläge, Fenstertür einwärts, barrierefrei
Top mounted fittings, french window inwards, accessible



Profile Profiles		 1917104				 1917115												
	(Pa)	800	1200	1600	2000*													
	(Pa)	150	300	600	600													
Flügelgröße Sash size	max.	FAB (m)	1.4	1.4	1.3	1.3												
		FAH (m)	2.5	2.5	2.5	2.5												
	min.	FAB (m)	0.45	0.45	0.45	0.45												
		FAH (m)	0.95	0.95	0.95	0.95												
MV / MB	FAB (m)	-	-	-	-													
	FAH (m)	1.8	1.7	1.6	1.5*													
	min.	FAB (m)	-	-	-	-												
		FAH (m)	-	-	-	-												
	min.	FAB (m)	-	-	-	-												
		FAH (m)	-	-	-	-												
	max. (kg)	130																

* Windlast > 1600 Pa und FAH > 2.25 m werden zwei vertikale Zusatzverriegelung benötigt
* Wind load > 1600 Pa and FAH > 2.25 m requires two vertical additional locking points

WICLINE 75

Zulässige Flügelgrößen
Admissible sash sizes

Aufliegende Beschläge, Fenstertür einwärts
Top mounted fittings, french window inwards

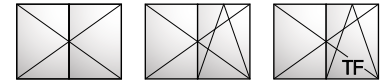

Profile Profiles		1917104																
1917121		1917115																
Stulpaufsatzprofil mit Stulpgetriebe Double casement supplement profile with double casement gear																		
	(Pa)	800	1200	1600* (2.0)**	-													
	(Pa)	150	300	600	-													
Flügelgröße Sash size	max.	FAB (m)	1.7	1.7	1.6	-												
		FAH (m)	2.5	2.5	2.5	-												
	min.	FAB (m)	0.45	0.45	0.45	-												
		FAH (m)	0.95	0.95	0.95	-												
MV / MB	FAB (m)	1.3	1.3	1.3	-													
	FAH (m)	1.8	1.7	1.6*	-													
	min.	FAB (m)	-	-	-	-												
		FAH (m)	-	-	-	-												
	min.	FAB (m)	-	-	-	-												
		FAH (m)	-	-	-	-												
	max. (kg)	160 (siehe Beschläge "zulässige Formatgrößen") (see fittings "Admissible format sizes")																

* Windlast > 1200 Pa und FAH > 2.25 m werden zwei vertikale Zusatzverriegelung benötigt
* Wind load > 1200 Pa and FAH > 2.25 m requires two vertical additional locking points

** Flügelgröße > () m² benötigt eine horizontale Zusatzverriegelung am Gehflügel und Standflügel
** Sash size > () m² requires a horizontal additional locking points in active leaf and inactive leaf

WICLINE 75

Zulässige Flügelgrößen
Admissible sash sizes

Aufliegende Beschläge, Fenstertür einwärts, barrierefrei
Top mounted fittings, french window inwards, accessible



Profile Profiles		1917104																
1917121		1917115																
Stulpaufsatzprofil mit Stulpgetriebe Double casement supplement profile with double casement gear																		
	(Pa)	400	800	1200* (2.0)**	-													
	(Pa)	150	200	300	-													
Flügelgröße Sash size	max.	FAB (m)	1.2	1.1	1.0	-												
		FAH (m)	2.5	2.5	2.5	-												
	min.	FAB (m)	0.45	0.45	0.45	-												
		FAH (m)	0.95	0.95	0.95	-												
MV / MB	FAB (m)	-	-	-	-													
	FAH (m)	1.8	1.7	1.6*	-													
	min.	FAB (m)	-	-	-	-												
		FAH (m)	-	-	-	-												
	min.	FAB (m)	-	-	-	-												
		FAH (m)	-	-	-	-												
	max. (kg)	130																

* Windlast > 800 Pa und FAH > 2.25 m werden zwei vertikal Zusatzverriegelung benötigt
* Wind load > 800 Pa and FAH > 2.25 m requires two vertical additional locking points

** Flügelgröße > () m² benötigt eine horizontale Zusatzverriegelung am Gehflügel oben
** Sash size > () m² requires a horizontal additional locking points in active leaf on top

WICLINE 75

Zulässige Flügelgrößen
Admissible sash sizes

Aufliegende Beschläge, Fenstertür auswärts
Top mounted fittings, french window outwards



Profile Profiles		<p>1917163</p>															
(Pa)		2000	2000	2000	2000												
(Pa)		600	600	600	600												
Flügelgröße Sash size	max.	FAB (m)	1.2	1.5	1.4	1.2											
		FAH (m)	2.25	2.1	2.25	2.5											
	min.	FAB (m)	0.45	0.45	0.45	0.45											
		FAH (m)	0.75	0.75	0.75	0.75											
MV / MB	FAB (m)	-	1.3	1.3	-												
	FAH (m)	1.4	1.4	1.4	1.4												
min.	FAB (m)	-	-	-	-												
	FAH (m)	-	-	-	-												
min.	FAB (m)	-	-	-	-												
	FAH (m)	-	-	-	-												
max.	max.(kg)	80	100														

6



Diagramm zulässige Formatgrößen beachten
Diagram admissible format sizes

WICLINE 75

Zulässige Flügelgrößen
Admissible sash sizes

Aufliegende Beschläge, Fenstertür auswärts, barrierefrei
Top mounted fittings, french window outwards, accessible



Profile
Profiles

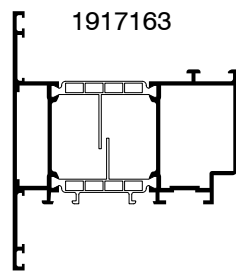

	(Pa)	800	1200	2000	-													
	(Pa)	150	300	600	-													
Flügelgröße Sash size	max.	FAB (m)	1.3	1.2	1.1	-												
		FAH (m)	2.25	2.25	2.25	-												
	min.	FAB (m)	0.45	0.45	0.45	-												
		FAH (m)	0.75	0.75	0.75	-												
MV / MB	FAB (m)	-	-	-	-													
	FAH (m)	1.4	1.4	1.4	-													
	min.	FAB (m)	-	-	-	-												
		FAH (m)	-	-	-	-												
	min.	FAB (m)	-	-	-	-												
		FAH (m)	-	-	-	-												
	max.(kg)	80 / 100																



Diagramm zulässige Formatgrößen beachten
Diagram admissible format sizes



Bei Einsatz von 4x Bänder Flügelgewicht
max. 100 kg möglich
With inset of 4x hinges sash weight
max. 100 kg possible

WICLINE 75

Zulässige Flügelgrößen
Admissible sash sizes

Aufliegende Beschläge, Fenstertür auswärts
Top mounted fittings, french window outwards

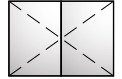

Profile
Profiles

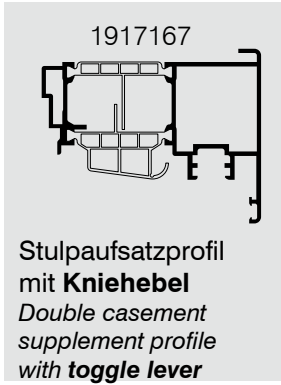
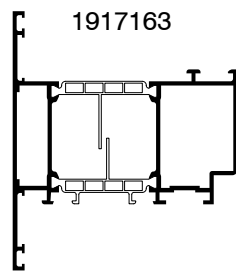

	(Pa)	1600	1600	1600	-														
	(Pa)	600	600	600	-														
Flügelgröße Sash size	max.	FAB (m)	1.3	1.2	1.0	-													
		FAH (m)	2.1	2.25	2.5	-													
	min.	FAB (m)	0.45	0.45	0.45	-													
		FAH (m)	0.75	0.75	0.75	-													
MV / MB	FAB (m)	-	-	-	-														
	FAH (m)	1.4	1.4	1.4	-														
	min.	FAB (m)	-	-	-	-													
		FAH (m)	-	-	-	-													
	min.	FAB (m)	-	-	-	-													
		FAH (m)	-	-	-	-													
	max.(kg)	80 / 100																	



Bei Einsatz von 4x Bänder Flügelgewicht
max. 100 kg möglich
With inset of 4x hinges sash weight
max. 100 kg possible

WICLINE 75

Zulässige Flügelgrößen
Admissible sash sizes

Aufliegende Beschläge, Fenstertür auswärts, barrierefrei
Top mounted fittings, french window outwards, accessible



Profile
Profiles

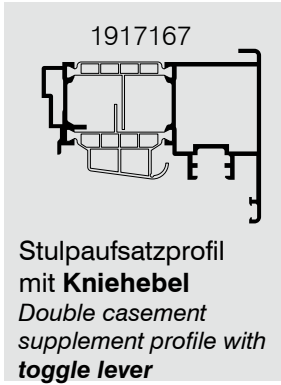
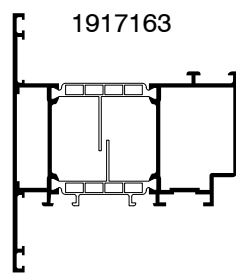

	(Pa)	400	800	1200	-													
	(Pa)	150	200	300	-													
Flügelgröße Sash size	max.	FAB (m)	1.2	1.1	1.0	-												
		FAH (m)	2.25	2.25	2.25	-												
	min.	FAB (m)	0.45	0.45	0.45	-												
		FAH (m)	0.75	0.75	0.75	-												
MV / MB	FAB (m)	-	-	-	-													
	FAH (m)	1.4	1.4	1.4	-													
	min.	FAB (m)	-	-	-	-												
		FAH (m)	-	-	-	-												
	min.	FAB (m)	-	-	-	-												
		FAH (m)	-	-	-	-												
	max. (kg)	80 / 100																



Diagramm zulässige Formatgrößen beachten
Diagram admissible format sizes



Bei Einsatz von 4x Bänder Flügelgewicht
max. 100 kg möglich
With inset of 4x hinges sash weight
max. 100 kg possible

»» Sonnenschutz

Sun shade



Der aktive Sonnen- und Blendschutz leistet einen wichtigen Beitrag zur Energieeinsparung in modernen Gebäudehüllen und trägt zum Wohlbefinden der Nutzer bei.

Sonnenschutz dient u.a. dem:

- Schutz vor Überhitzung
- Reduzierung der Kühlenergie
- Steuern der Tageslichtnutzung

Die verschiedenen Sonnenschutzlösungen lassen sich dabei flexibel, individuell und mit System in die Gebäudehülle integrieren und wirken als Gestaltungselemente in der Fassade.

Die Planung von Sonnenschutz erfolgt immer objektspezifisch. Nur so lassen sich die komplexen Anforderungen, die ein modernes Gebäude an ein Sonnenschutzkonzept stellt, erfüllen.

Active sun protection and light direction are integral parts of a modern building skin and have a strong influence both on the reduction of energy consumption and user comfort.

Sun shading systems

- *protect the building from excessive heat*
- *reduce the consumption of cooling energy*
- *reduce the need for artificial lighting*

The various solutions for solar shading can be blended in the building skin in a versatile and individual way as a system solution and become an integral technical and optical part of the façade.

The design and planning of solar shading is always specific for an individual project. Only bespoke solutions can guarantee the fulfilment of the complex requirements for sun protection and light direction imposed by modern architecture.

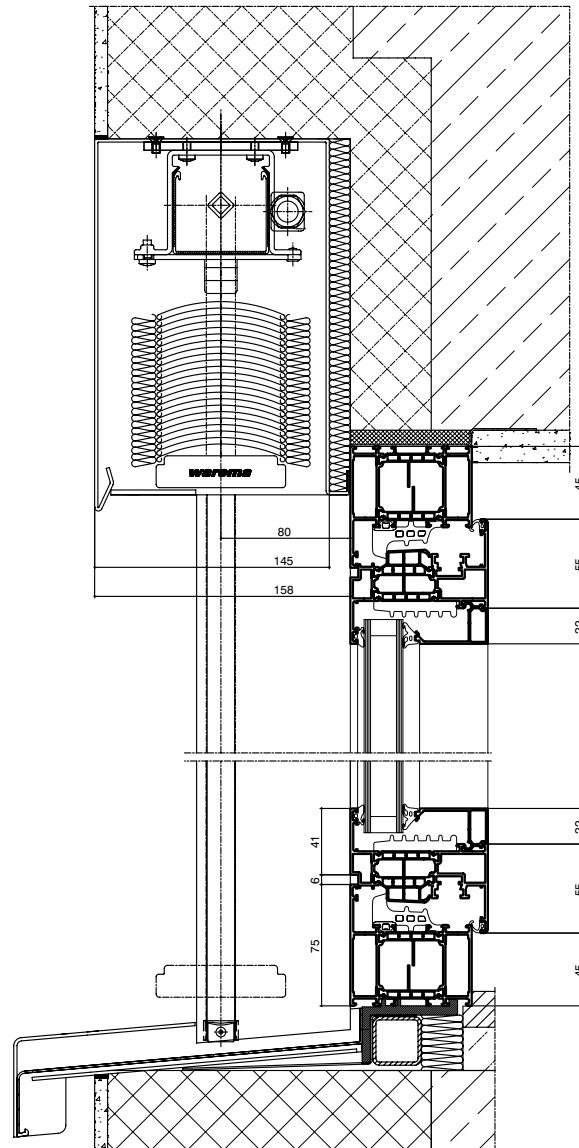
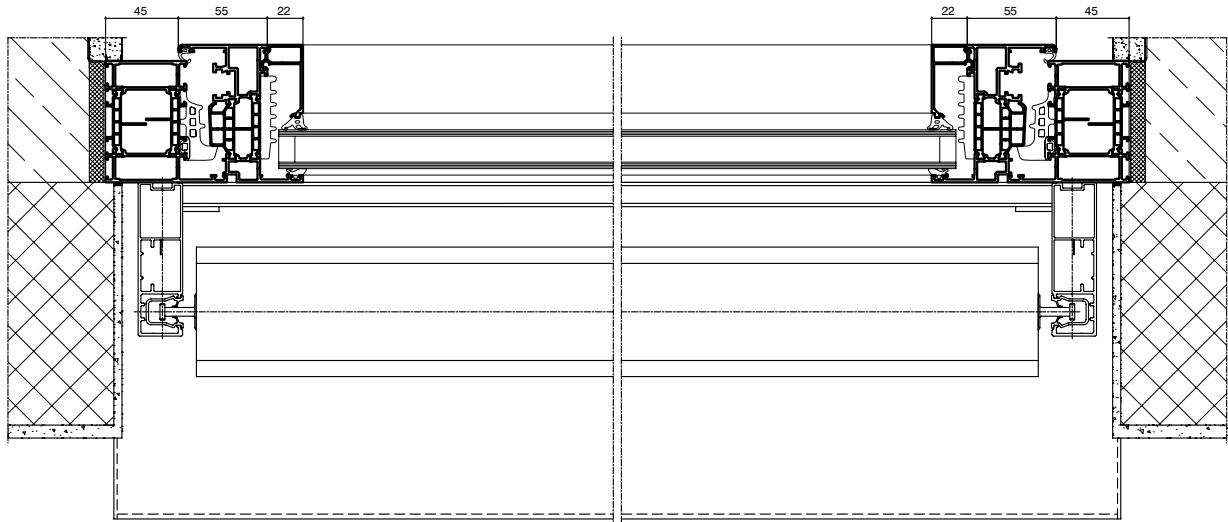

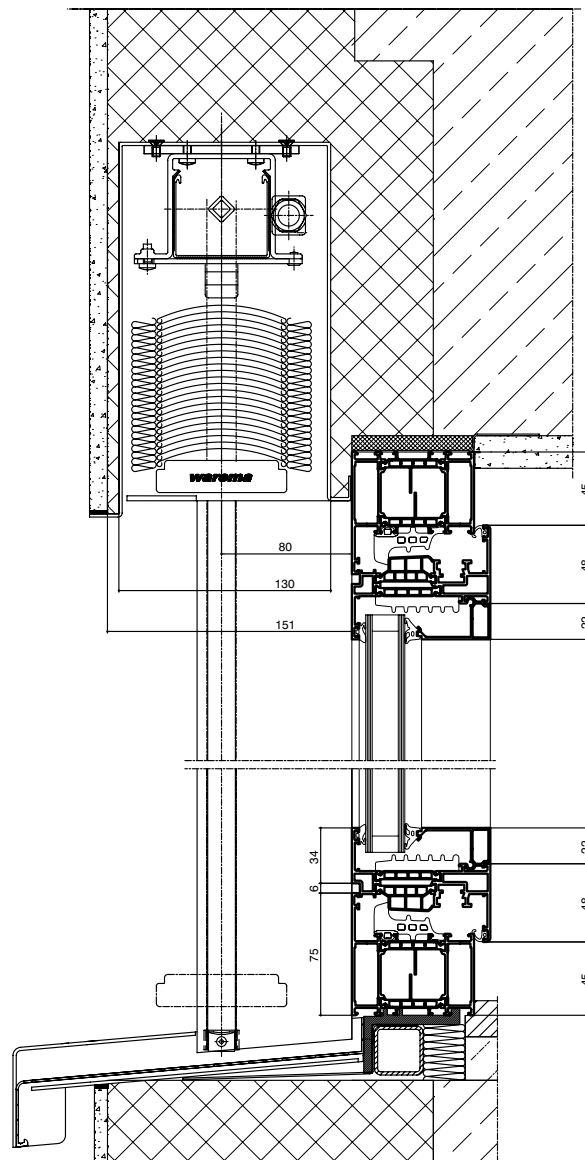
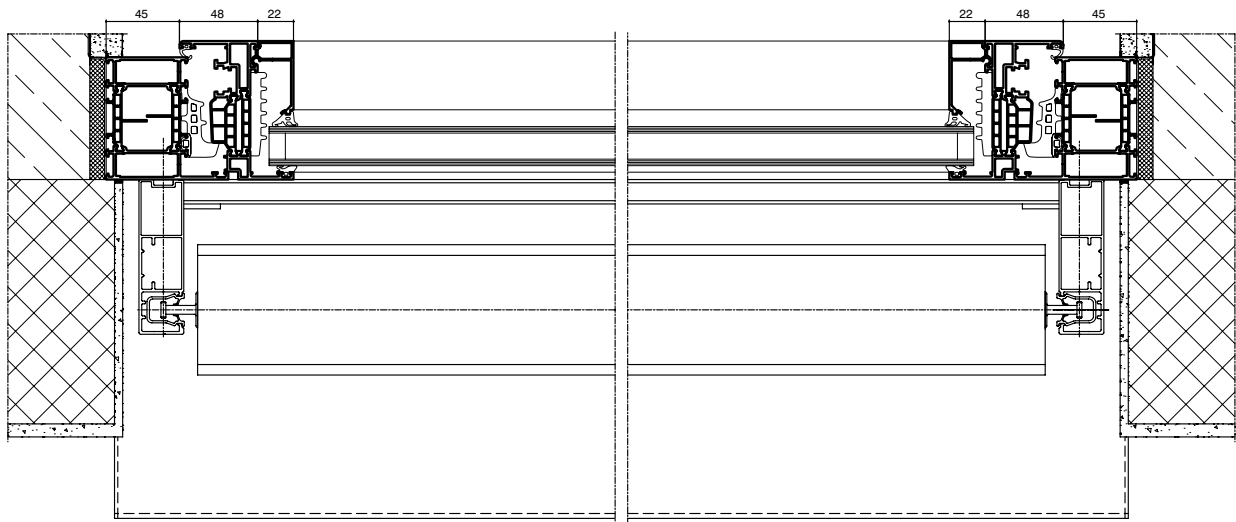

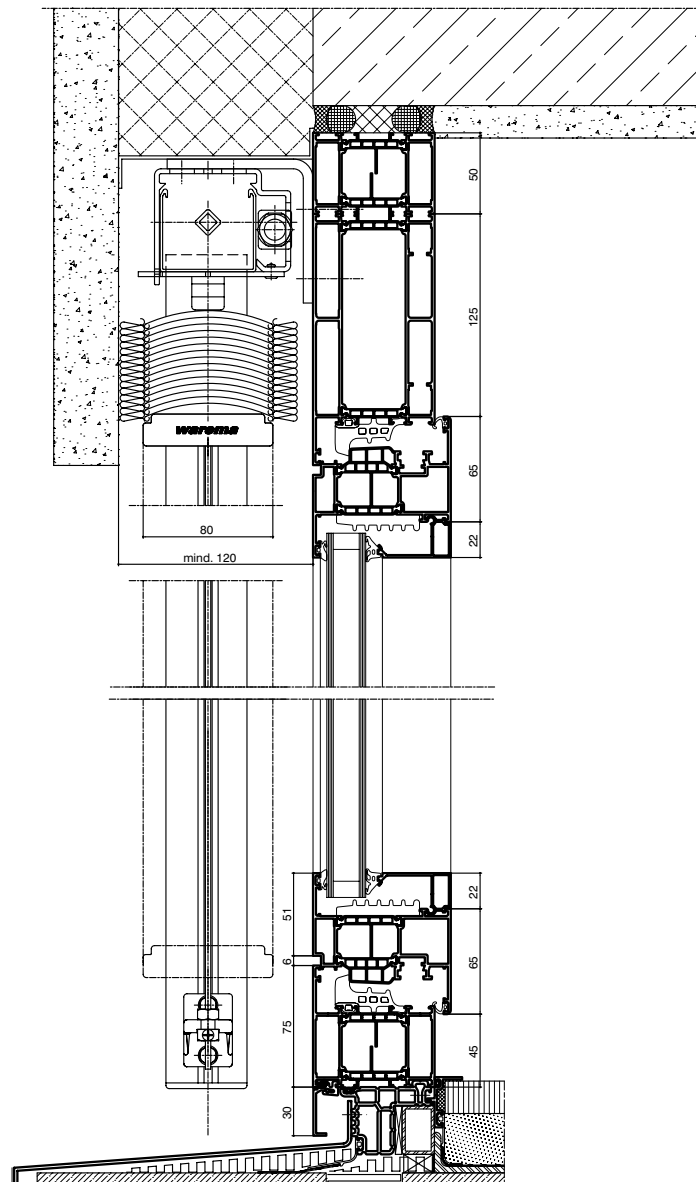
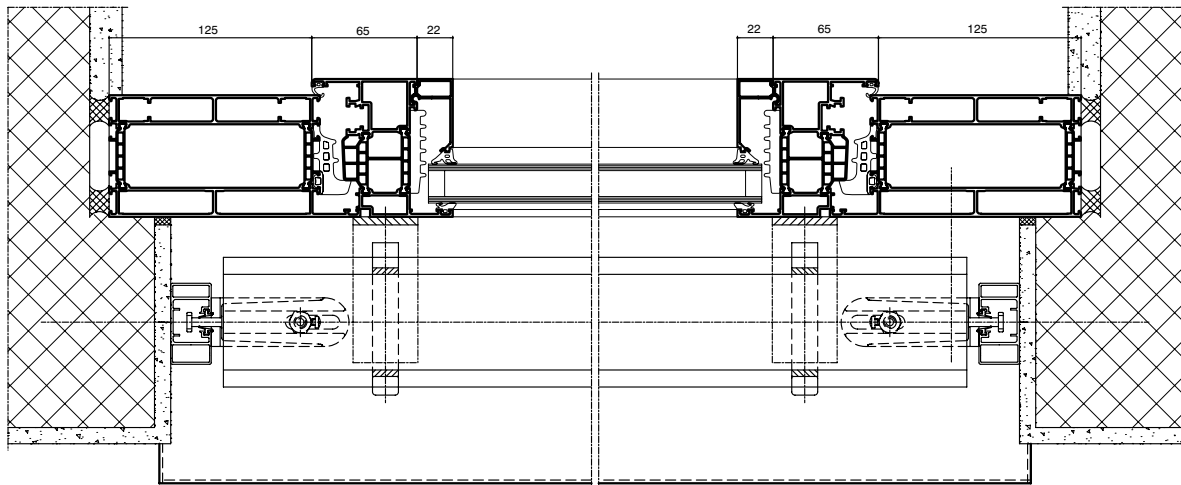

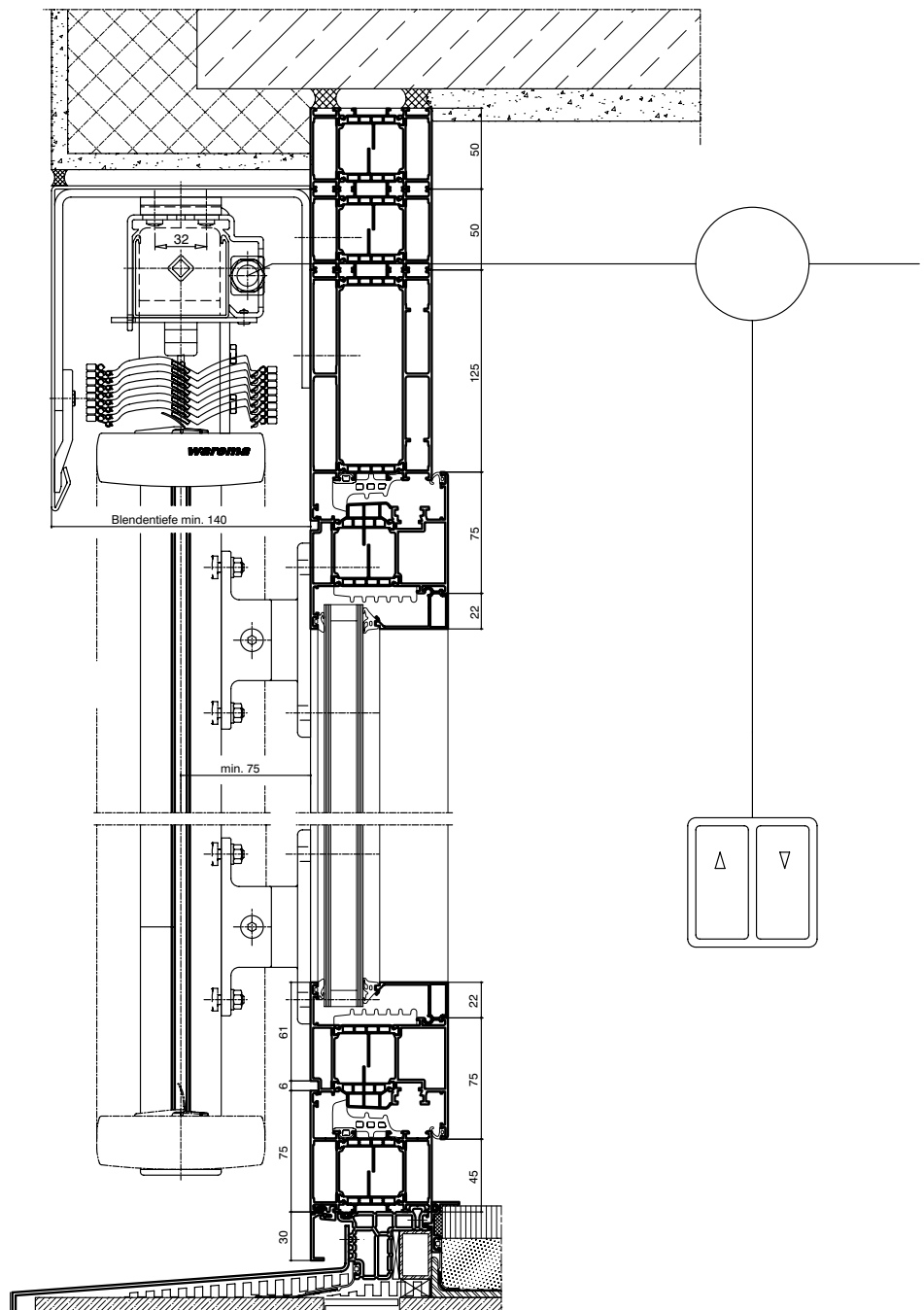
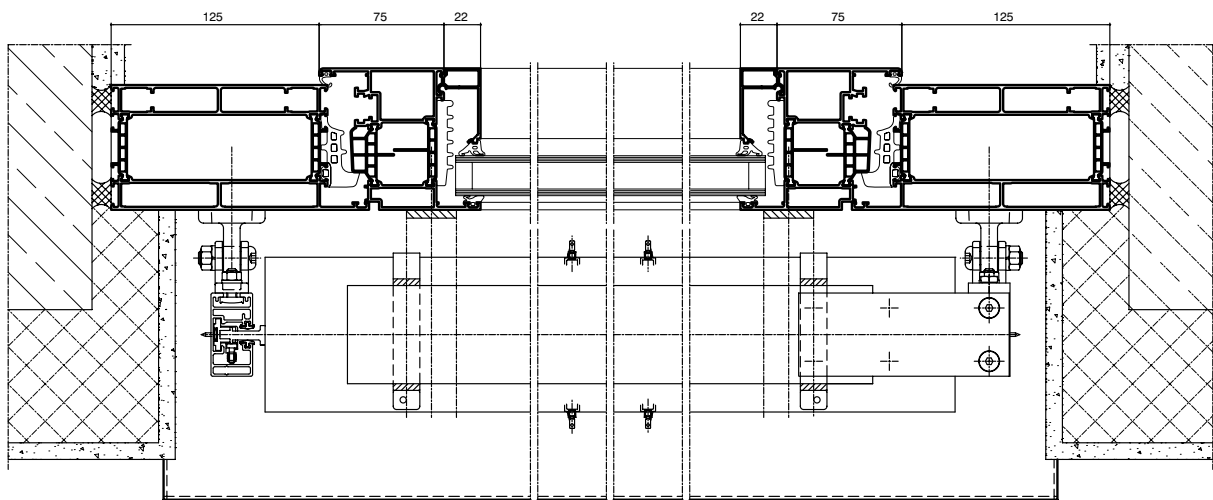

» Konstruktionsschnitte

Construction sections



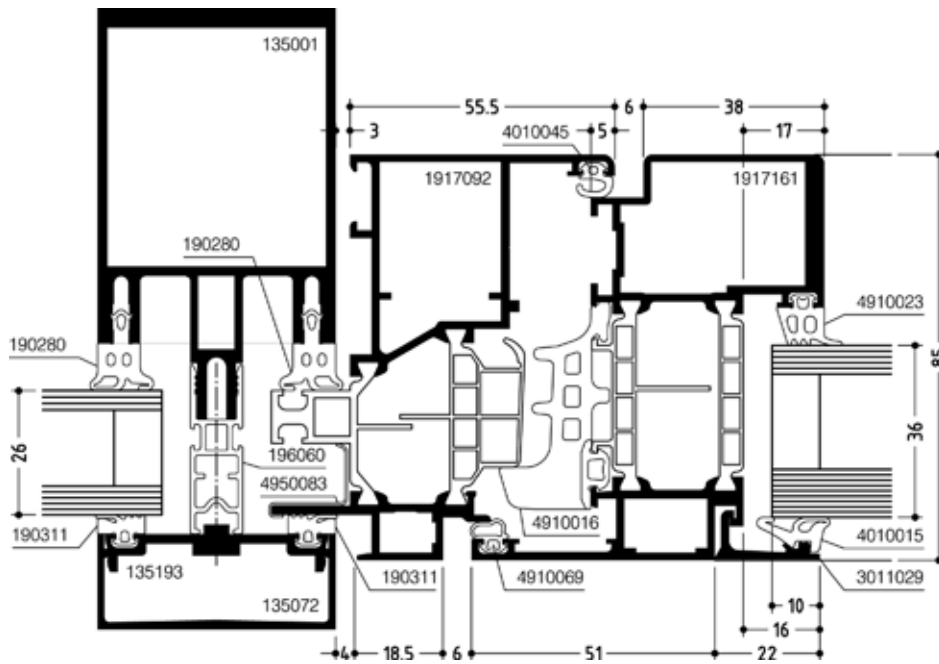

DOC-0000763325

Senk-Klappfenster
Italian style window

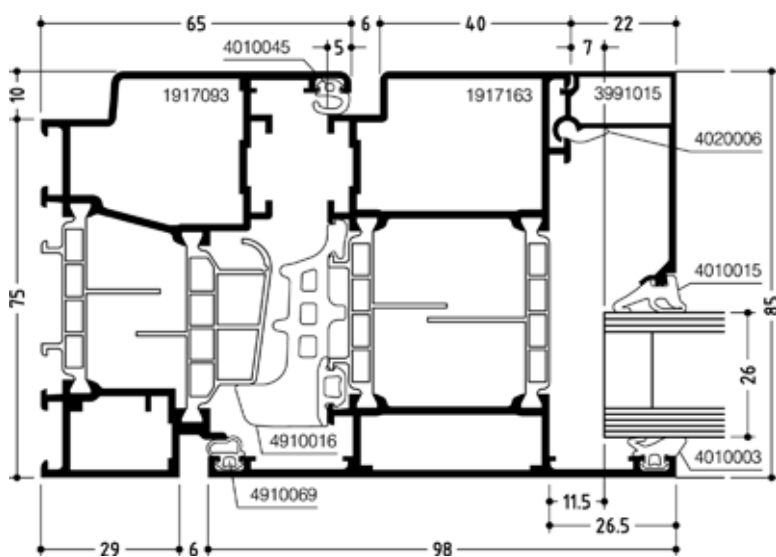

DOC-0000772062

Klappfenster
Top-hung window

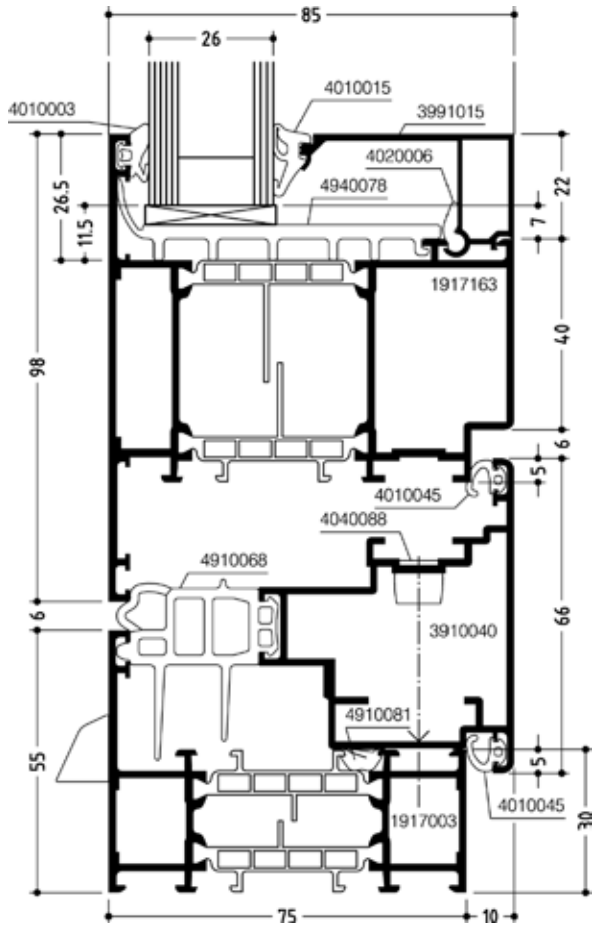

DOC-0000775087

Schwing-Wende-
Fenster
*Horizontal/vertical
pivot window*

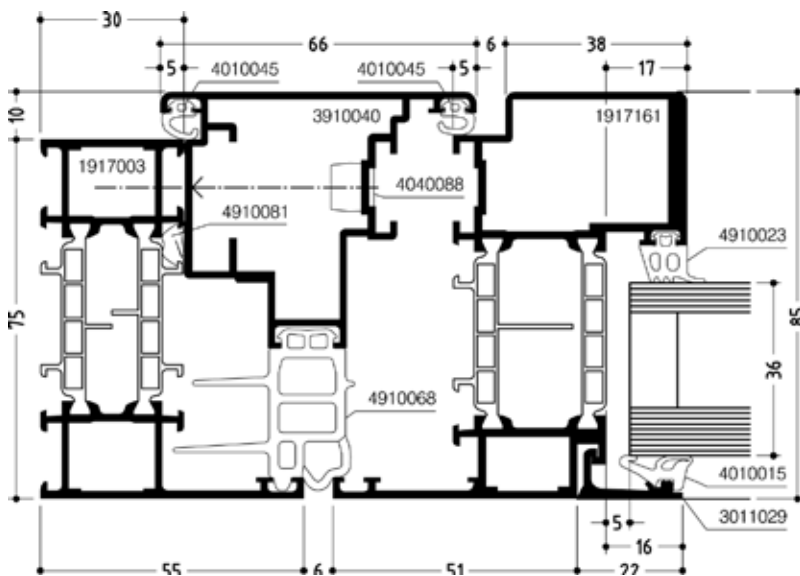

DOC-0000774972

Schwing-Wende-
Fenster
*Horizontal/vertical
pivot window*

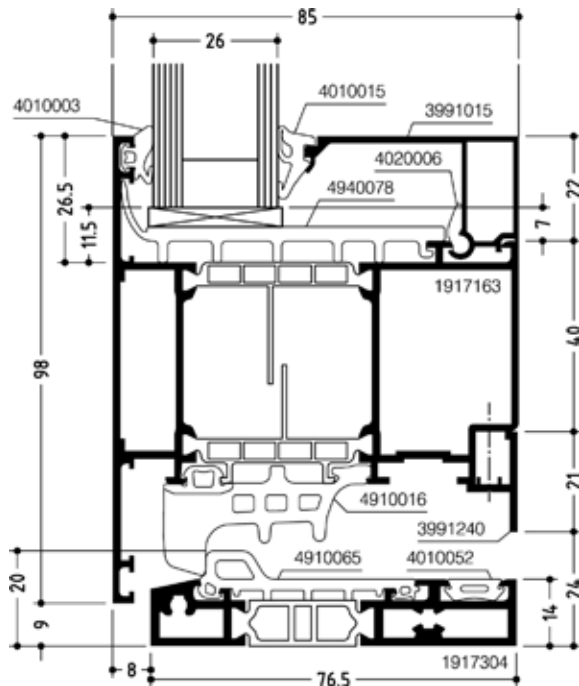

DOC-0000746259

Fenstertür mit
Schwellenprofil,
auswärts

*Casement door
with threshold
profile, outwards*

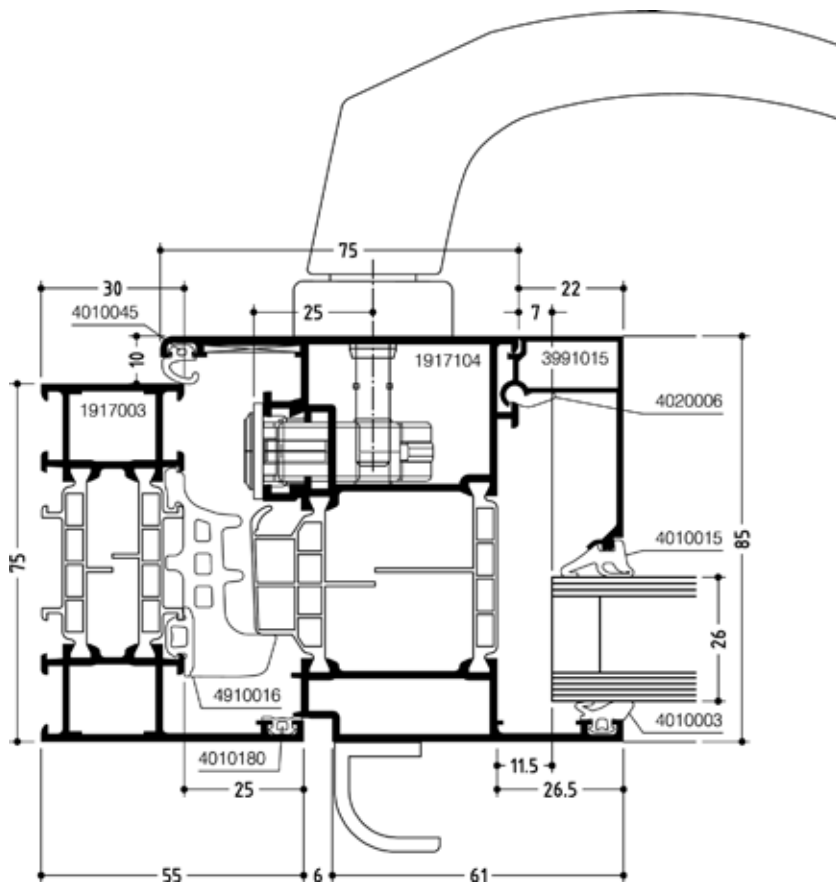

DOC-0000771923

Fenstertür, einwärts
*Casement door,
inwards*

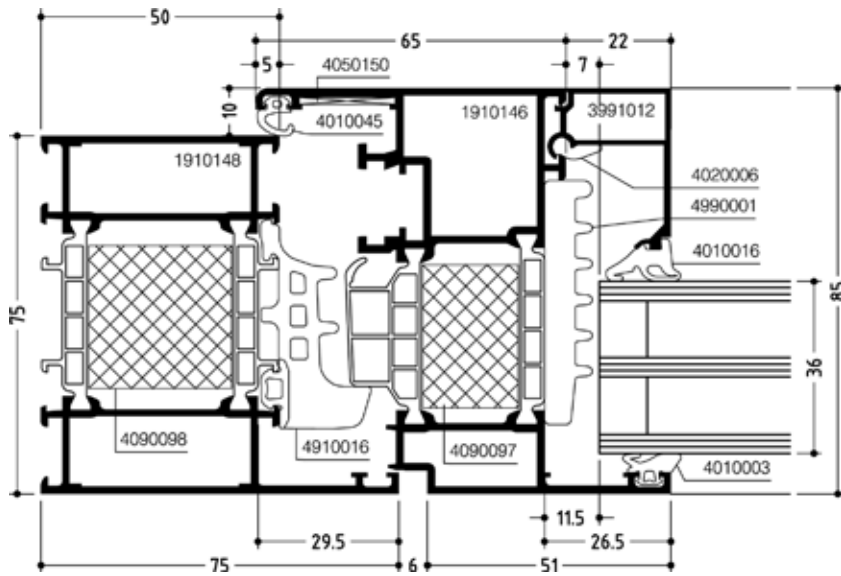

DOC-0000781819

Hochwärme-
dämmend
Flügelprofil im
Blendrahmen mit
Spezial-Dämmprofil
*High insulated Sash
profile in frame with
special insulation
profile*

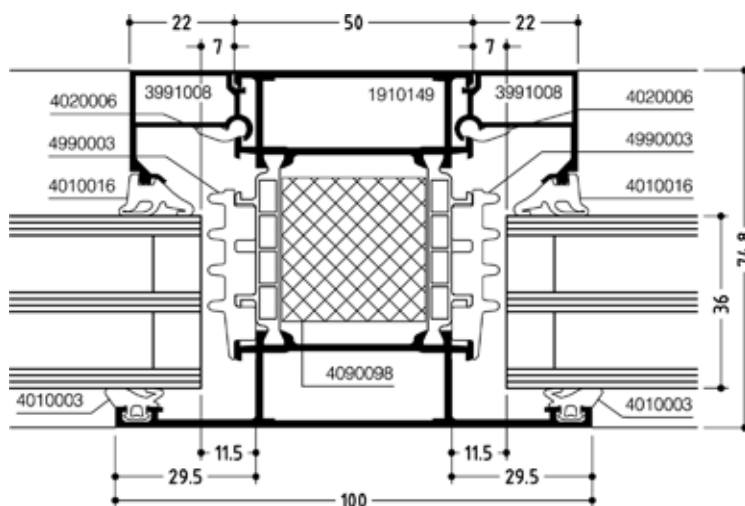

DOC-0000785855

Hochwärme-
dämmend
Kämpferprofil mit
Festverglasung
und Spezial-
Dämmprofil
*High insulated
Transom profile
with fixed glazing
and special
insulation profile*

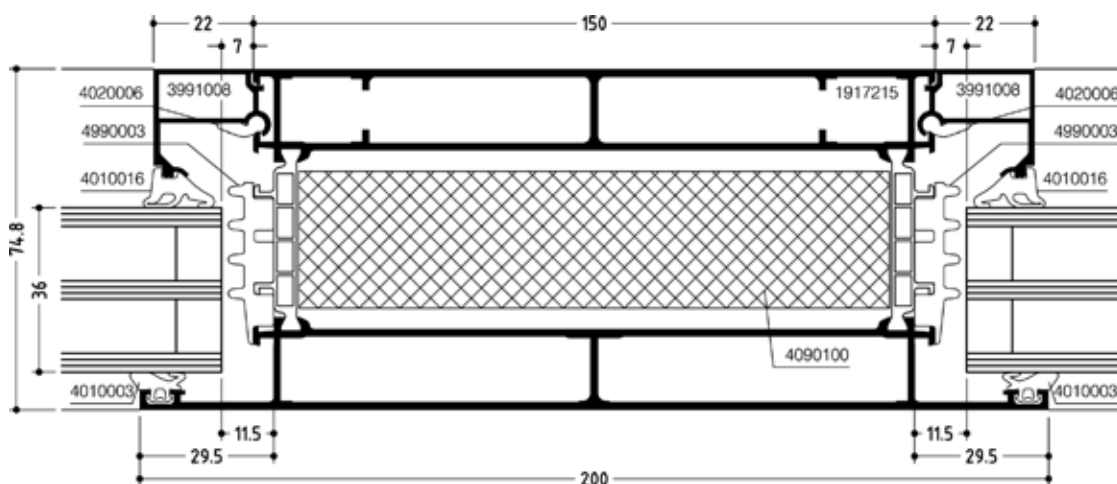

DOC-0000785934

Hochwärme-
dämmend
Kämpferprofil mit
Festverglasung
und Spezial-
Dämmprofil
*High insulated
Transom profile*

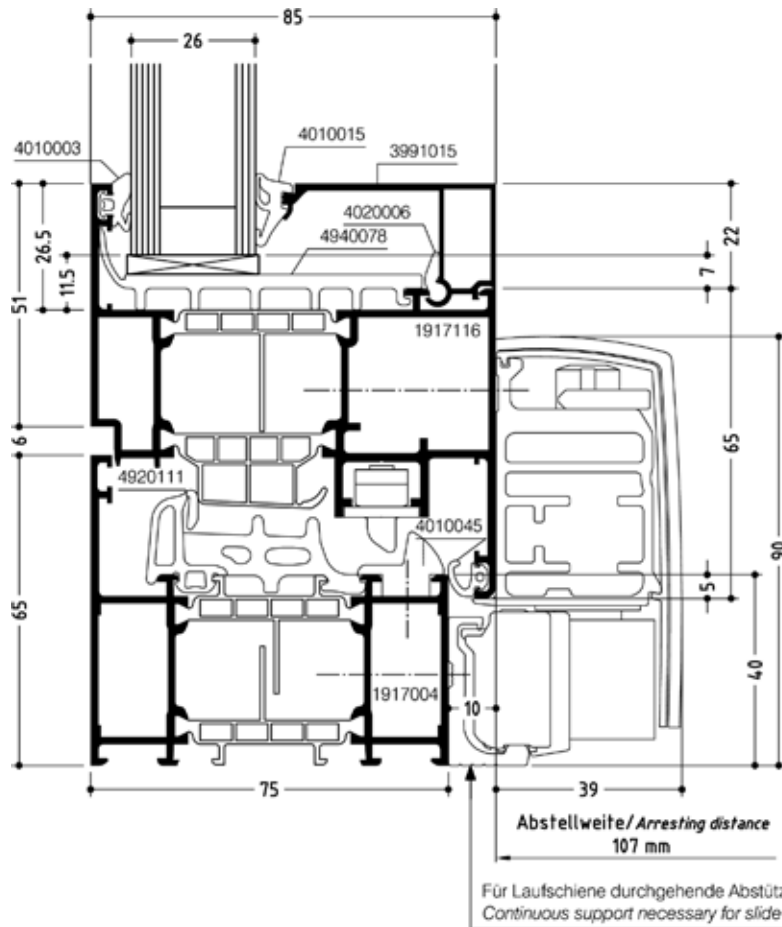

DOC-0000824010

Parallel-Schiebe-
Kipp-Fenster (ohne
Zwangssteuerung)

*Parallel sliding tilt
window (without
force operation)*

WICLINE 65

Kämpferprofil nach innen verstärkt mit Festverglasung
Internally reinforced transom profile with fixed glazing

Konstruktionsschnitt
Construction section

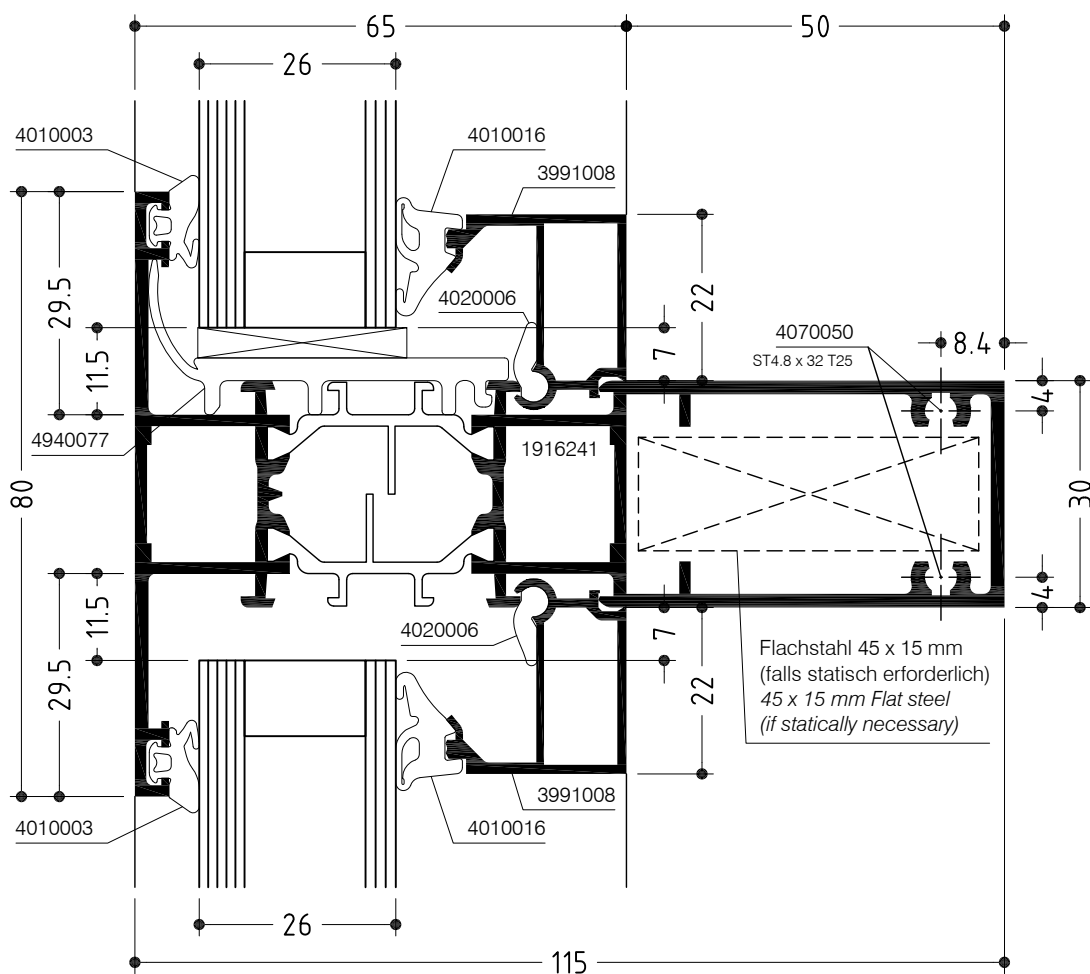

WICLINE 75

Blendrahmen - Dehnstoß und Festverglasung mit Spezial-Dämmprofil
Frame expansion joint and fixed glazing with special insulation profile

Konstruktionsschnitt
Construction section

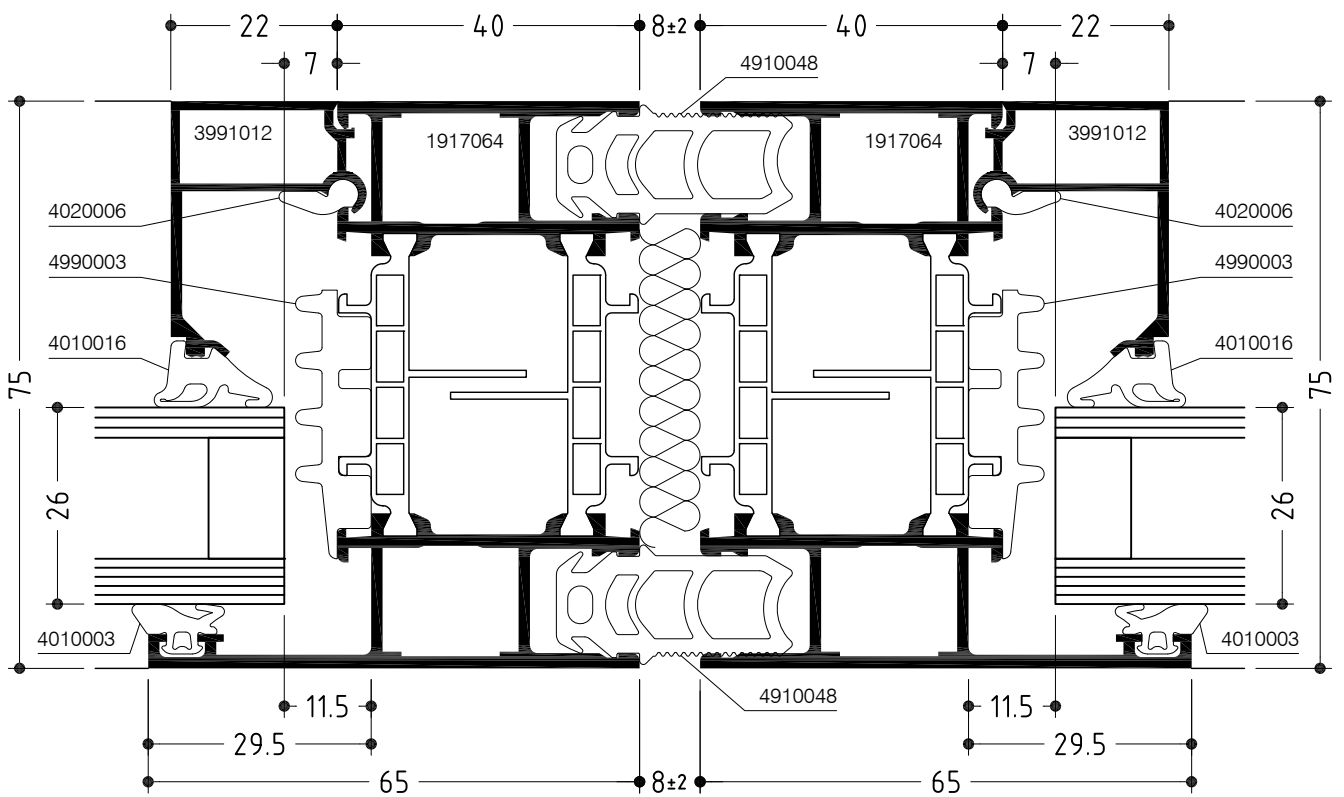
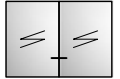

WICLINE 65

Flügelprofil im Blendrahmen mit Spezial-Dämmprofil
Sash profile in frame with special insulation profile

Konstruktionsschnitt
Construction section

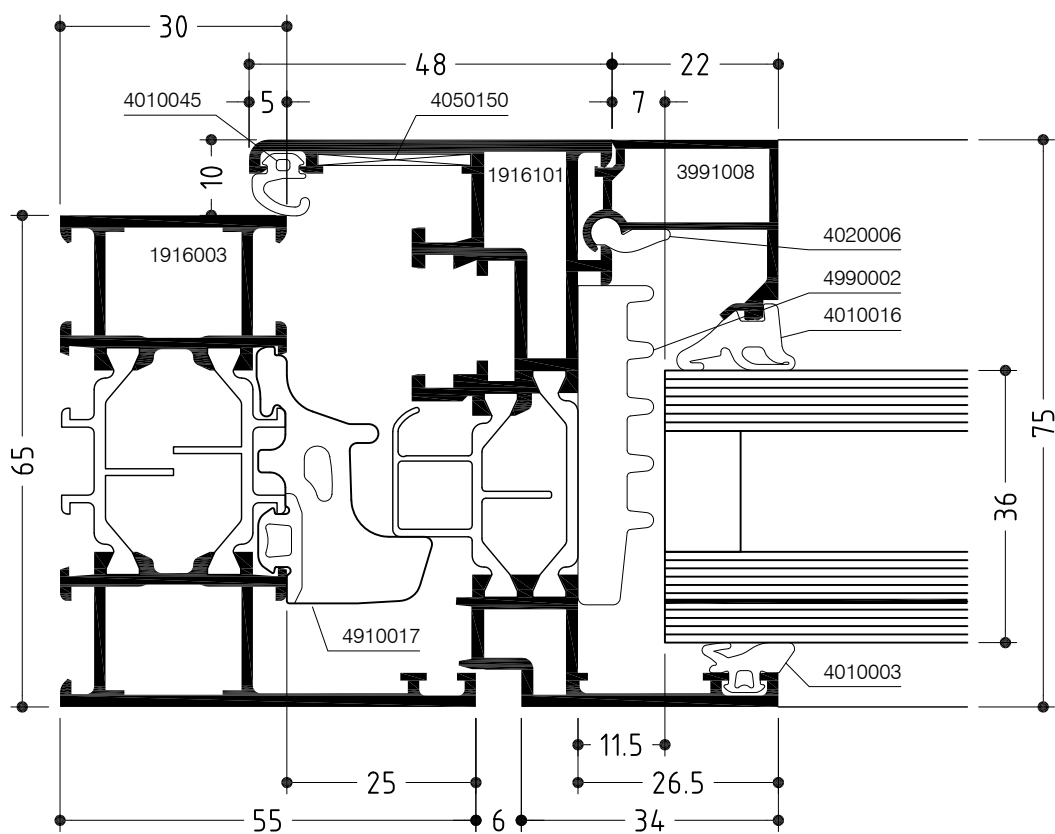
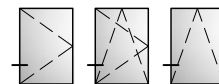

WICLINE 65

Flügelprofil im Blendrahmen mit Kämpfer
Sash profile in frame with transom

Konstruktionsschnitt
Construction section

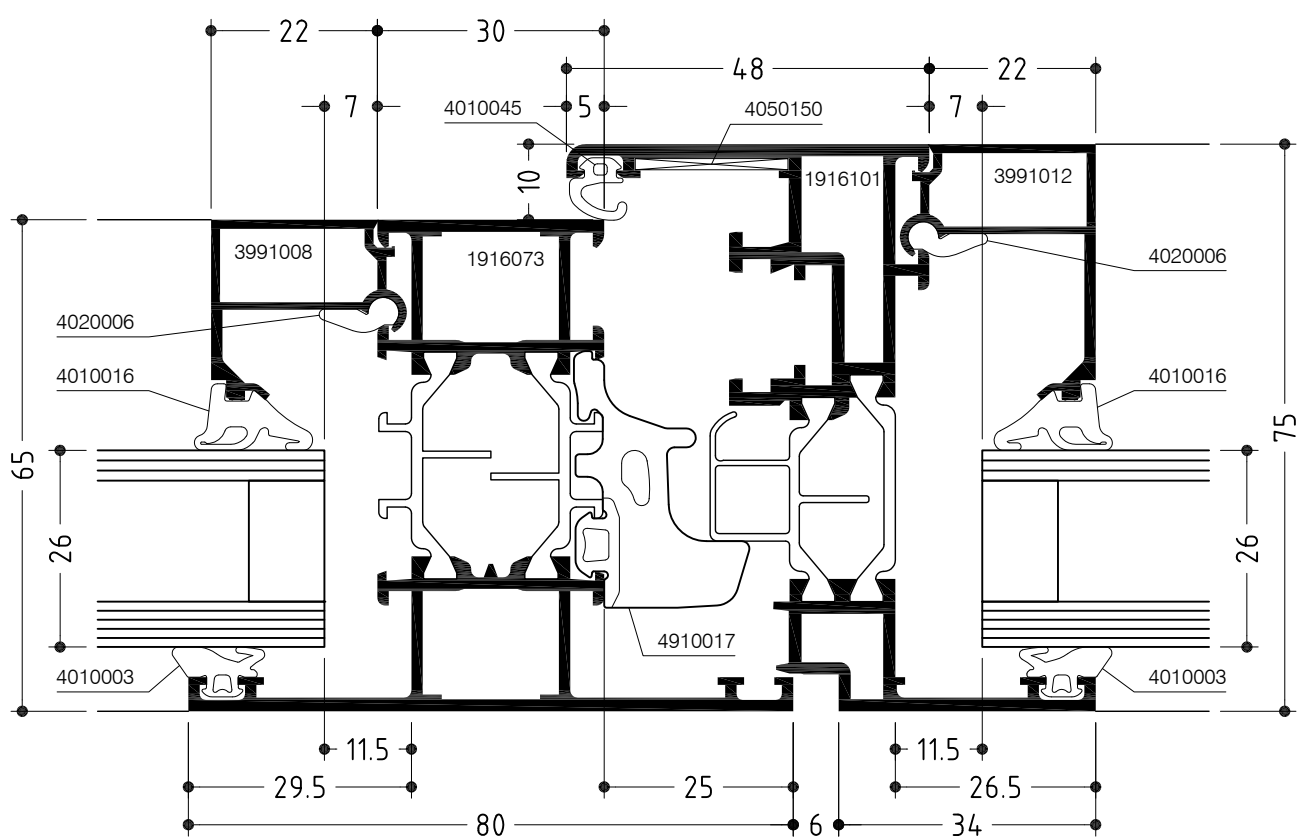
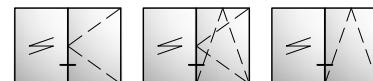

WICLINE 65

Kämpferprofil nach innen verstärkt mit Falzverbreiterung
Internally reinforced transom profile with rebate widening

Konstruktionsschnitt
Construction section

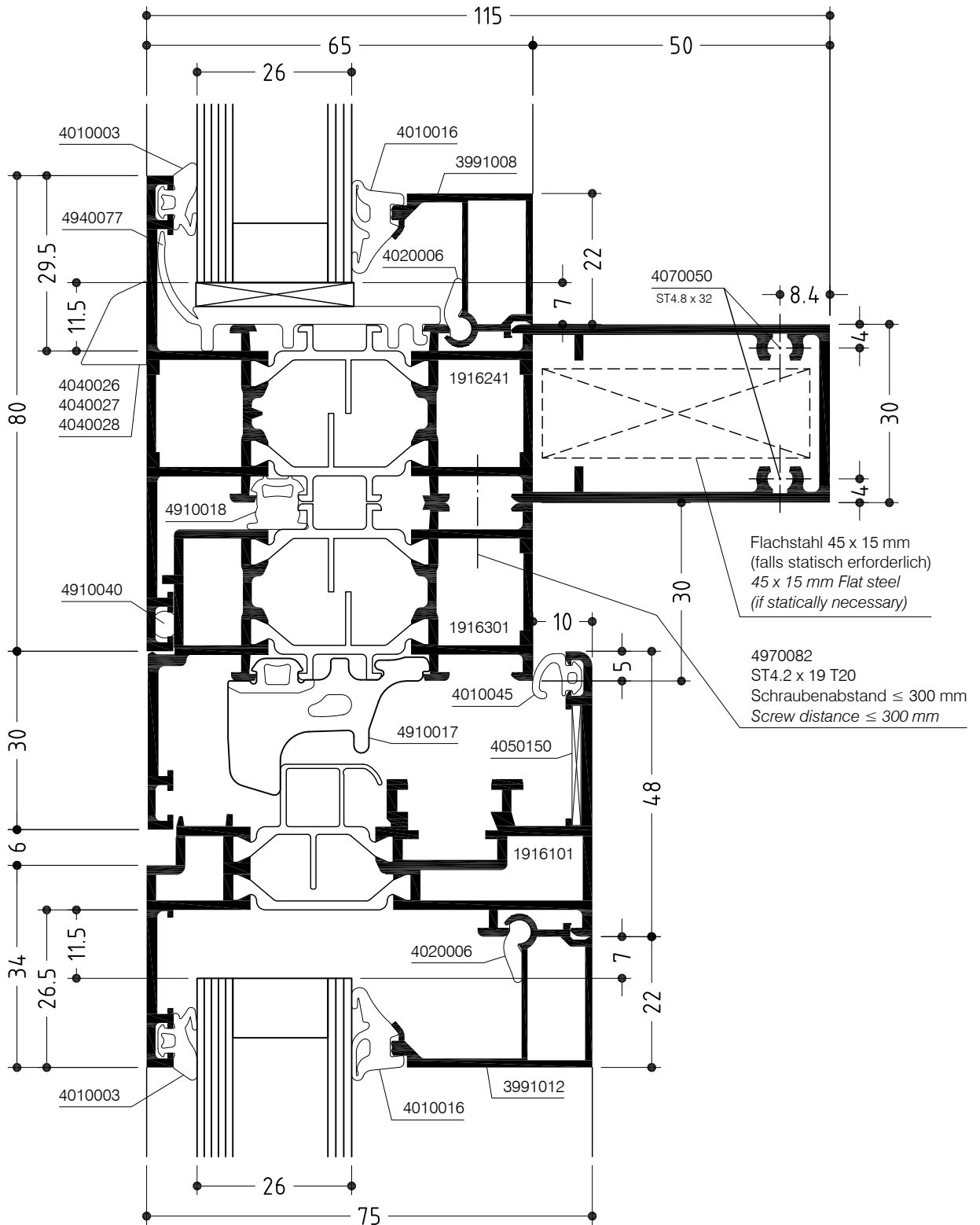
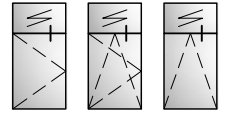

WICLINE 65

Stützenprofile nach außen verstärkt
Externally reinforced mullion profiles

Konstruktionsschnitt
Construction section

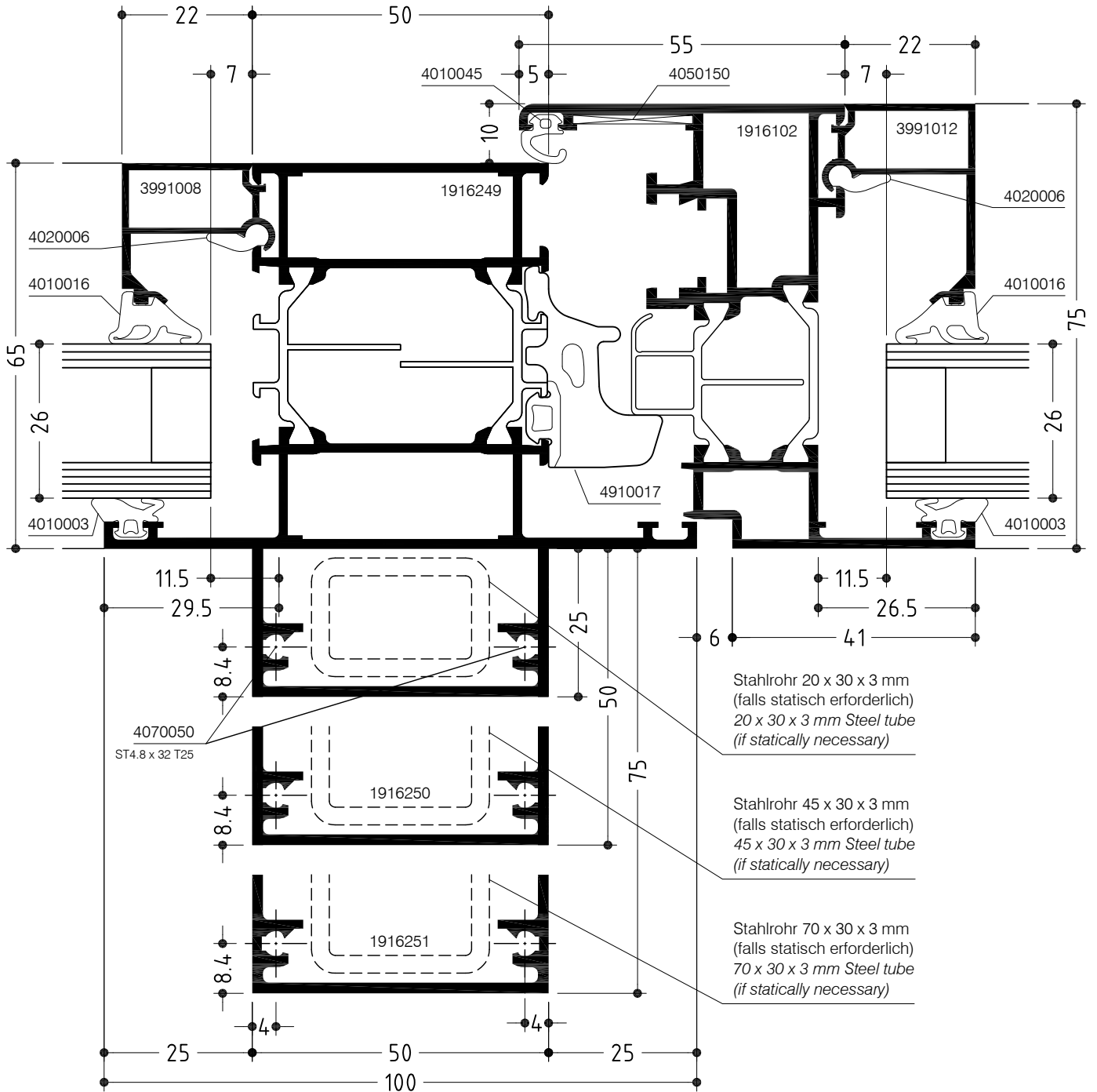
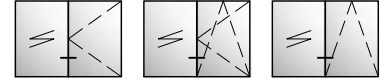

WICLINE 65

Stützenprofile geteilt, nach außen verstärkt
Externally reinforced split mullion profiles

Konstruktionsschnitt
Construction section

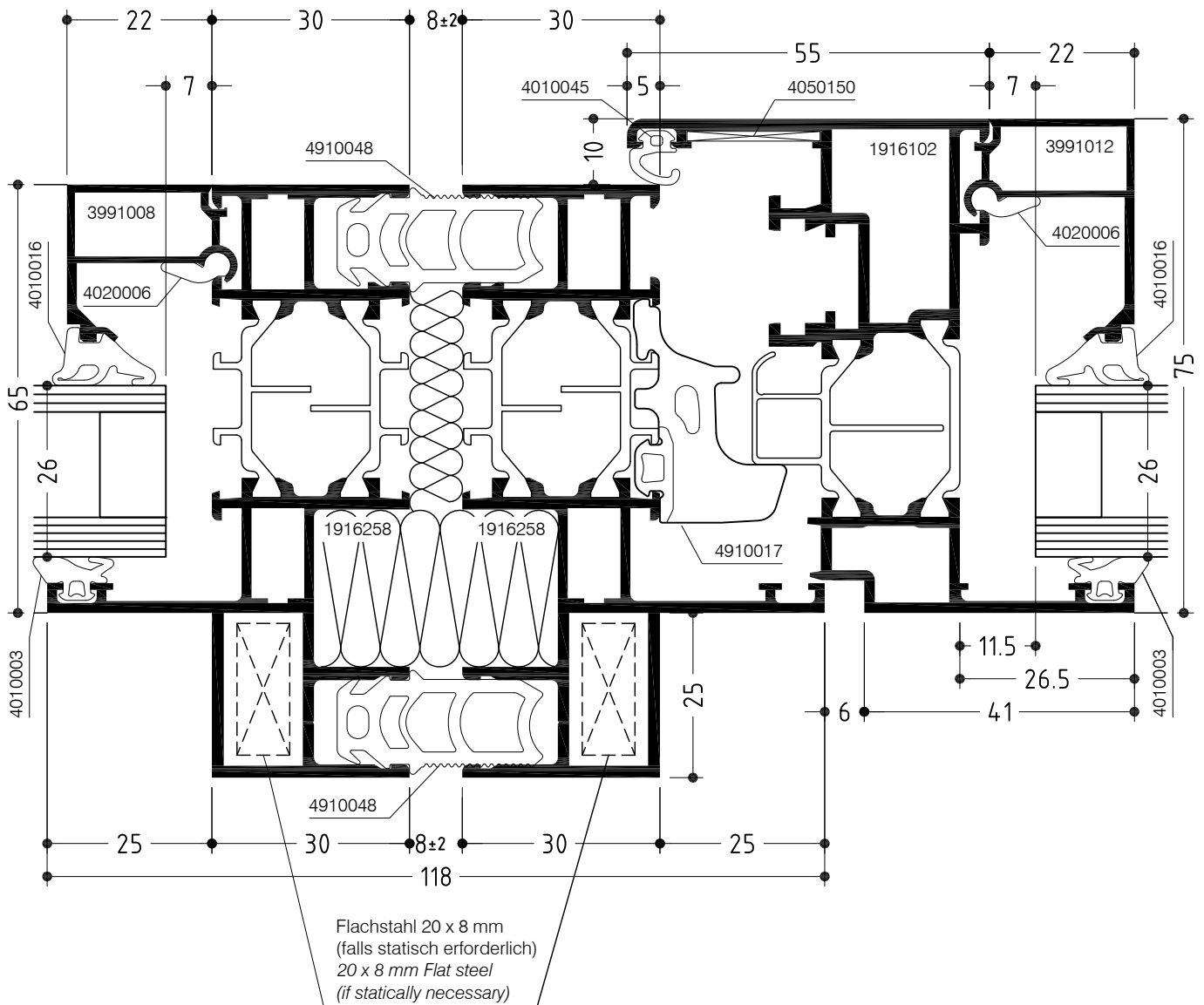
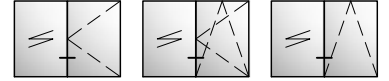

WICLINE 65

Eckstützenprofil - Außenecke 90°
 Corner mullion profile of 90° outer corner

Konstruktionsschnitt
 Construction section

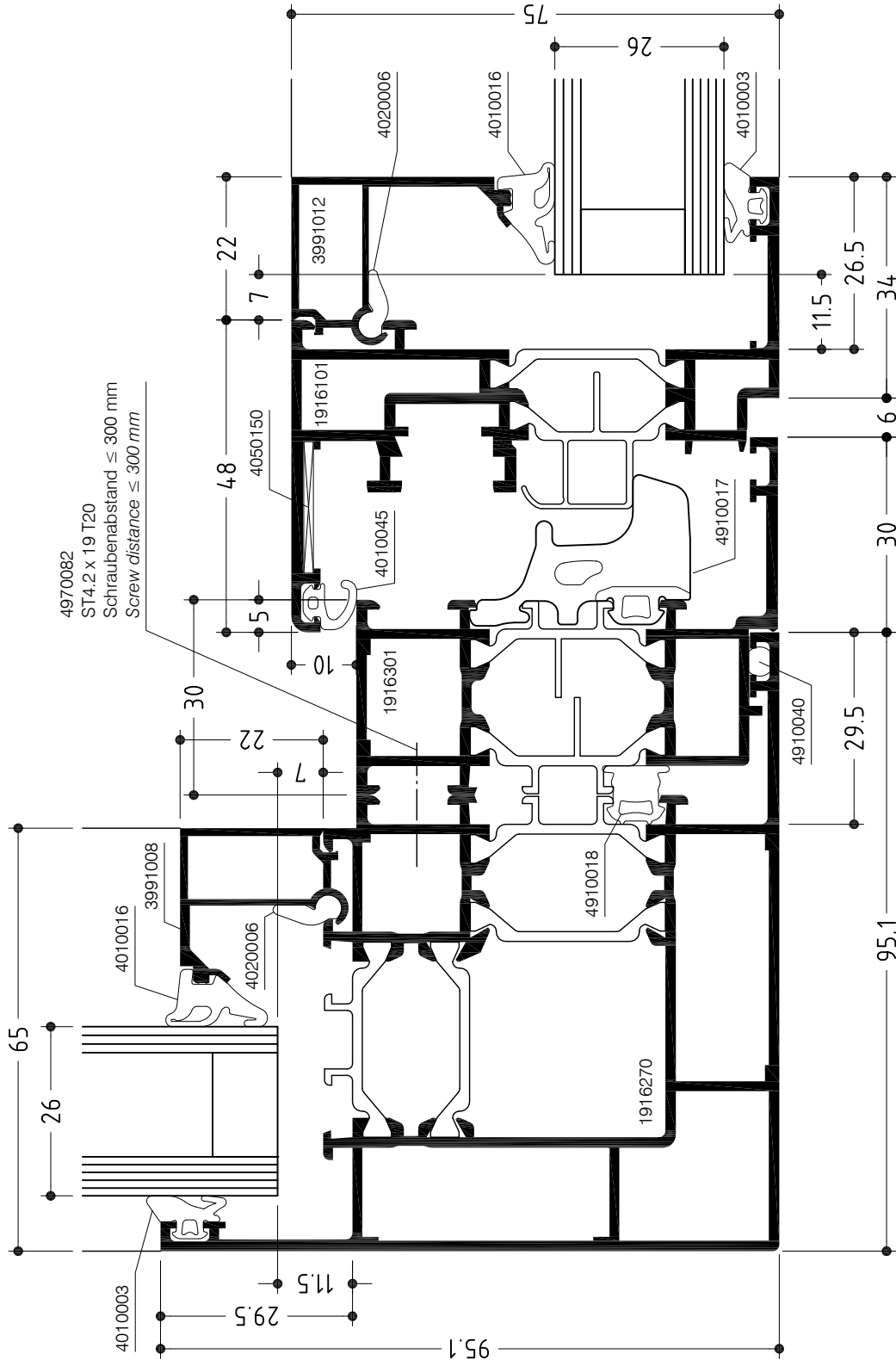
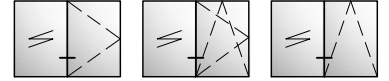

WICLINE 65

Kämpferprofil mit Plattenmontage von außen
Transom profile with panel assembly from outside

Konstruktionsschnitt
Construction section

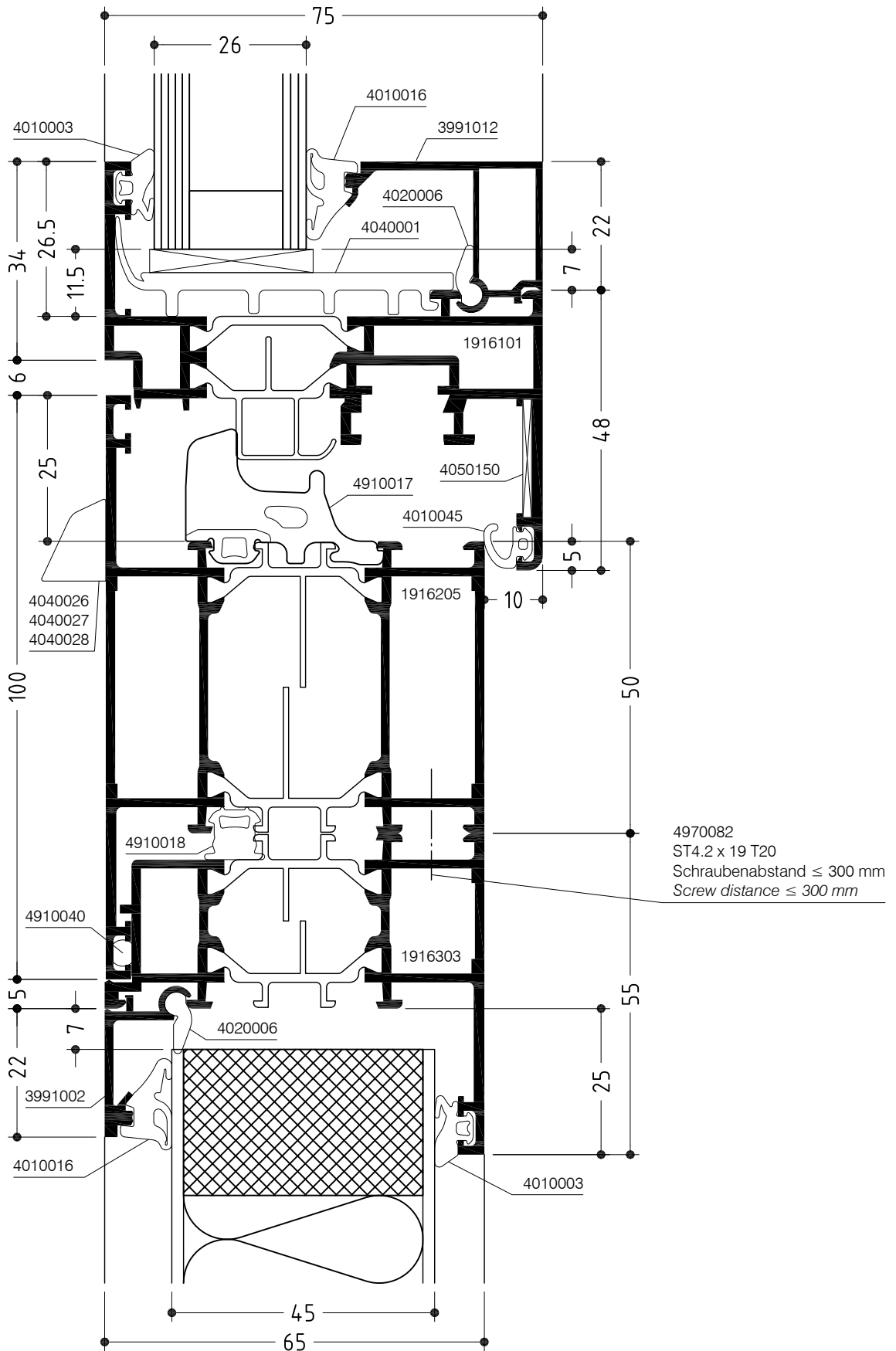
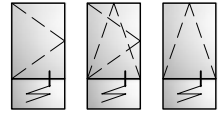

WICLINE 65

Konstruktionsschnitt

Construction section

Bauanschluss unten mit Dämmauflage 4930042

Bottom junction to structure with insulation support 4930042

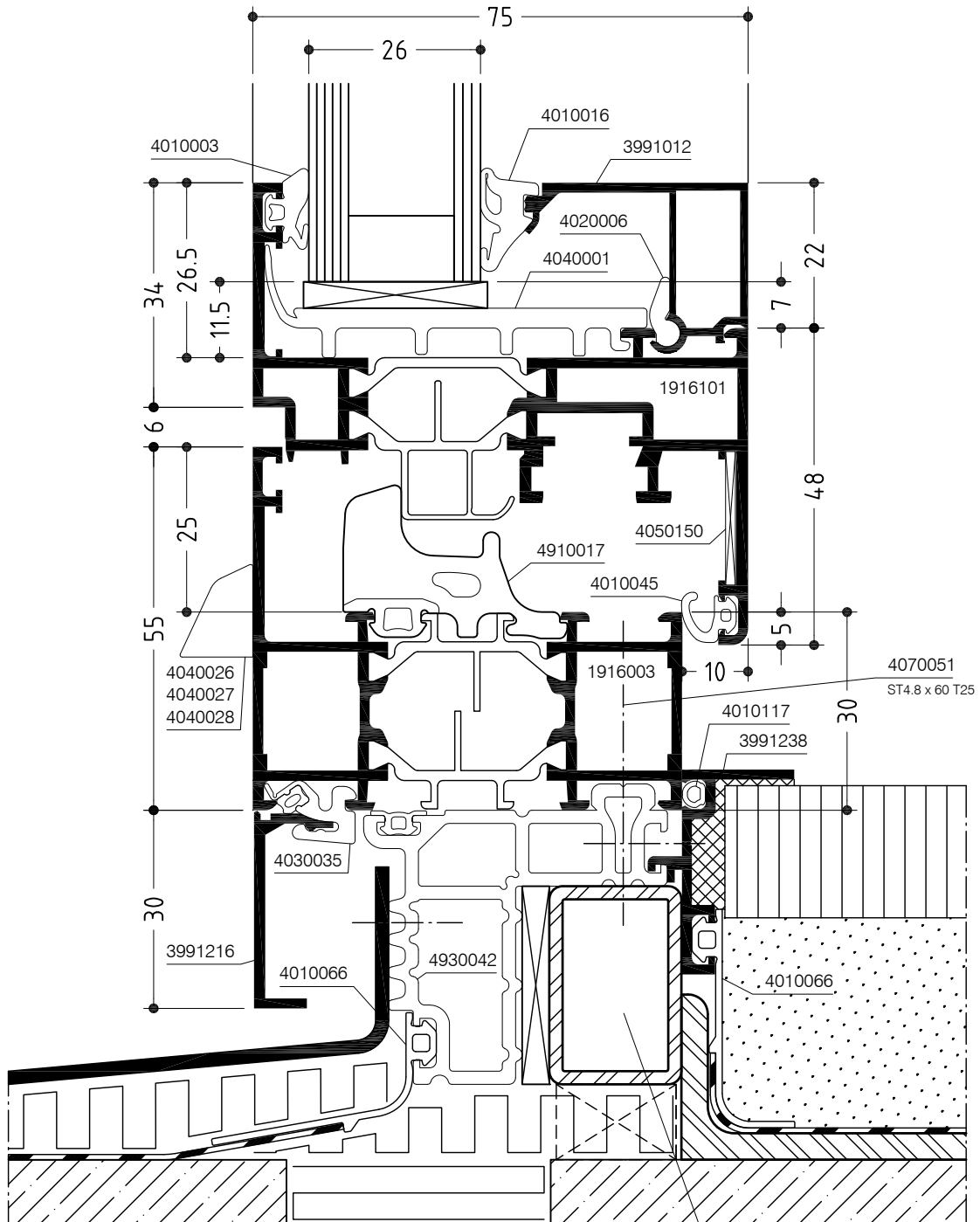

Stahlrohr 20 x 30 x 2
 verzinkt nach DIN 55928
 20 x 30 x 2 Steel tube,
 galv. acc. to DIN 55928

WICLINE 65

Bauanschluss unten mit Dämmauflage 4930043
Bottom junction to structure with insulation support 4930043

Konstruktionsschnitt
Construction section

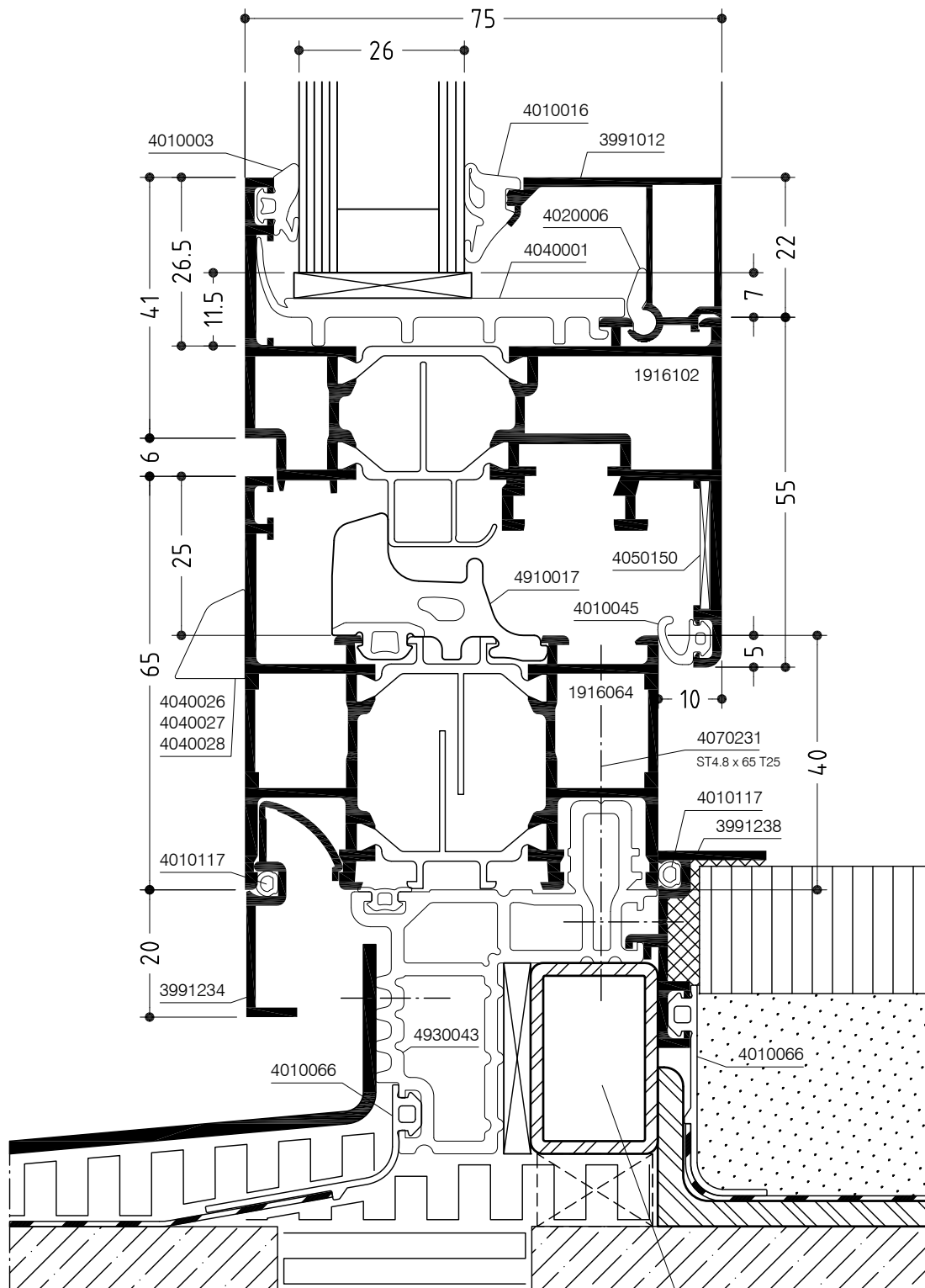

Stahlrohr 20 x 30 x 2
verzinkt nach DIN 55928
20 x 30 x 2 Steel tube,
galv. acc. to DIN 55928

WICLINE 75

Flügelprofil im Blendrahmen mit Spezial-Dämmprofil

Sash profile in frame with special insulation profile

Konstruktionsschnitt

Construction section

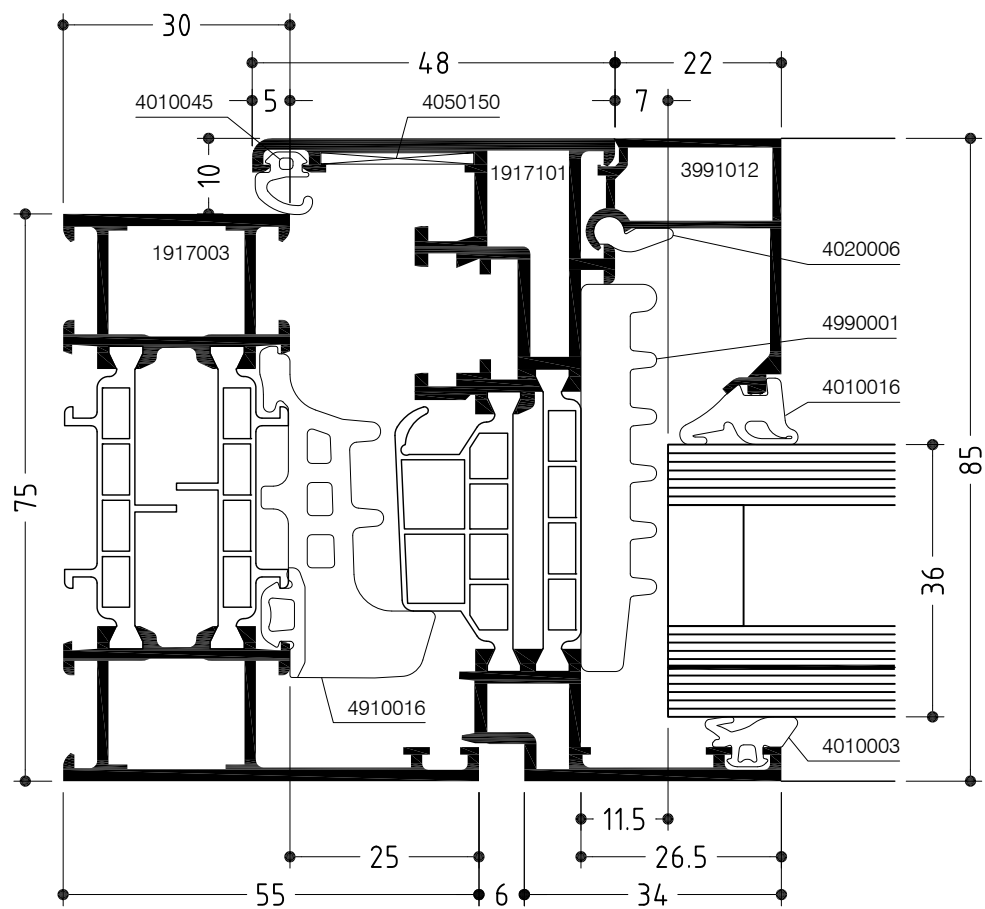

WICLINE 75

Stulpfenster - Mittelstoß

Double casement window - Meeting stiles

Konstruktionsschnitt

Construction section

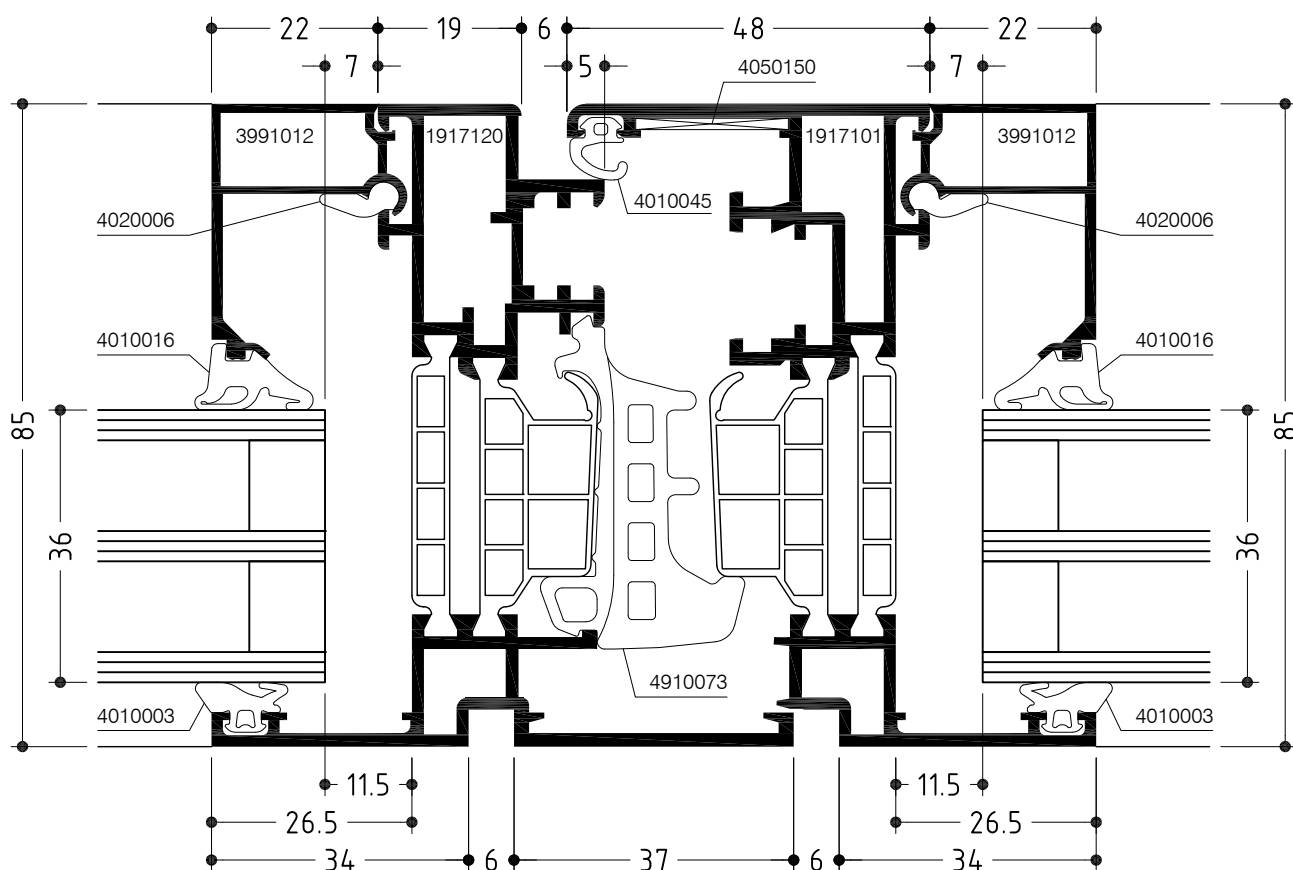
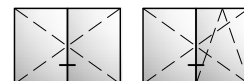

WICLINE 75

Flügelprofil im Blendrahmen mit Kämpfer
Sash profile in frame with transom

Konstruktionsschnitt
Construction section

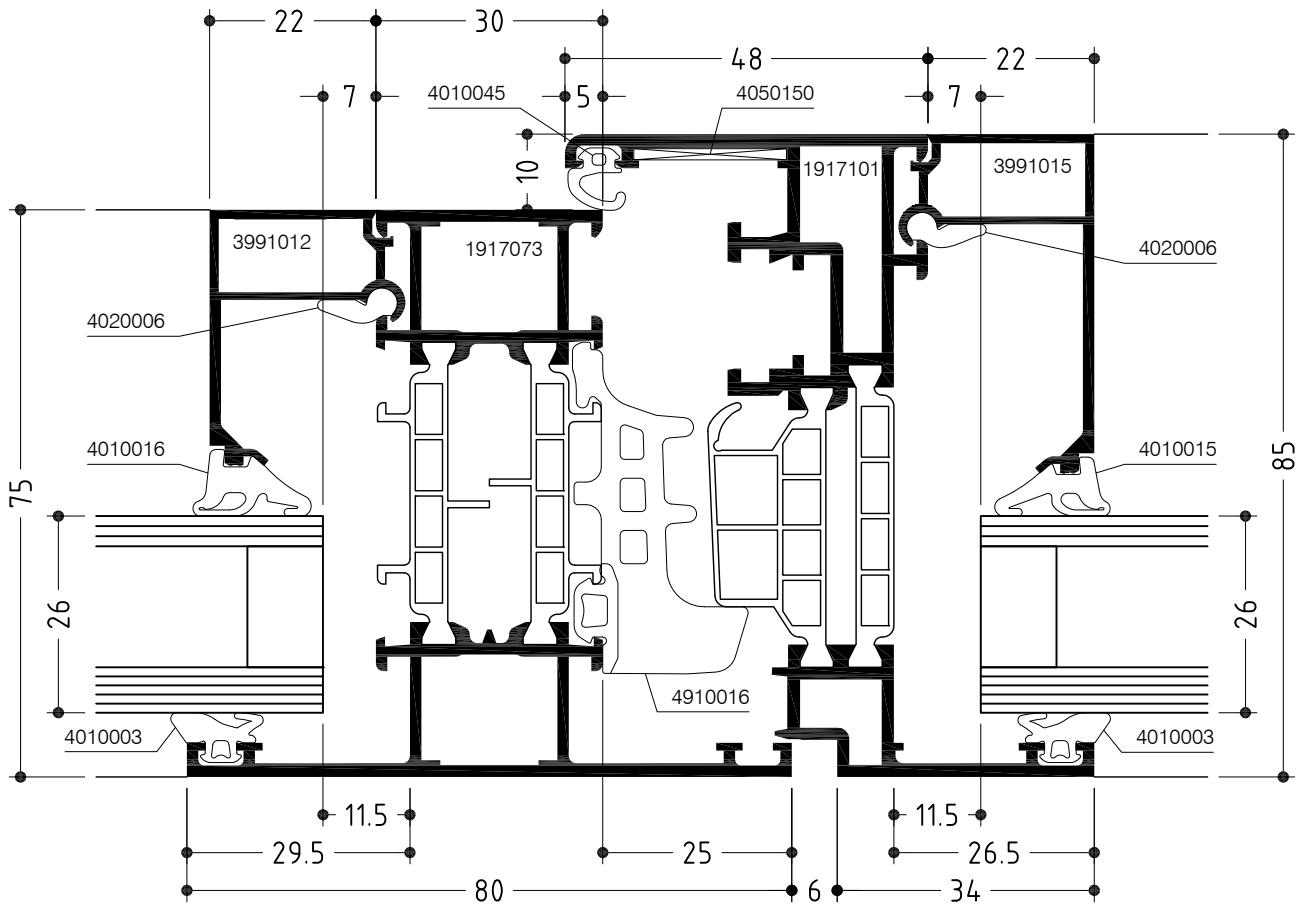
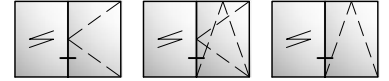

WICLINE 75

Flügelprofil im Blendrahmen mit Sprossenprofil
Sash profile in frame with crossbar profile

Konstruktionsschnitt
Construction section

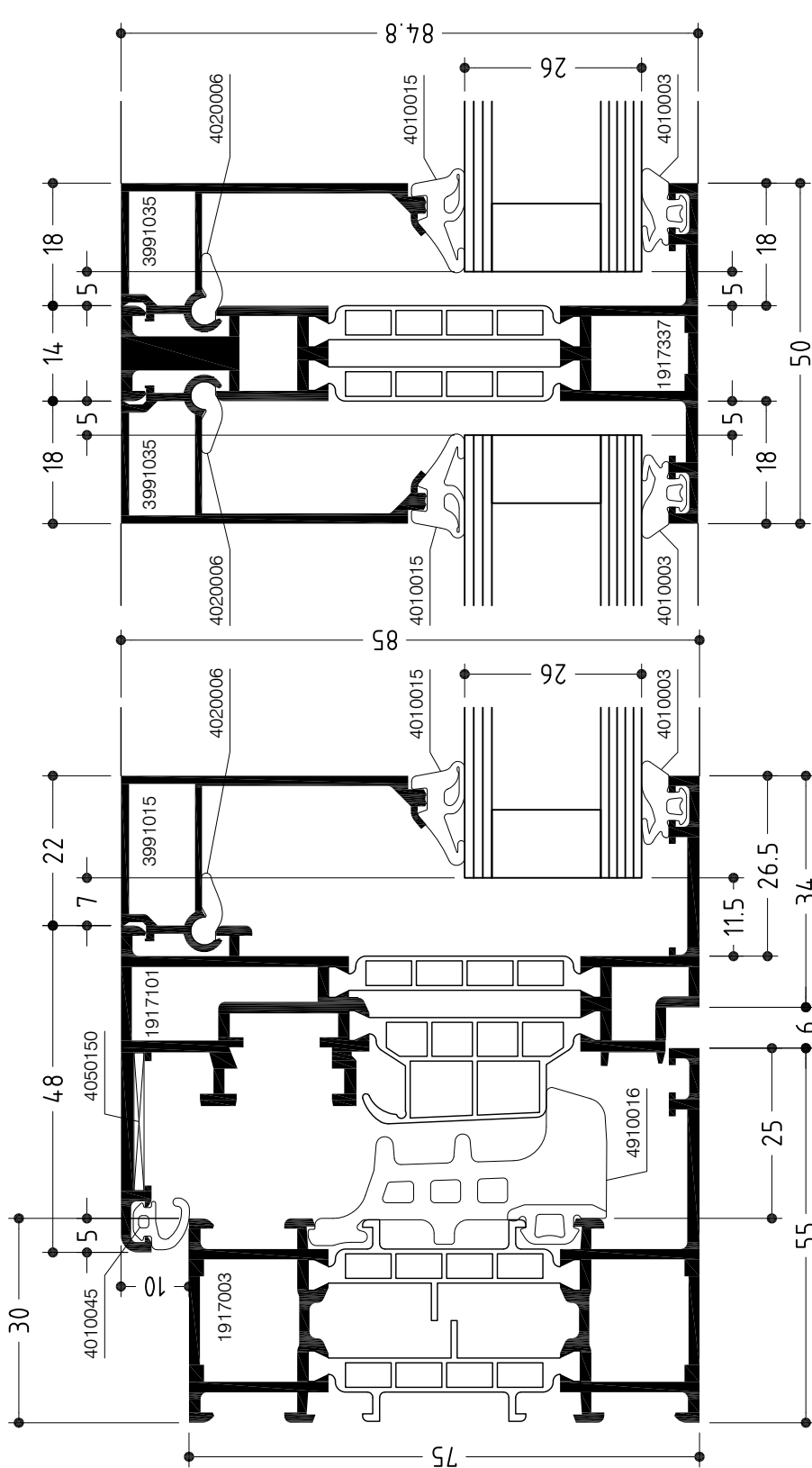

Schnitt 90° gedreht
Section turned by 90°

WICLINE 75

Stützenprofile nach außen verstärkt
Externally reinforced mullion profiles

Konstruktionsschnitt
Construction section

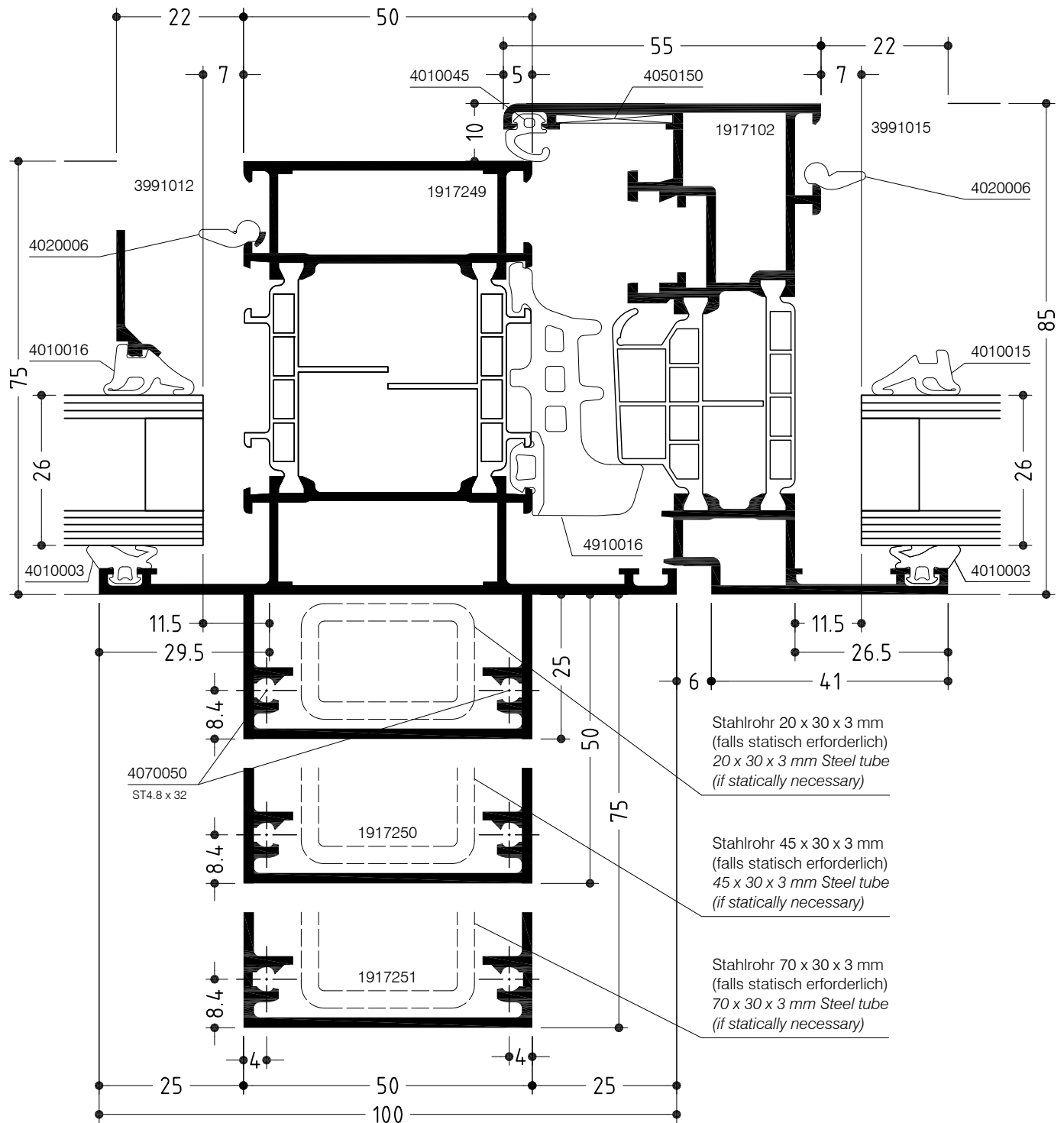
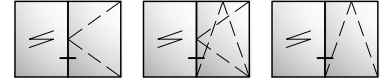

WICLINE 75

Kämpferprofile nach außen verstärkt
Externally reinforced transom profiles

Konstruktionsschnitt
Construction section

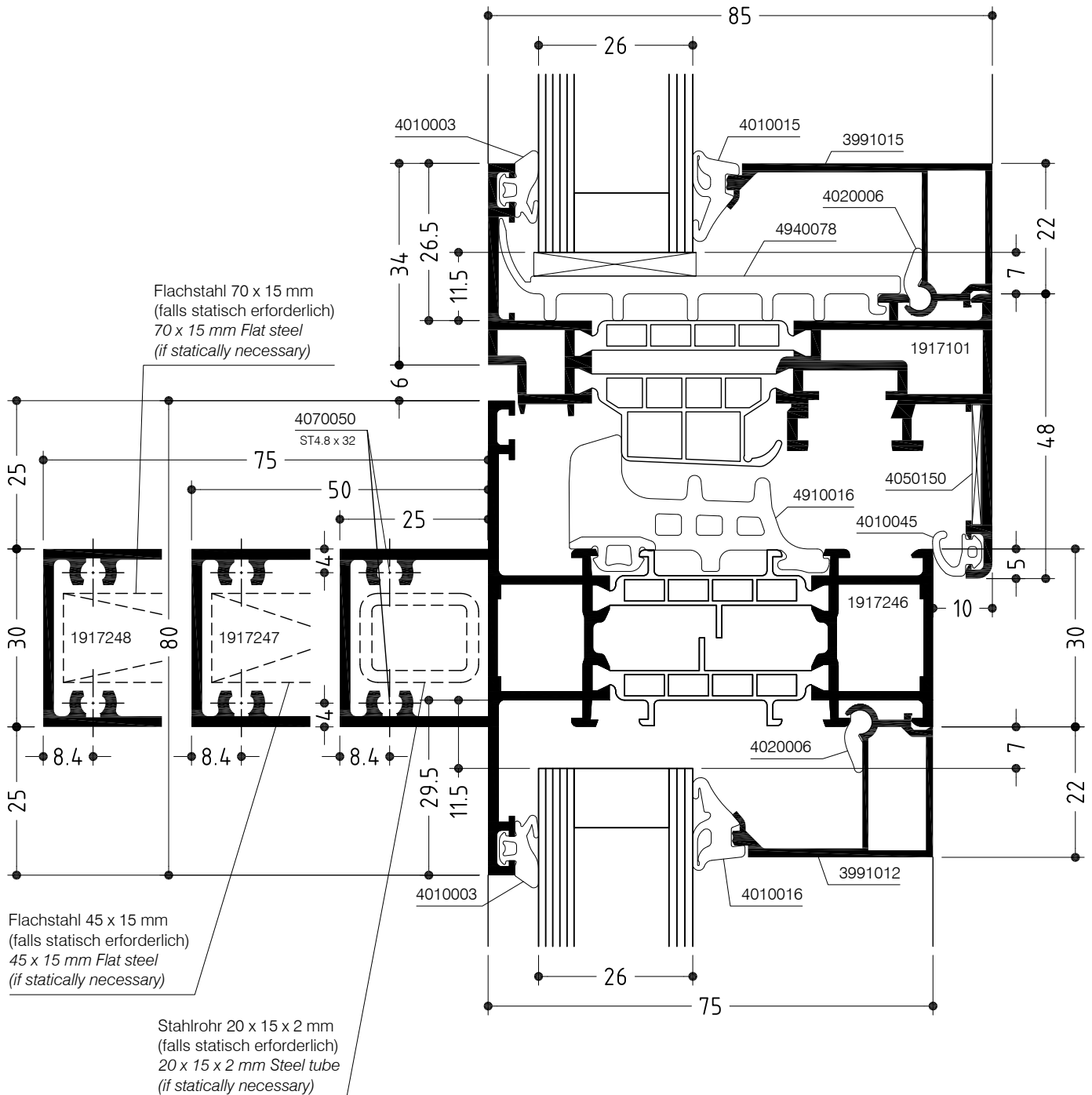
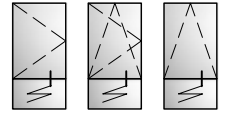

WICLINE 75

Stützenprofile geteilt, nach außen verstärkt
 Externally reinforced split mullion profiles

Konstruktionsschnitt
 Construction section

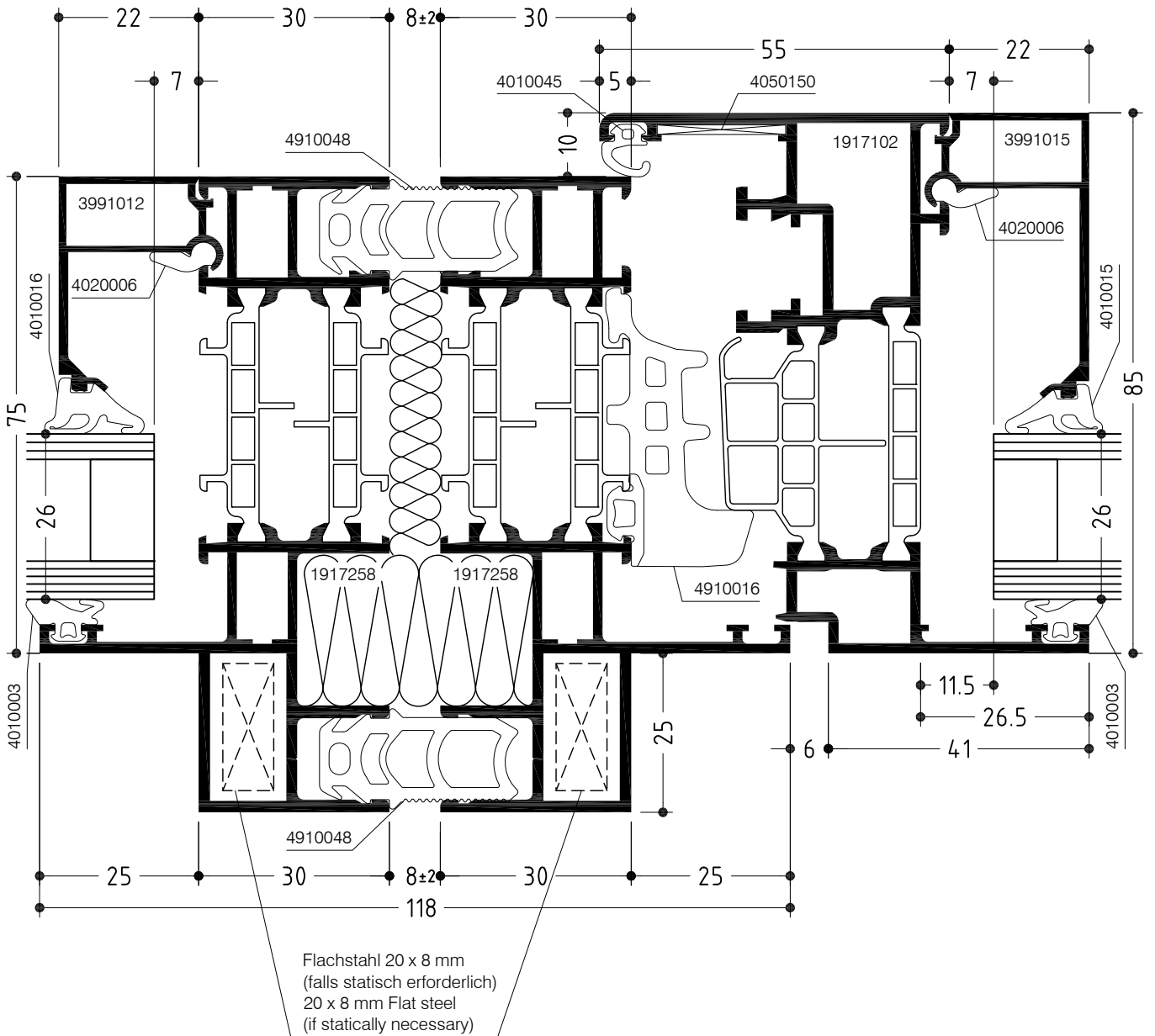
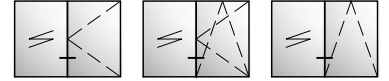

WICLINE 75

Stützenprofile geteilt, nach außen verstärkt
Externally reinforced split mullion profiles

Konstruktionsschnitt
Construction section

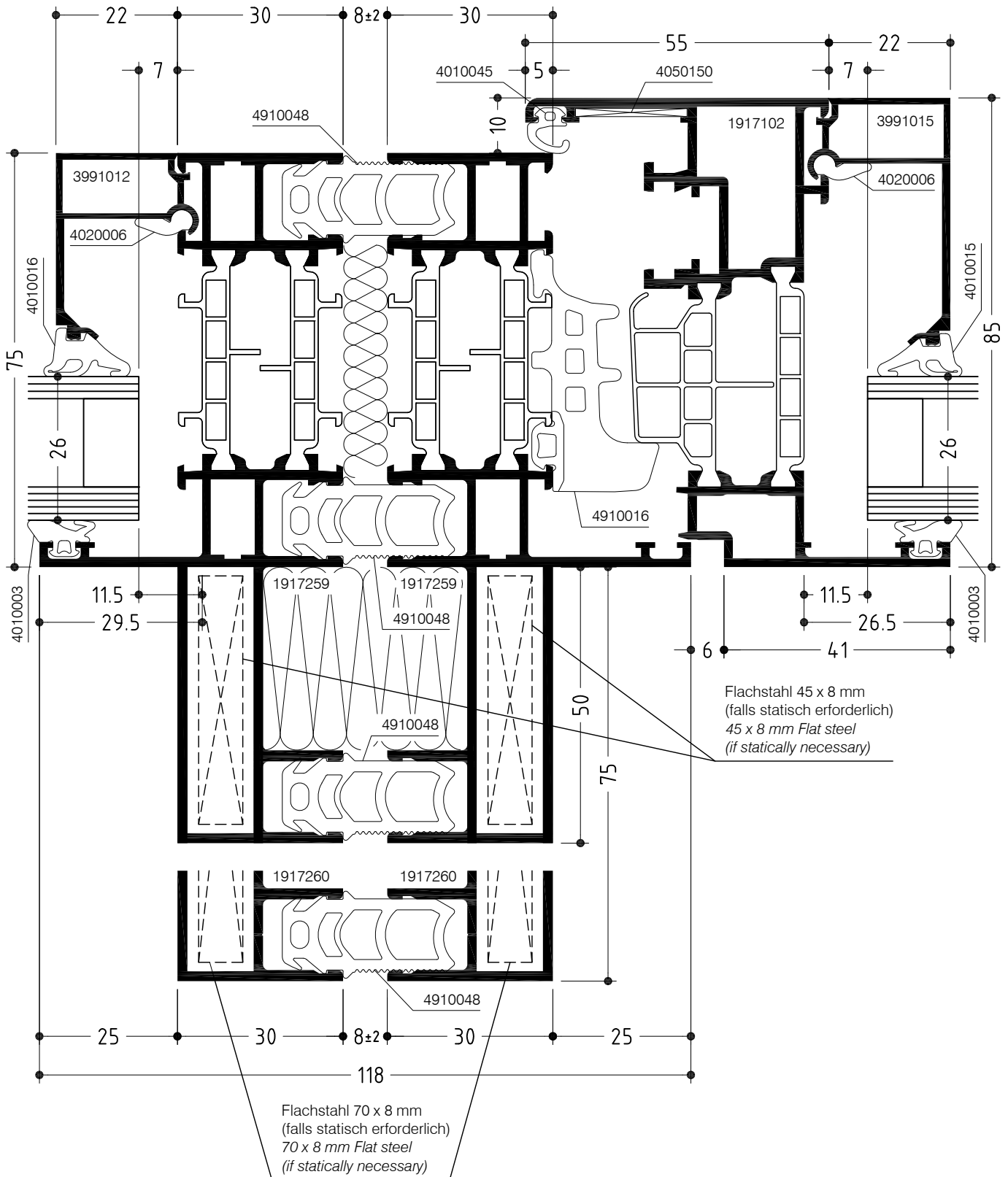
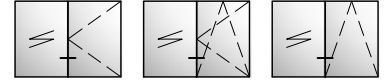

WICLINE 75

Eckstützenprofil - Außenecke 90°
 Corner mullion profile of 90° outer corner

Konstruktionsschnitt
 Construction section

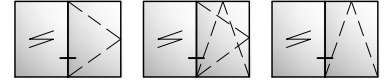

Schnitt 90° gedreht
 Section turned by 90°

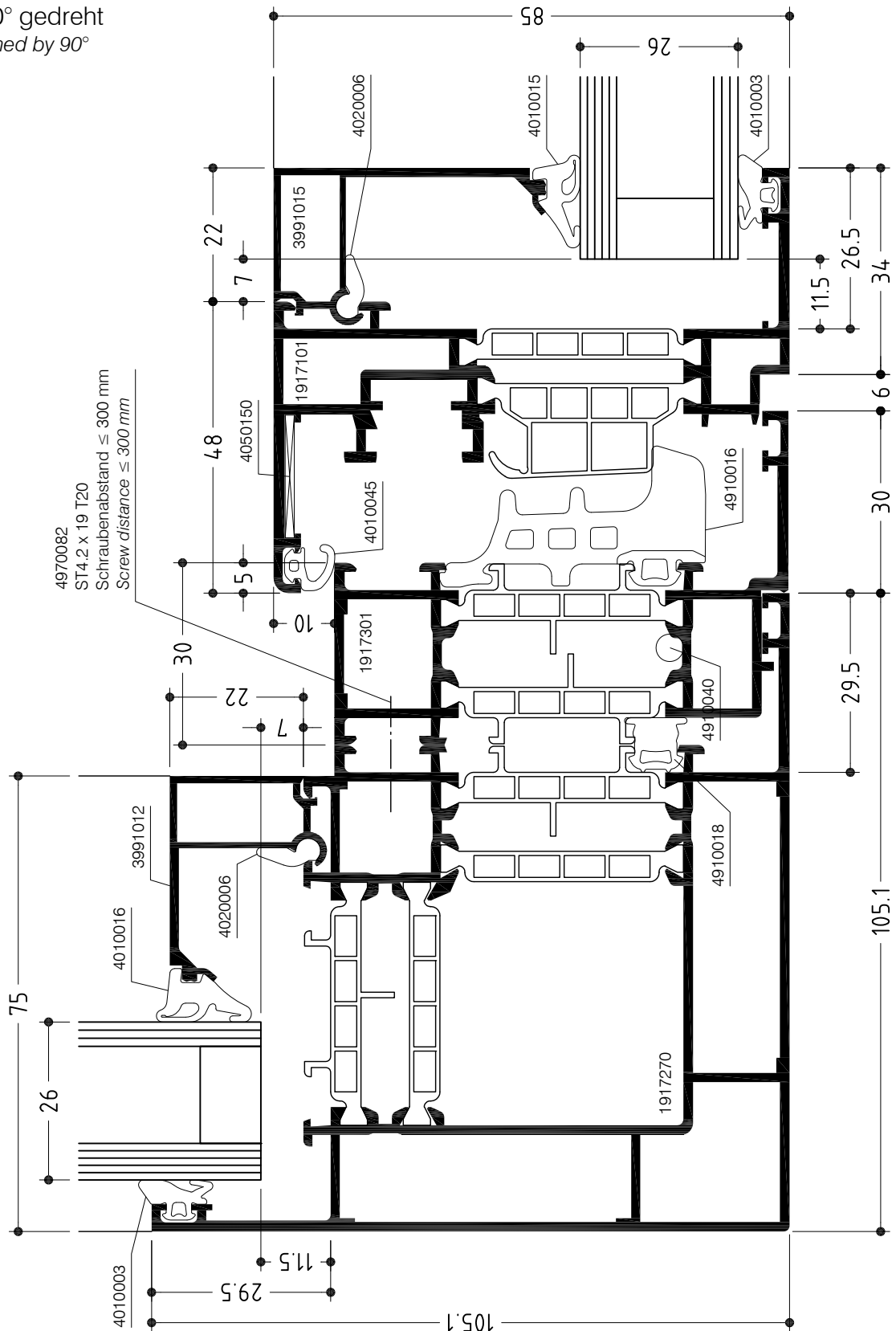

WICLINE 75

Kämpferprofil mit Plattenmontage von außen

Transom profile with panel assembly from outside

Konstruktionsschnitt

Construction section

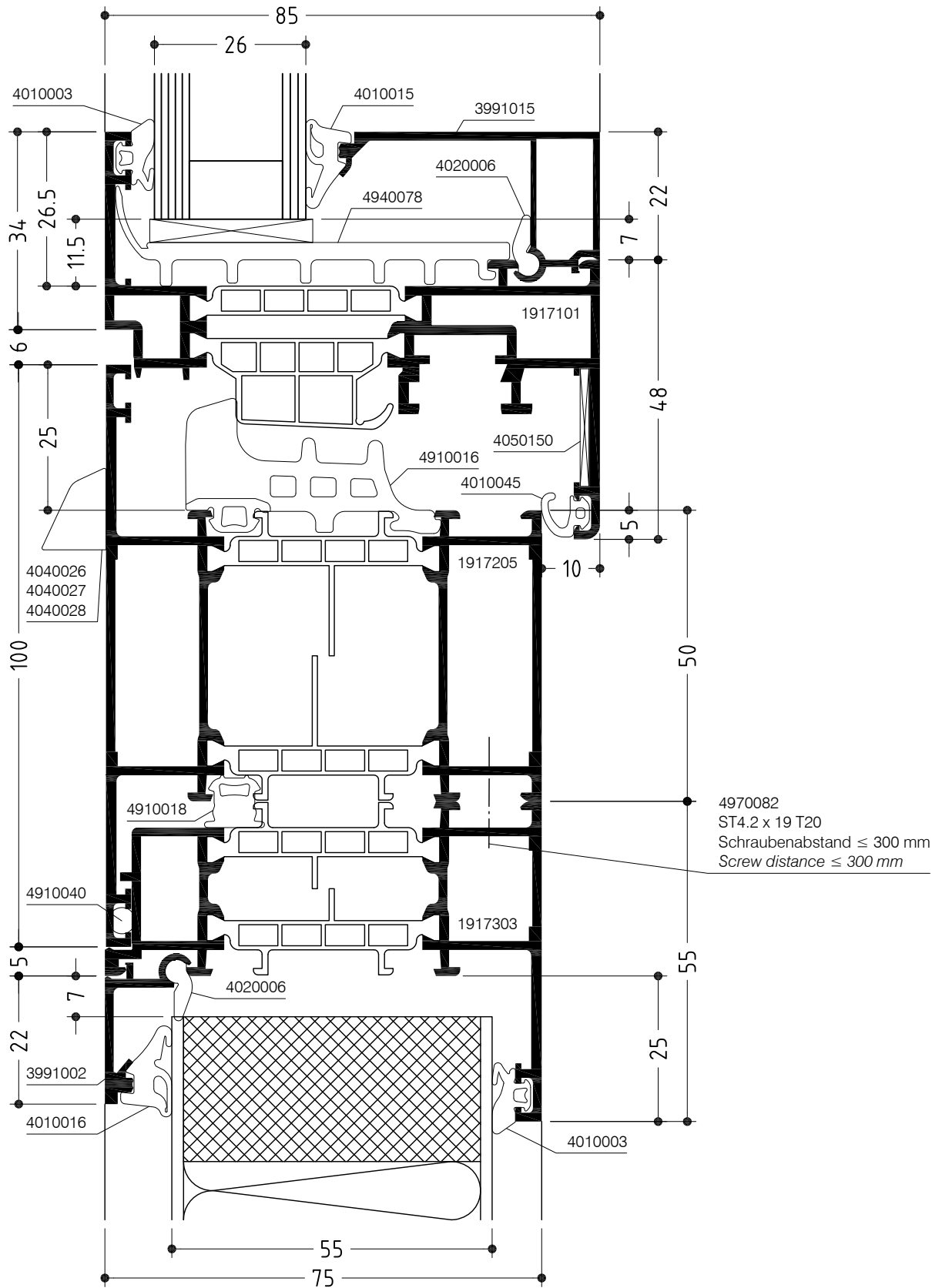
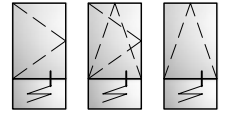

WICLINE 75

Flügelprofil im Blendrahmen mit Bauanschlussprofil 1917307

Sash profile in frame with profile 1917307 for junction to structure

Konstruktionsschnitt

Construction section

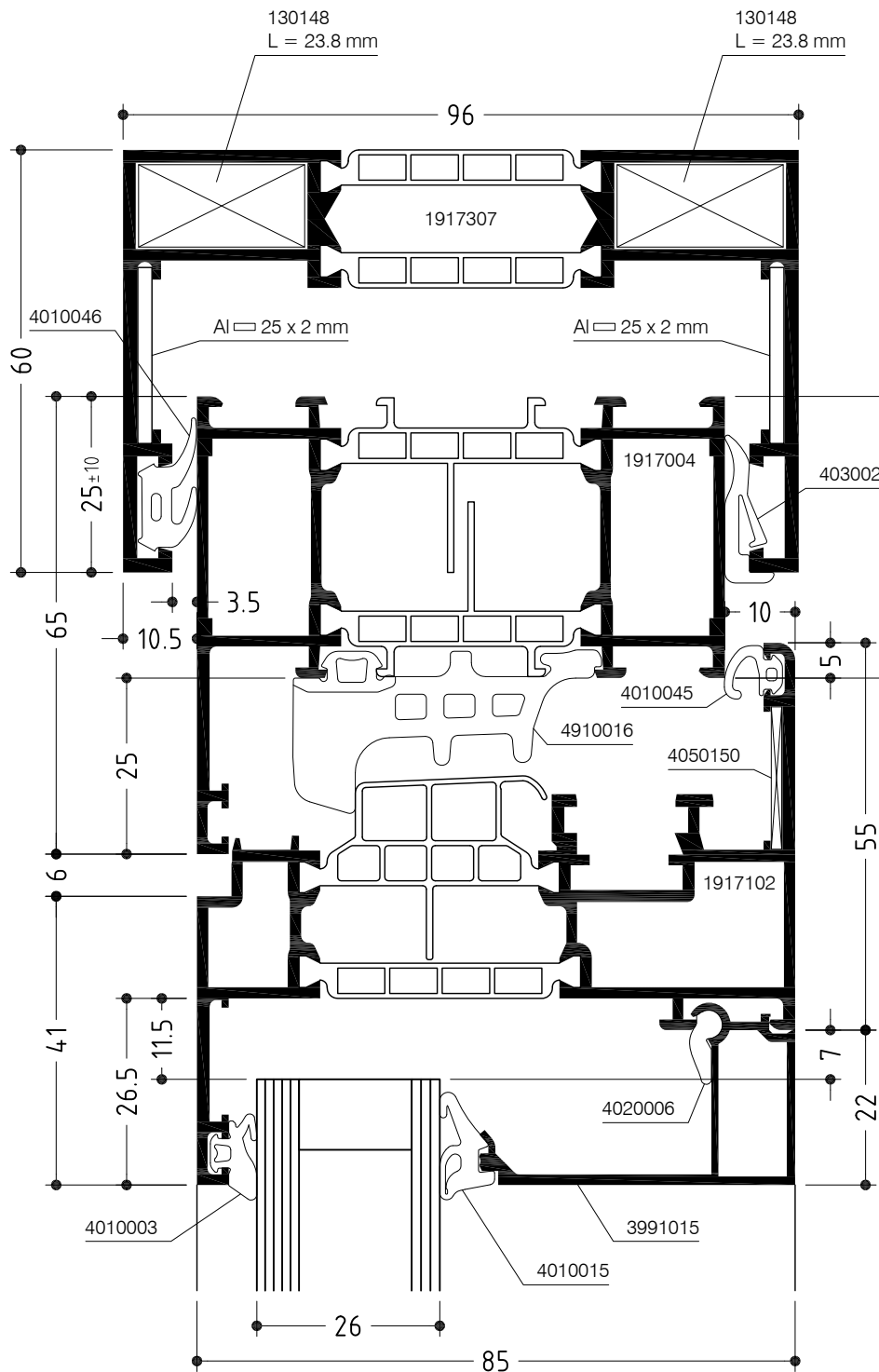

Auf Platzbedarf aufragender
Beschlüge wie Bänder, Oberlicht-
öffner usw. achten.
*Pay attention to space required for
fittings such as hinges, fanlight
opener etc.*

WICLINE 75

Eckstützenprofil - Innenecke 90°
Corner mullion profile of 90° inner corner

Konstruktionsschnitt
Construction section

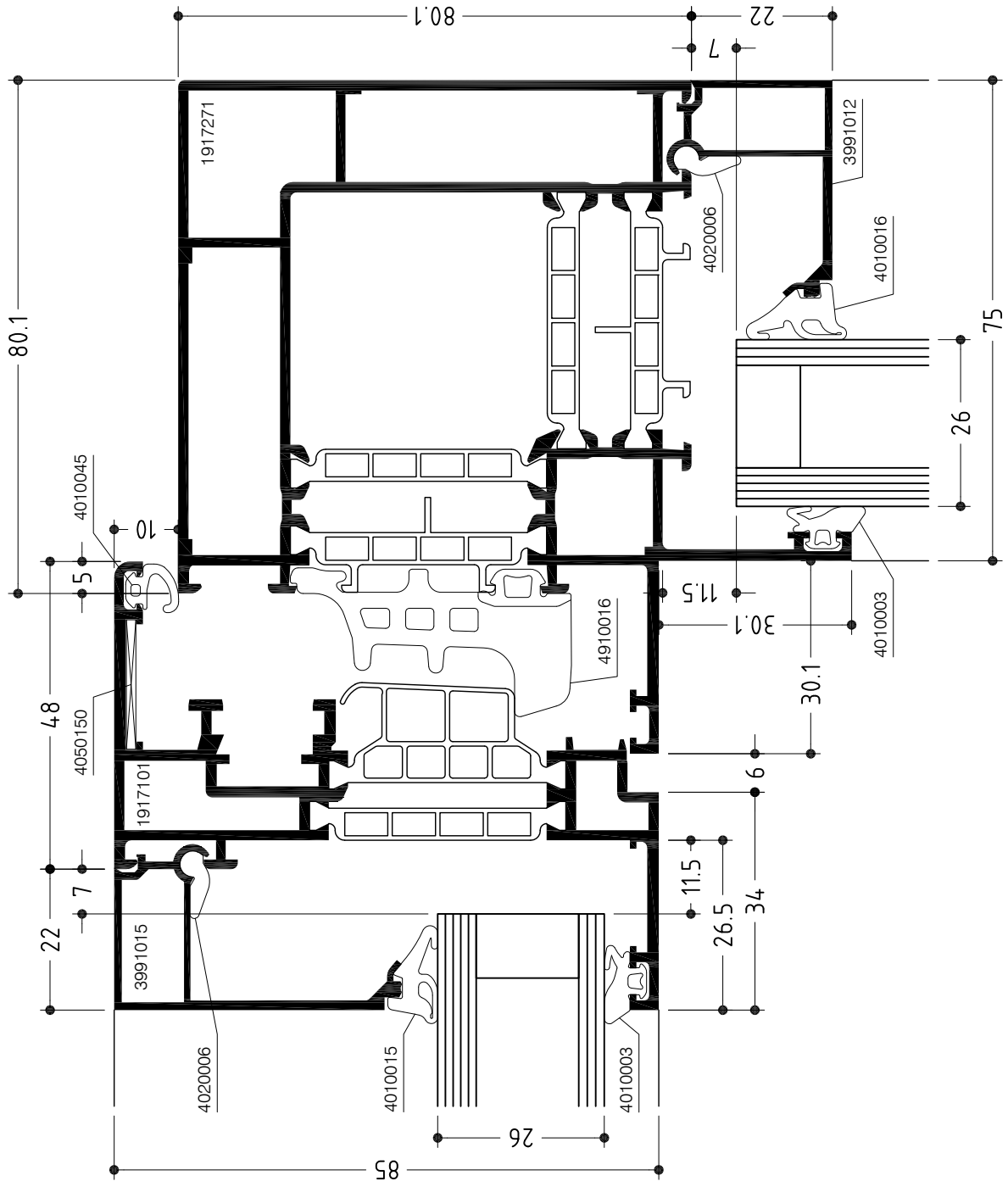
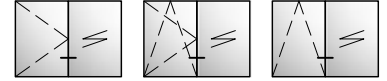

WICLINE 75

Flügelprofil im Blendrahmen mit Einspannaufsatz
Sash profile in frame with supplementary clamping profile

Konstruktionsschnitt
Construction section

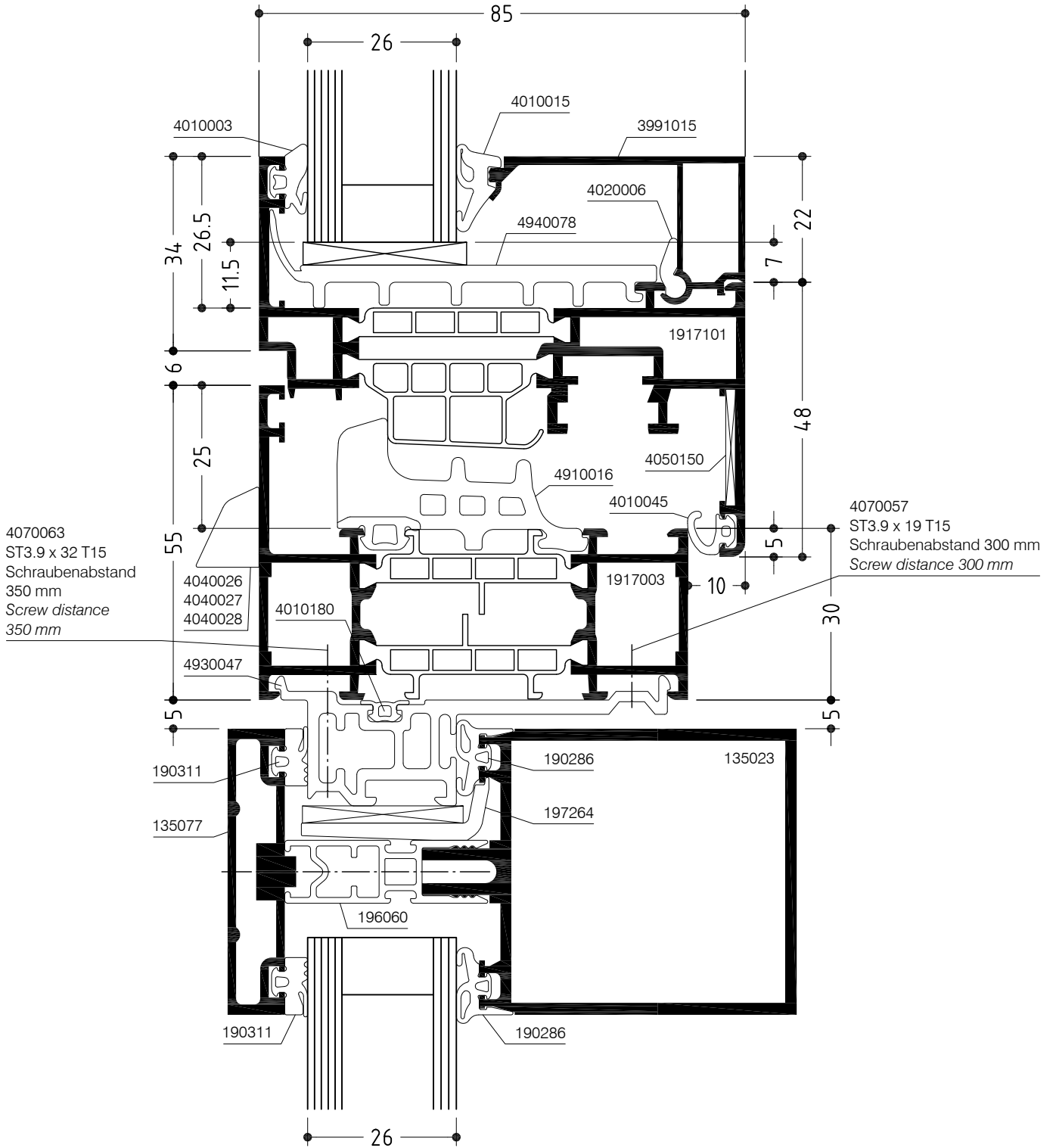

WICLINE 75

Flügelprofil im Blendrahmen, verdeckter Flügel
Concealed sash in frame

Konstruktionsschnitt
Construction section

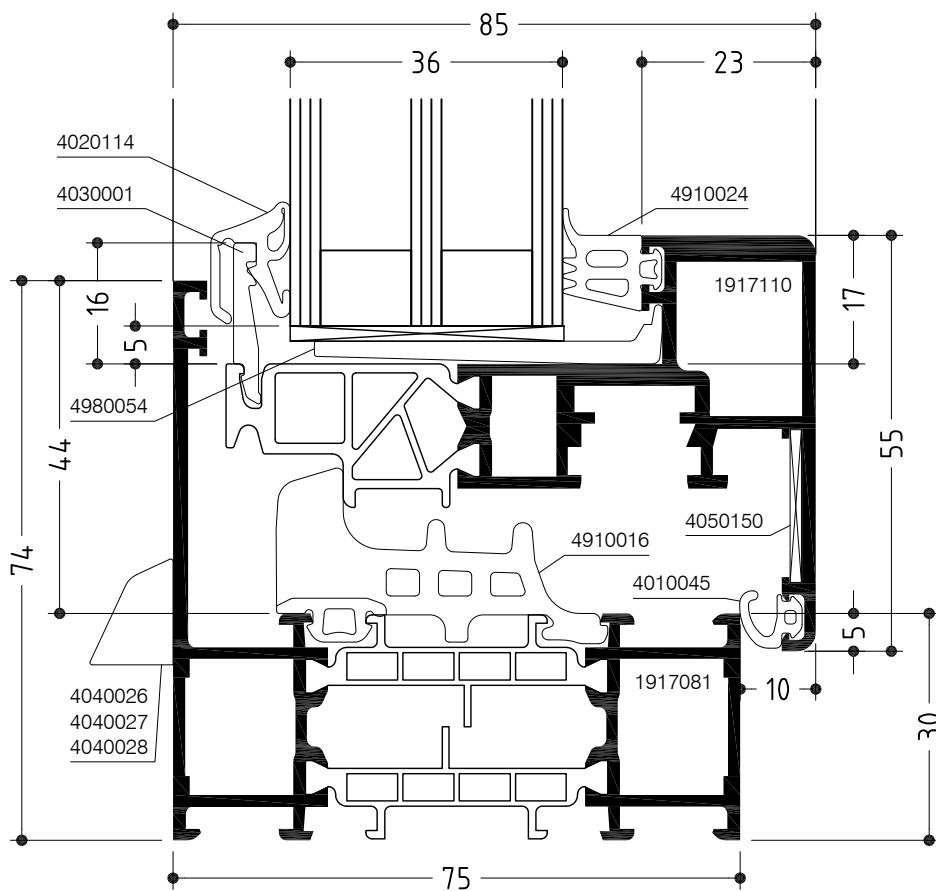

WICLINE 75

Flügelprofil im Blendrahmen, verdeckter Flügel
Concealed sash in frame

Konstruktionsschnitt
Construction section

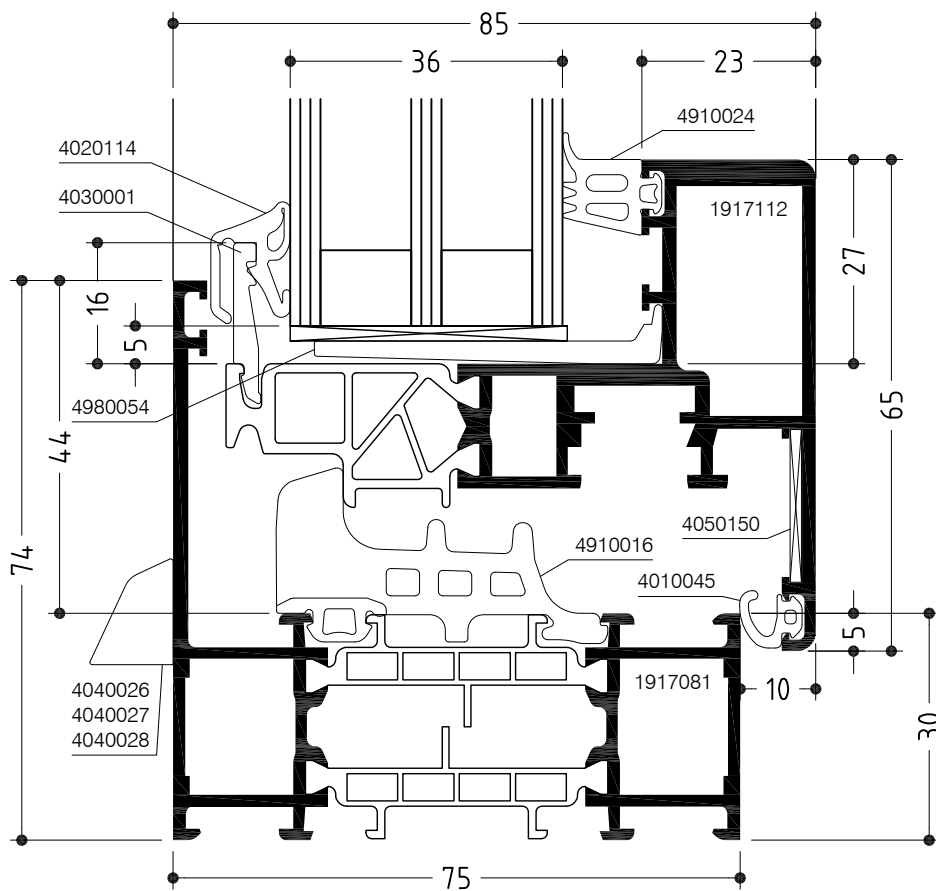

WICLINE 75

Stulpfenster - Mittelstoß, verdeckter Flügel
Double casement window with concealed sash - Meeting stiles

Konstruktionsschnitt
Construction section

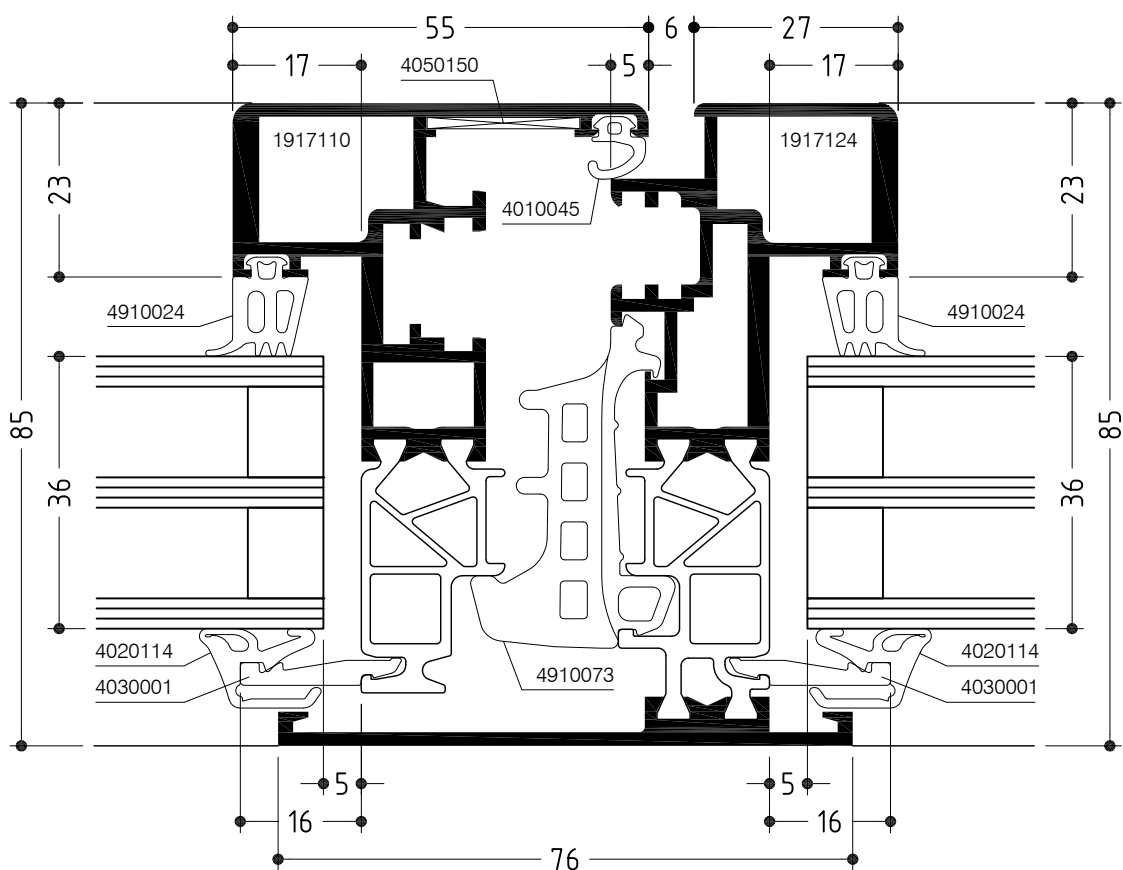
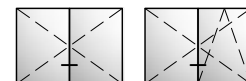

WICLINE 75

Flügelprofil im Blendrahmen mit Kämpfer, verdeckter Flügel
Concealed sash in frame with transom

Konstruktionsschnitt
Construction section

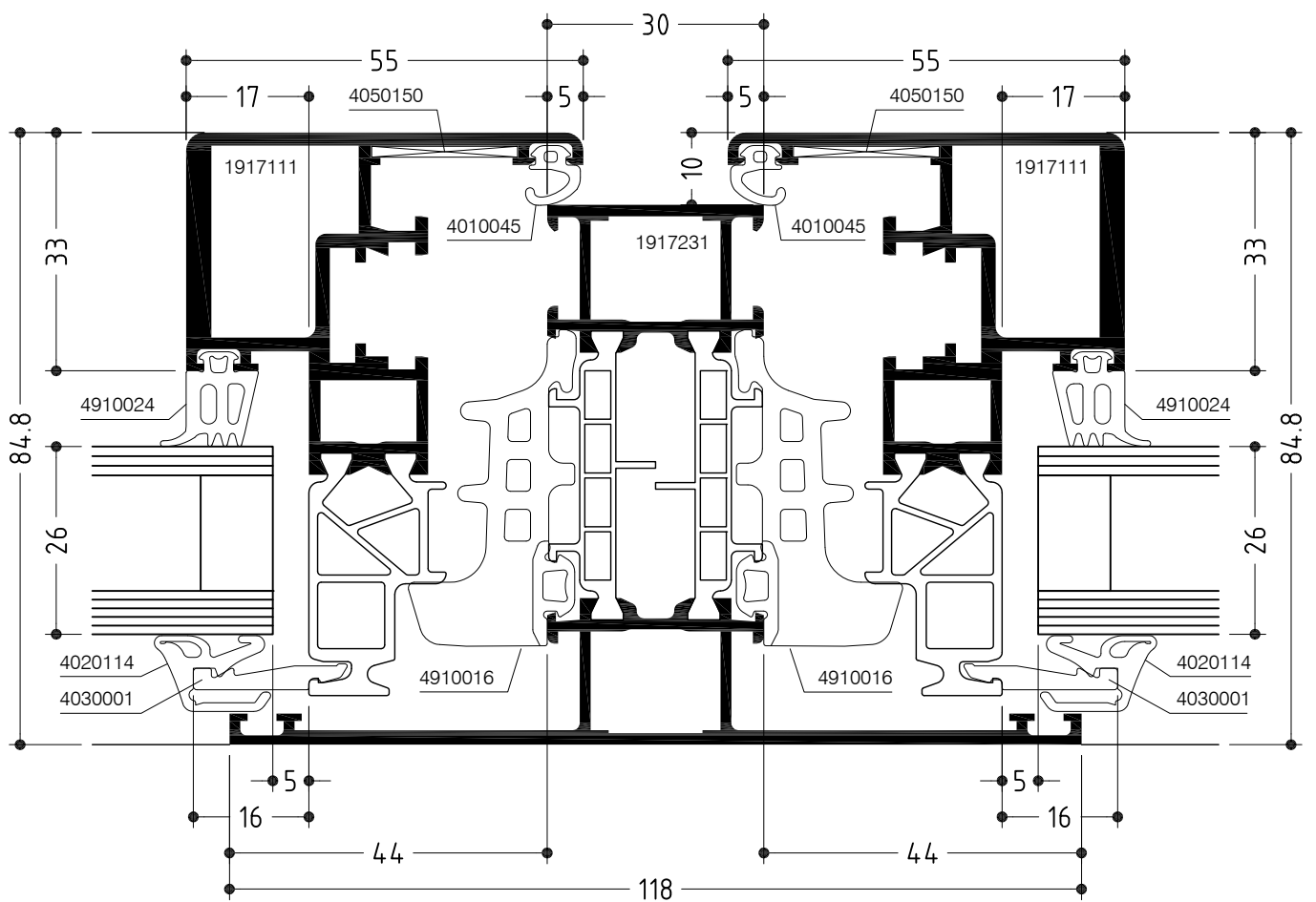
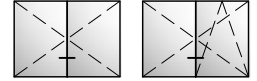

WICLINE 75

Flügelprofil im Einspannblendrahmen, verdeckter Flügel
Concealed sash in clamping frame

Konstruktionsschnitt
Construction section

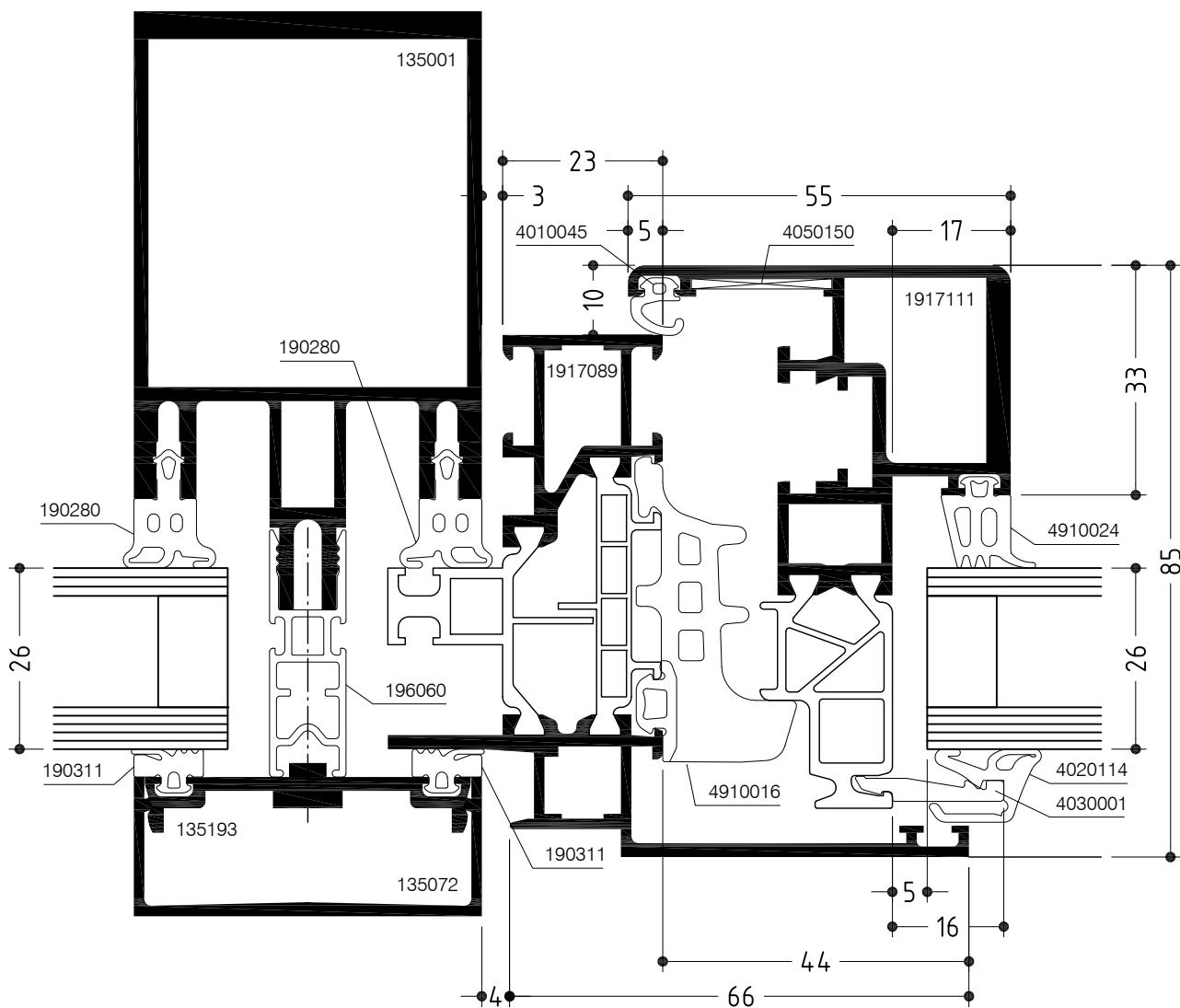
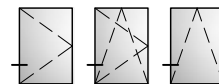

WICLINE 75

Flügelprofil im Blendrahmen mit Einspannaufsatz, verdeckter Flügel
Concealed sash in frame with supplementary clamping profile

Konstruktionsschnitt
Construction section

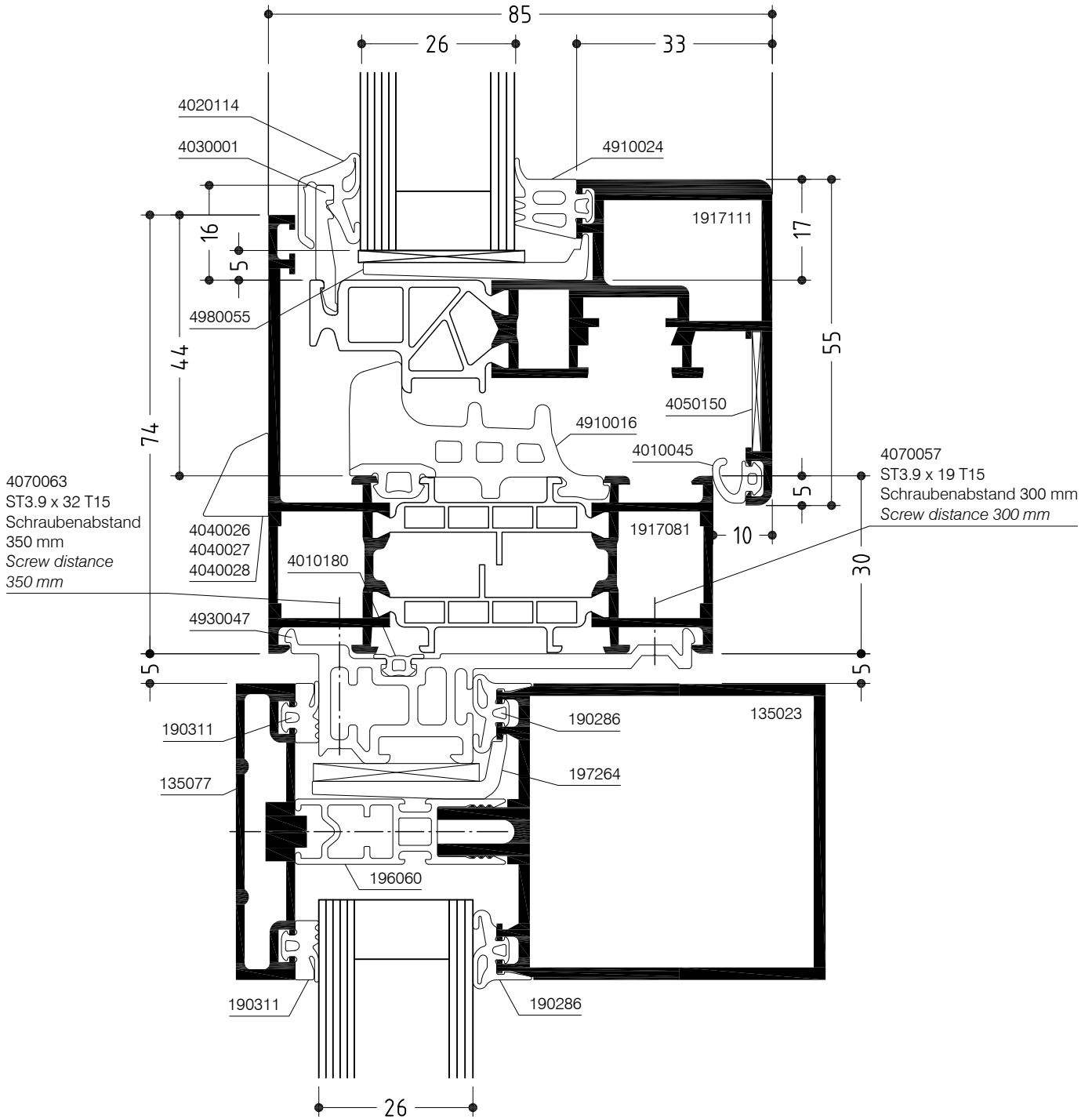

WICLINE 75

Zusatzprofil 160747 und 3091057
Additional profile 160747 and 3091057

Konstruktionsschnitt
Construction section

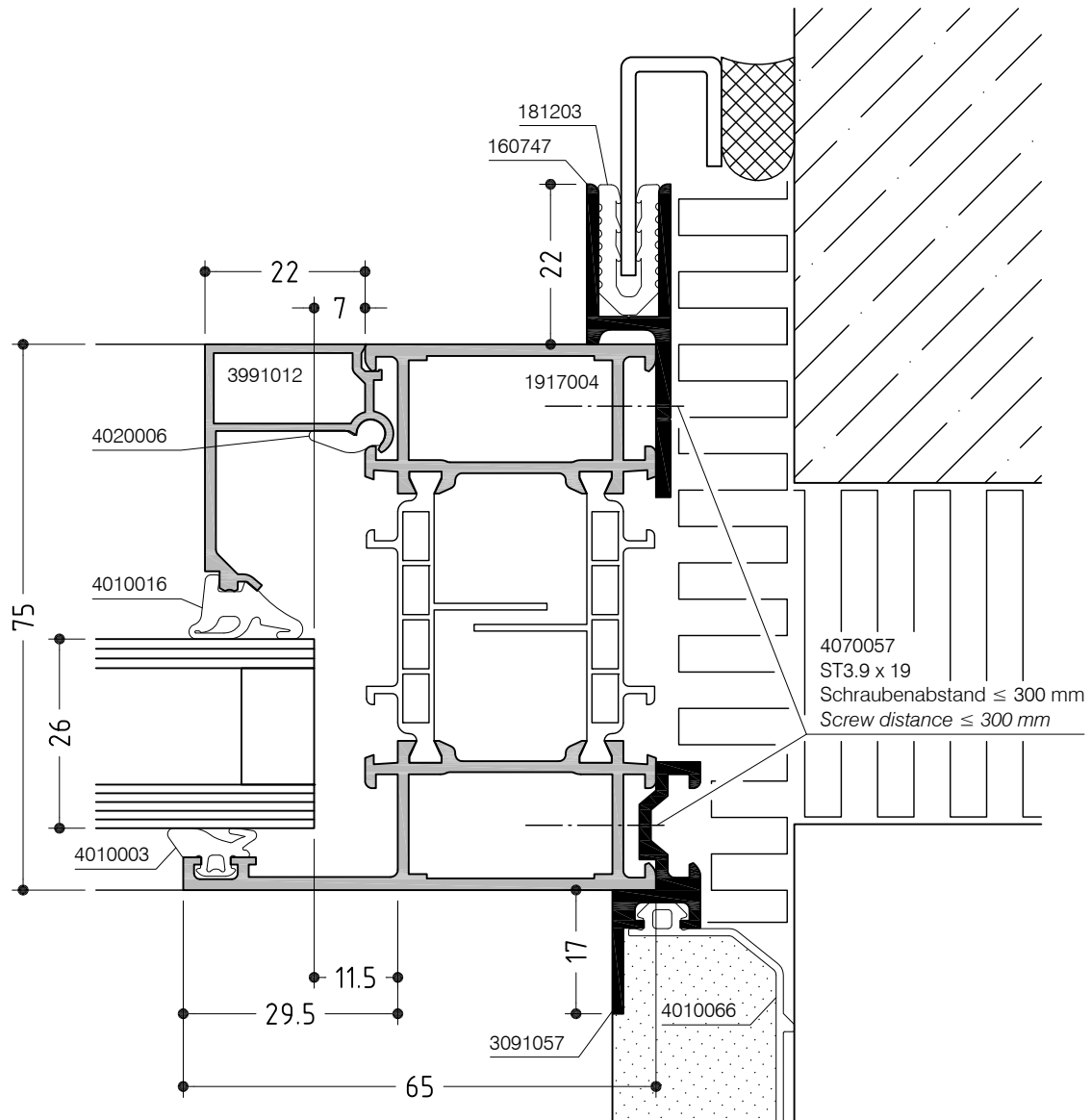

WICLINE 75

Zusatzprofil 3091055 und 3091057
Additional profile 3091055 and 3091057

Konstruktionsschnitt
Construction section

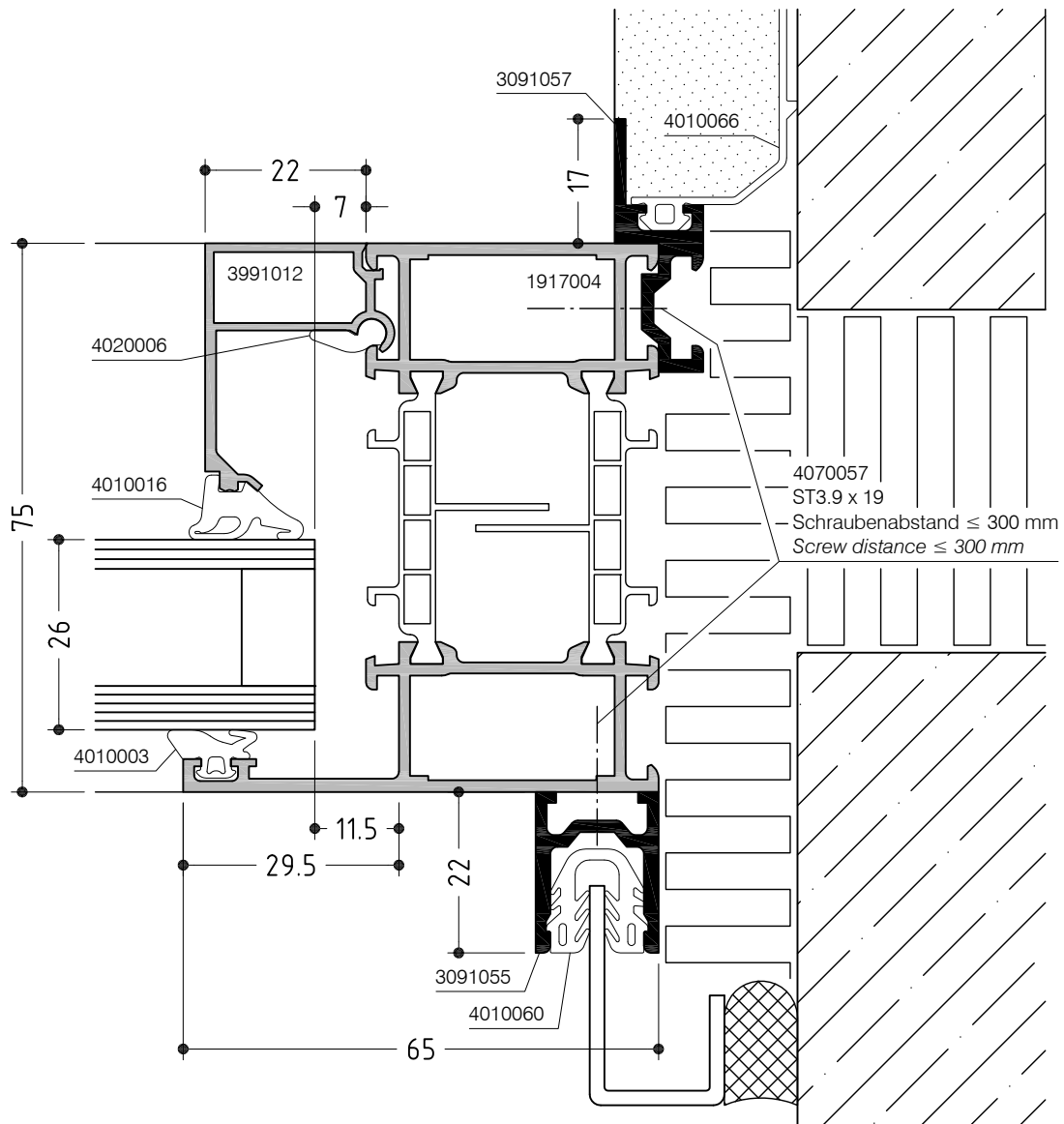

WICLINE 75

Zusatzprofil 3091045
Additional profile 3091045

Konstruktionsschnitt
Construction section



4070040
ST3.9 x 13 T15
Schraubenabstand \leq 250 mm
Screw distance \leq 250 mm

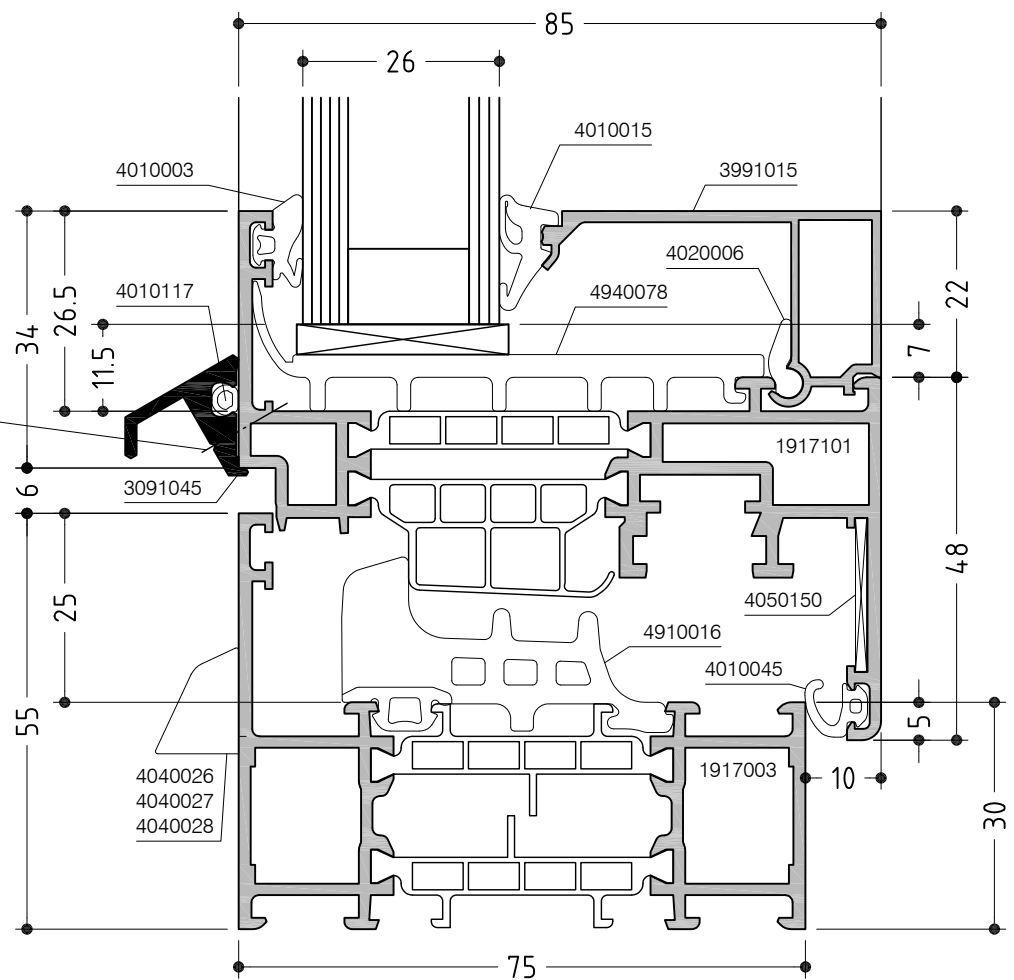

WICLINE 75

Zusatzprofil 3091039 und 3091040
Additional profile 3091039 and 3091040

Konstruktionsschnitt
Construction section

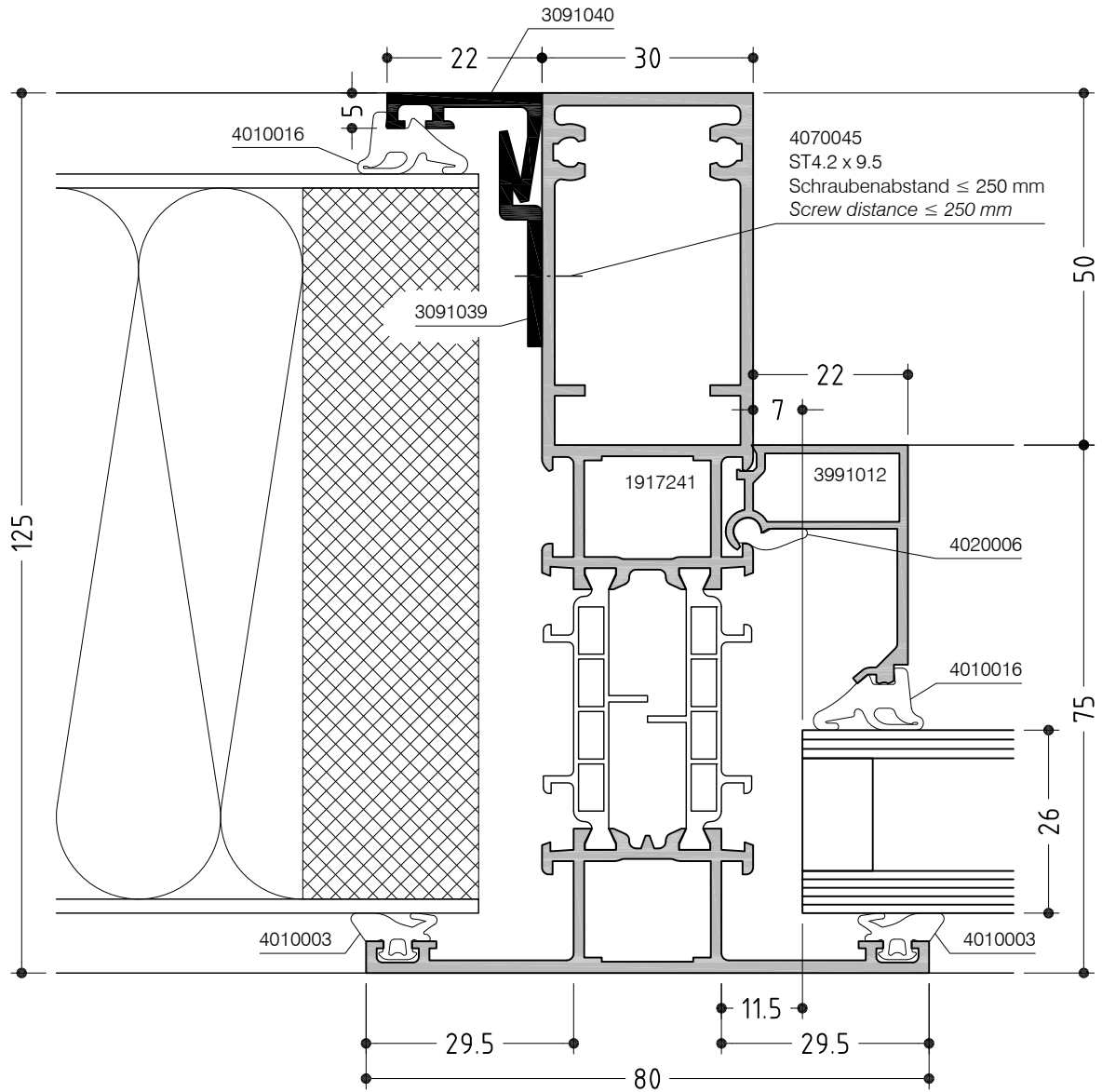
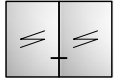

WICLINE 75

Zusatzprofil 3091049 und 3091050
Additional profile 3091049 and 3091050

Konstruktionsschnitt
Construction section

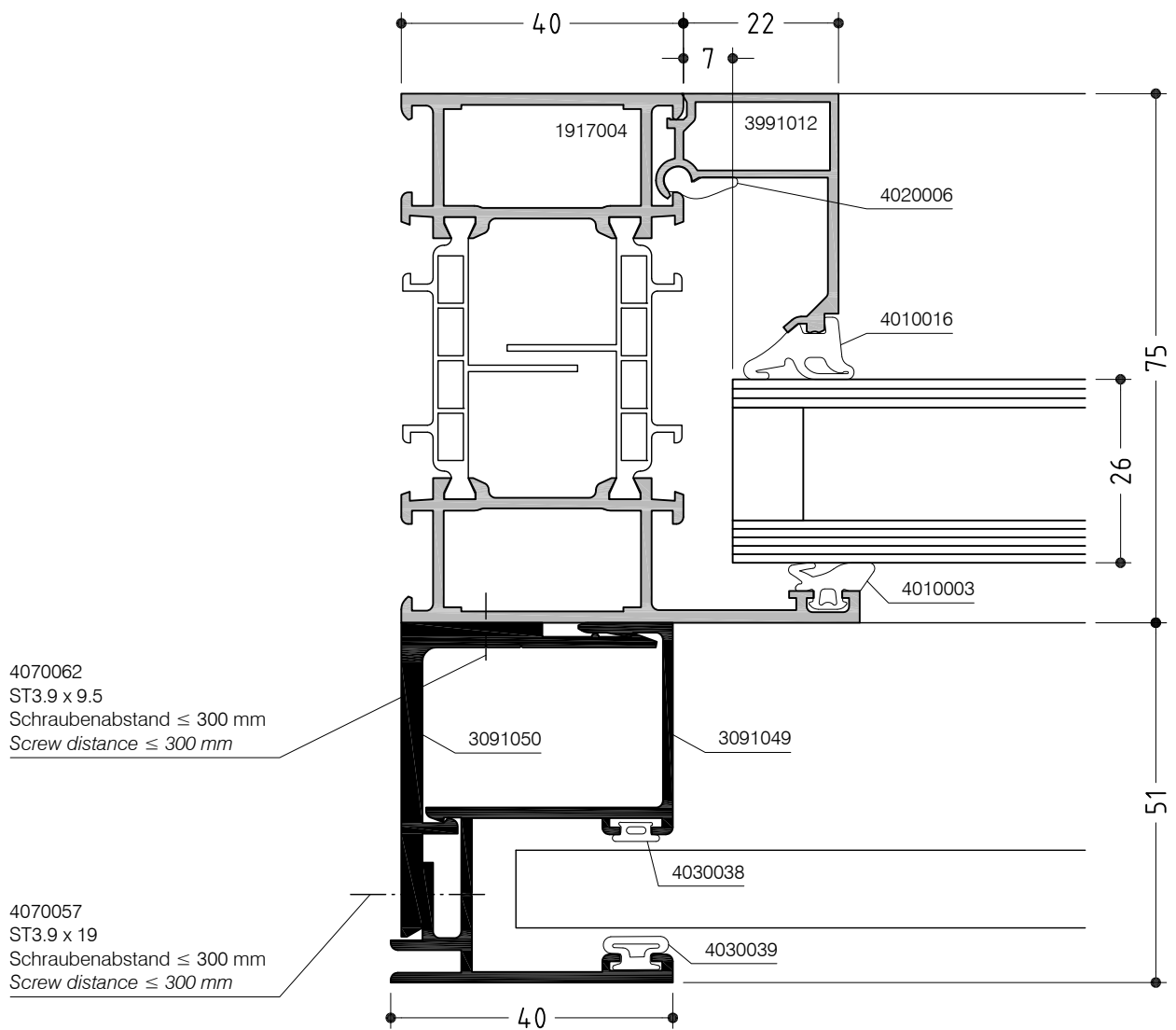

WICLINE 75

Zusatzprofil 3091037 und 3991280

Additional profile 3091037 and 3991280

Konstruktionsschnitt

Construction section

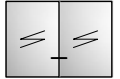

Schnitt 90° gedreht
Section turned by 90°

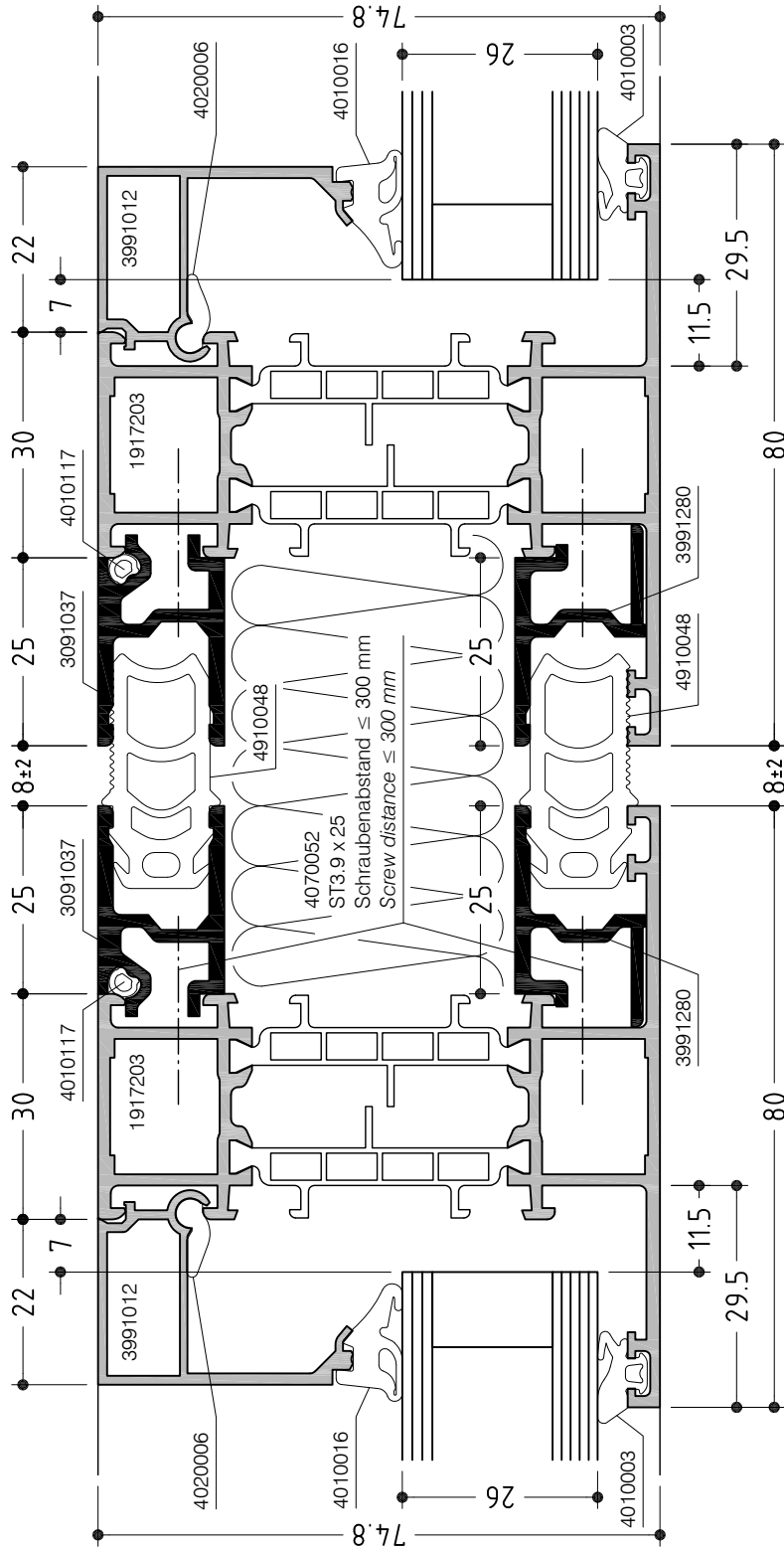

WICLINE 75

Konstruktionsschnitt Construction section

Zusatzprofil 3091044 und 3091054
Verstärkungsprofile Fenstertüren
Additional profiles 3091044 and 3091054
Reinforcement profile casement doors

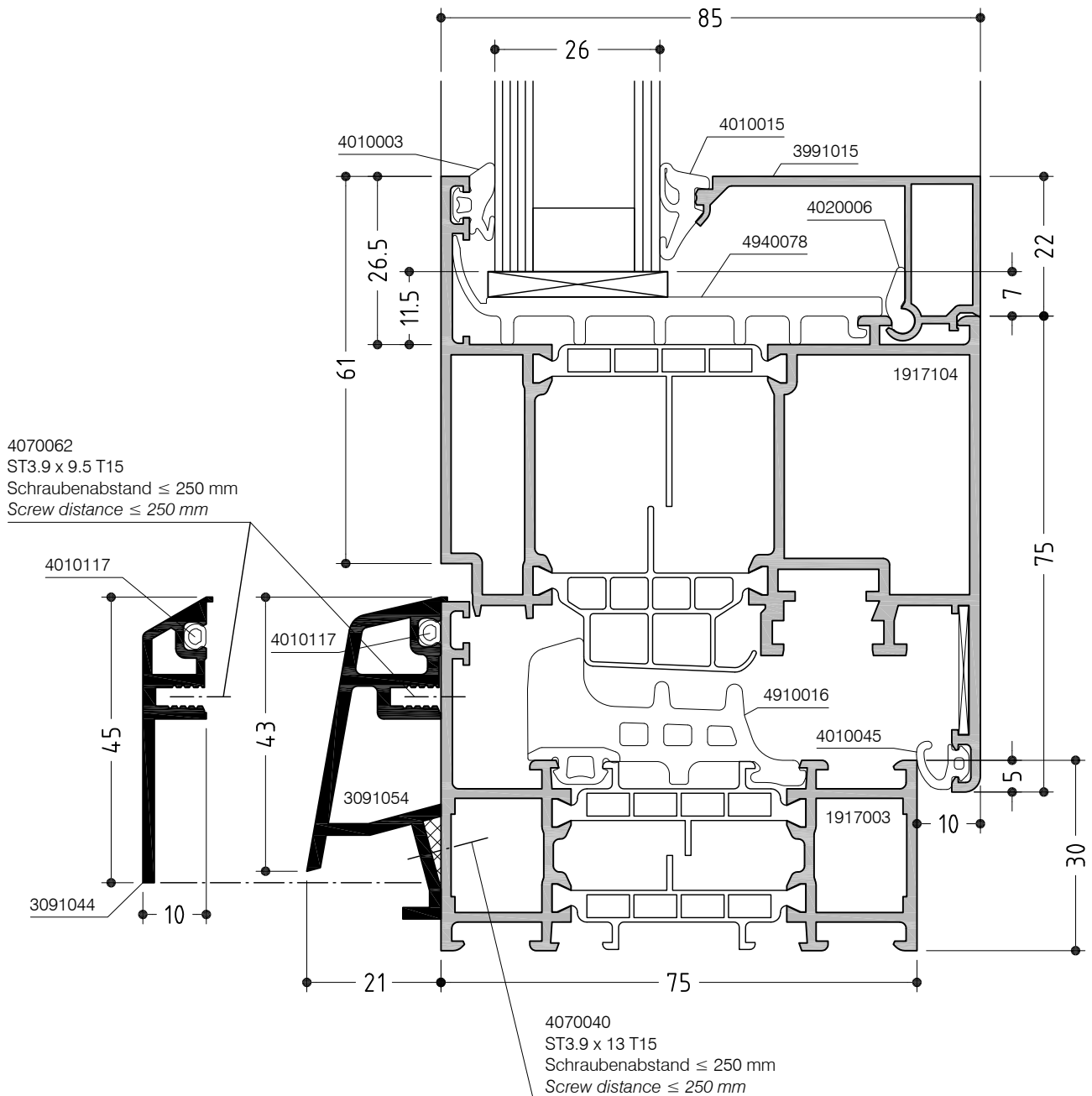

WICLINE 75

Konstruktionsschnitt Construction section

Zusatzprofil 3091036, 3991215, 3991216 und 3991217
Additional profile 3091036, 3991215, 3991216 and 3991217

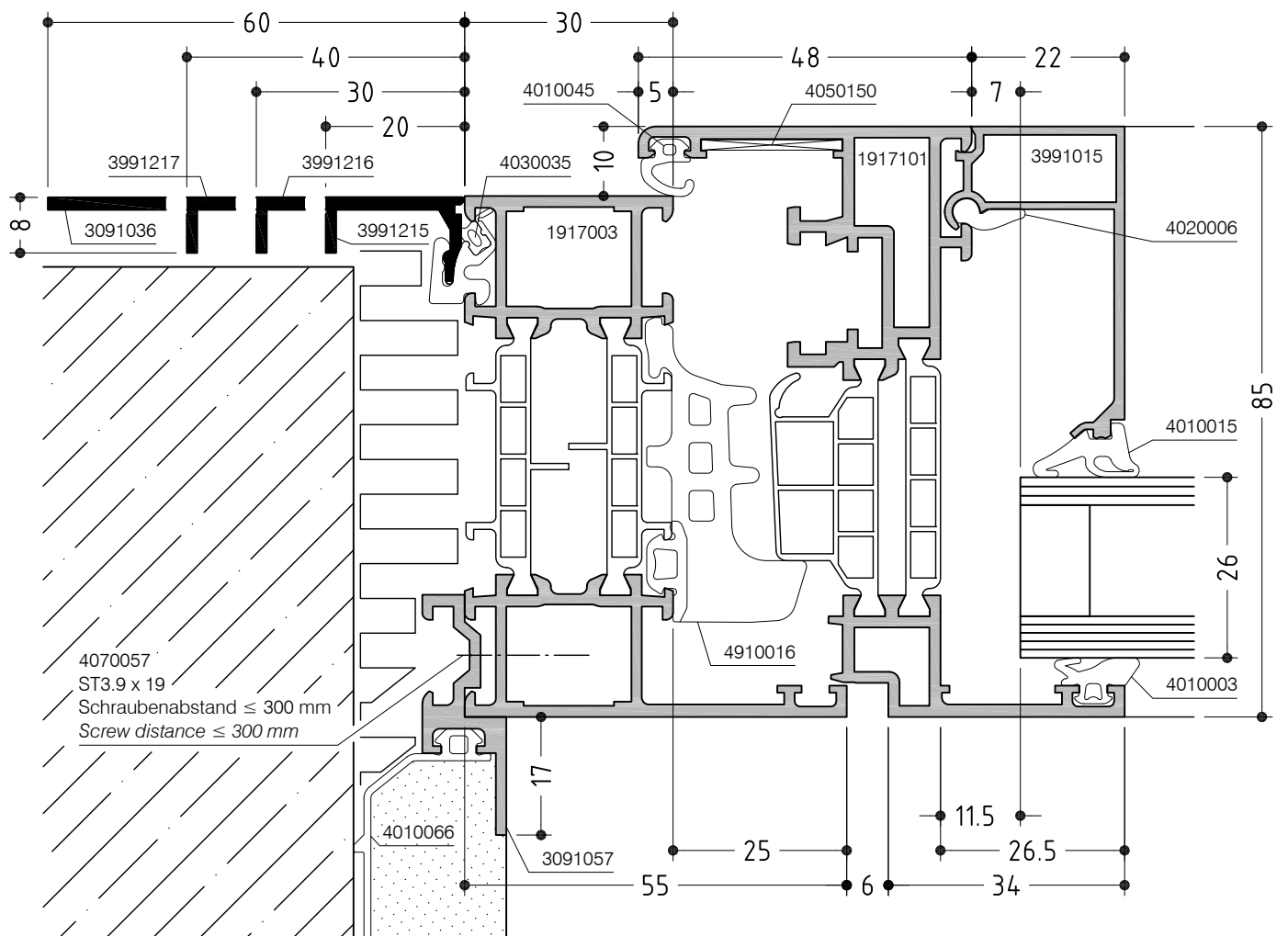

WICLINE 75

Zusatzprofil 3091031 und 3991234
Additional profile 3091031 and 3991234

Konstruktionsschnitt
Construction section

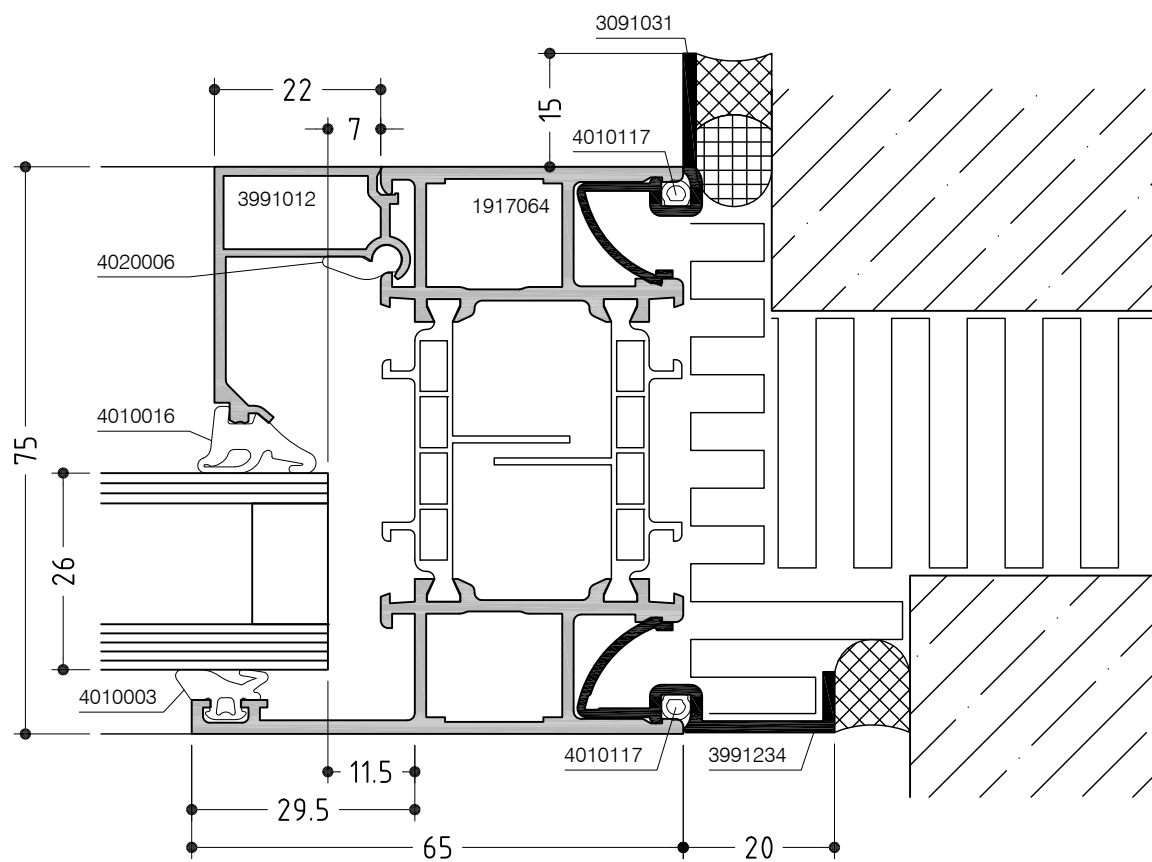

WICLINE 75

Zusatzprofil 3991237
Additional profile 3991237

Konstruktionsschnitt
Construction section

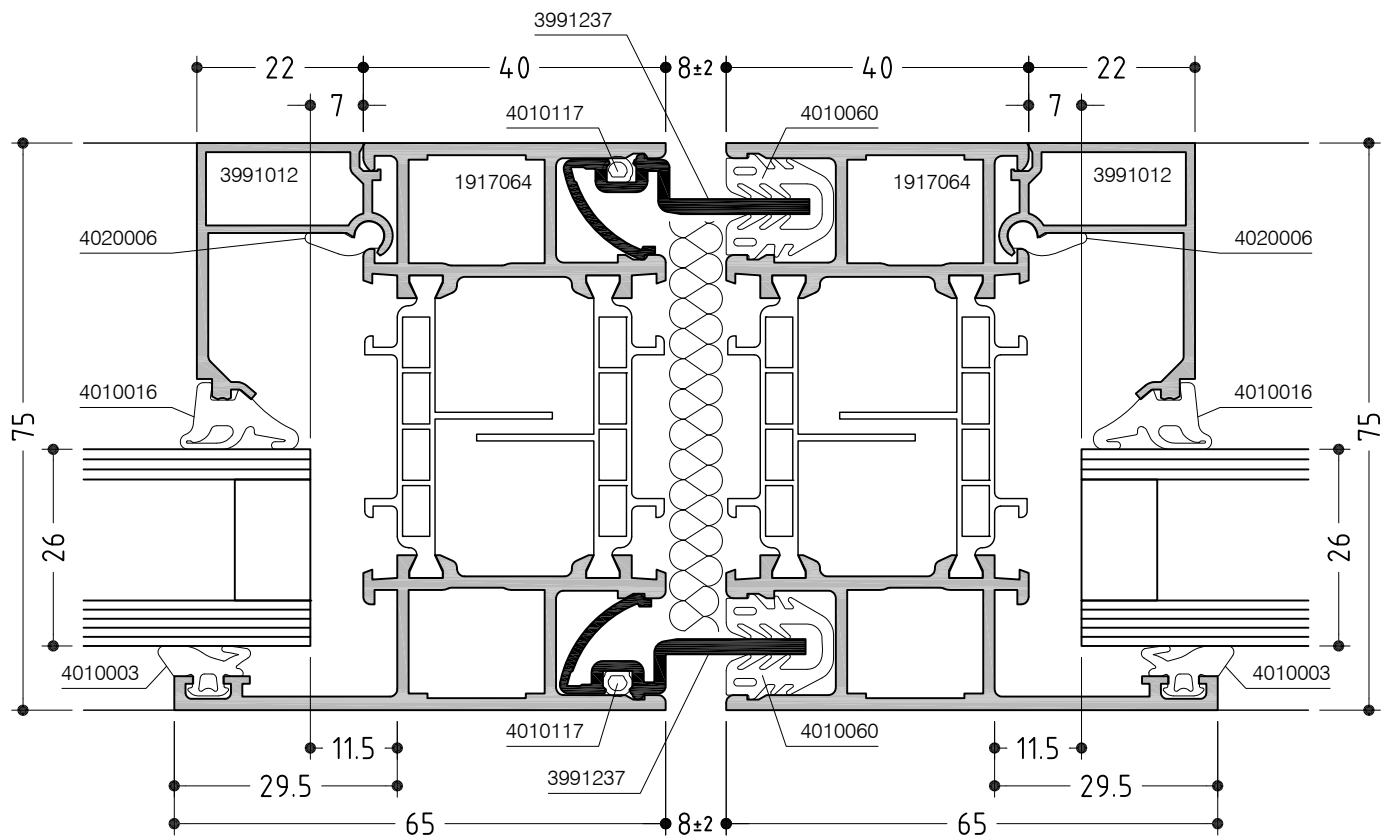
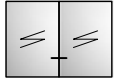



Bauanschlüsse

Junction to structure



WICLINE 75

Bauanschluss unten - Maßstab 1:2

Bottom junction - Scale 1:2

Bauanschlüsse
Junction to structure



Hinweise zum Konstruktionsvorschlag:

- Es gelten die Verarbeitungsrichtlinien der Wicona-Programme
- Die Dimensionierung der Profile, Verarbeitungsmittel, Verankerungen, Dübel, Schrauben und Verglasungen müssen der statischen Berechnung den gültigen Normen und Vorschriften entsprechen und werden eigenverantwortlich durch die ausführende Firma festgelegt.
- Die dargestellten Bauanschlüsse sind bauphysikalisch zu überprüfen.
- Die fachgerechte Ausführung liegt im Verantwortungsbereich der ausführenden Firma.
- WICONA wird hierfür keine Gewähr übernehmen.

Comments to the Construction offer:

- Processing guidelines, according to the Wicona workshop manuals
- The dimensioning of the profiles, processing means anchors, frame dowels, screws and glasses, has to be done according to the valid standards, regulations and according to the statical calculations. This has to be done self-dependent by the construction company.
- The shown junction to the structure, has to be checked concerning the construction physics.
- The professional workmanship, is in the area of responsibility of the manufacturer.
- Wicona will not give any warranty on this.

WICLINE 75

Bauanschluss unten - Maßstab 1:2

Bottom junction - Scale 1:2

Bauanschlüsse
Junction to structure

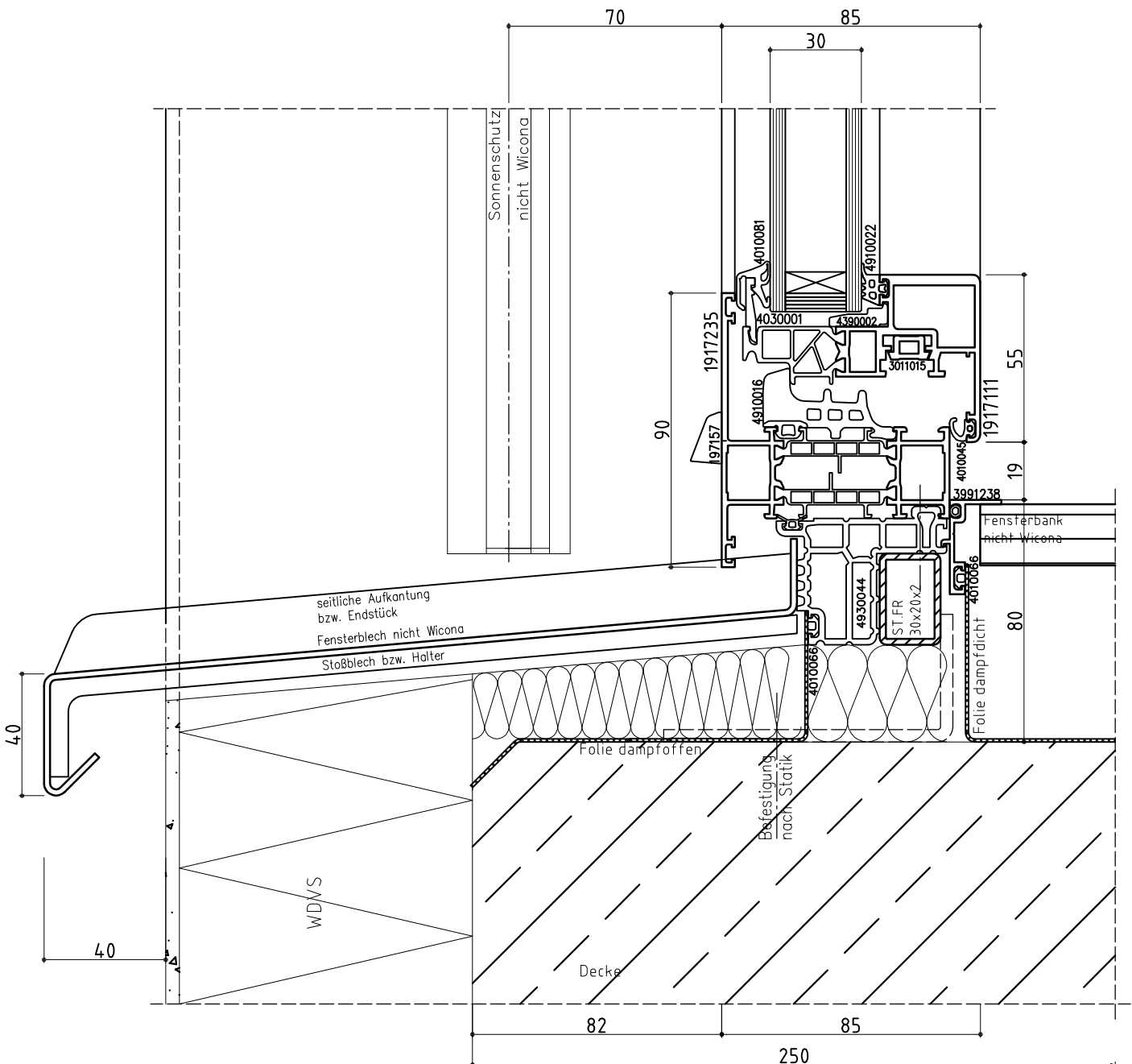

Der dargestellte Bauanschluss ist bauphysikalisch zu überprüfen.
The shown junction to the structure, has to be checked concerning the construction physics.

WICLINE 75

Bauanschluss unten - Maßstab 1:2

Bottom junction - Scale 1:2

Bauanschlüsse
Junction to structure

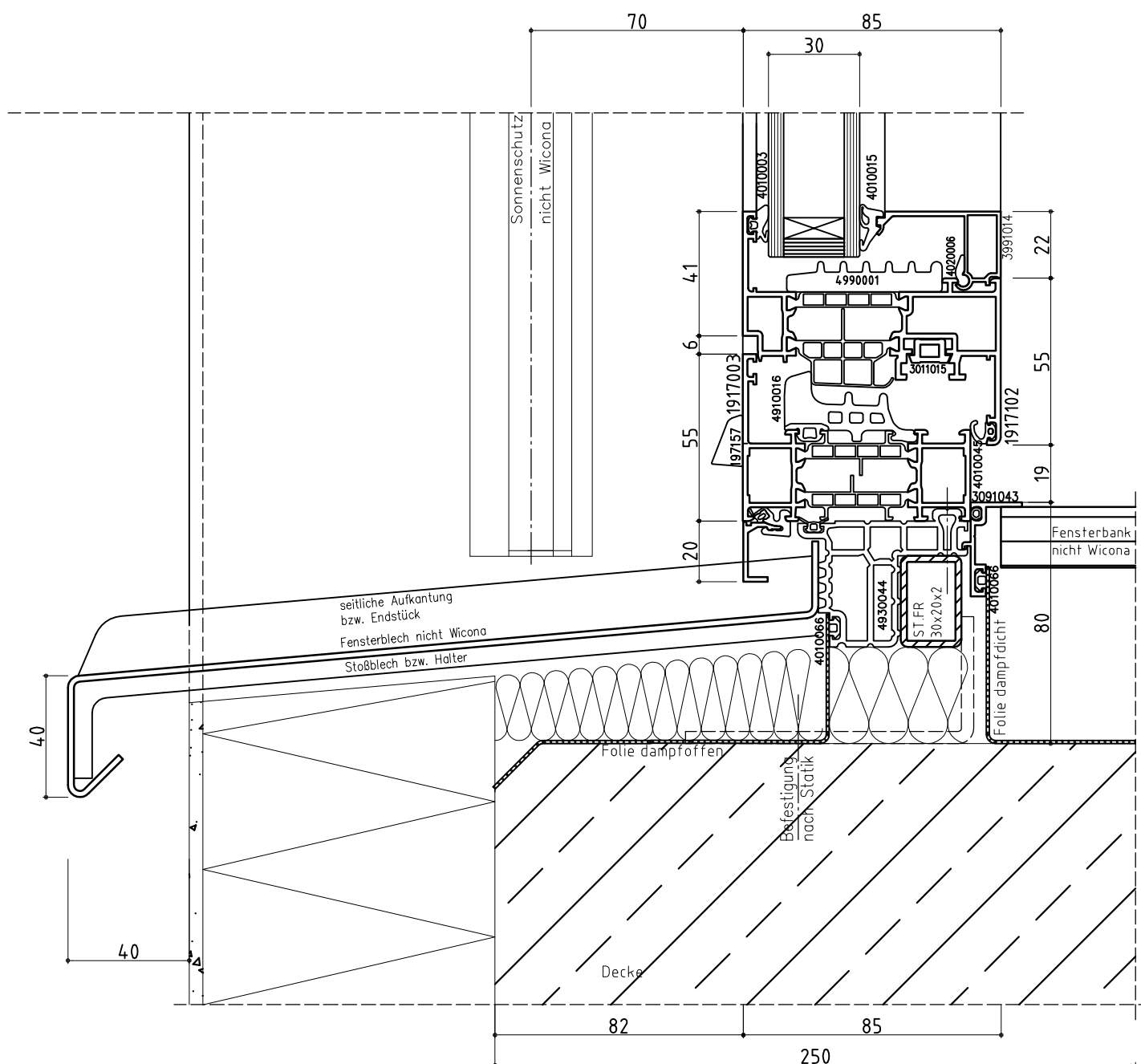
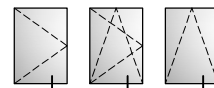

Der dargestellte Bauanschluss ist bauphysikalisch zu überprüfen.
The shown junction to the structure, has to be checked concerning the construction physics.

WICLINE 75

Bauanschluss unten - Maßstab 1:2

Bottom junction - Scale 1:2

Bauanschlüsse
Junction to structure

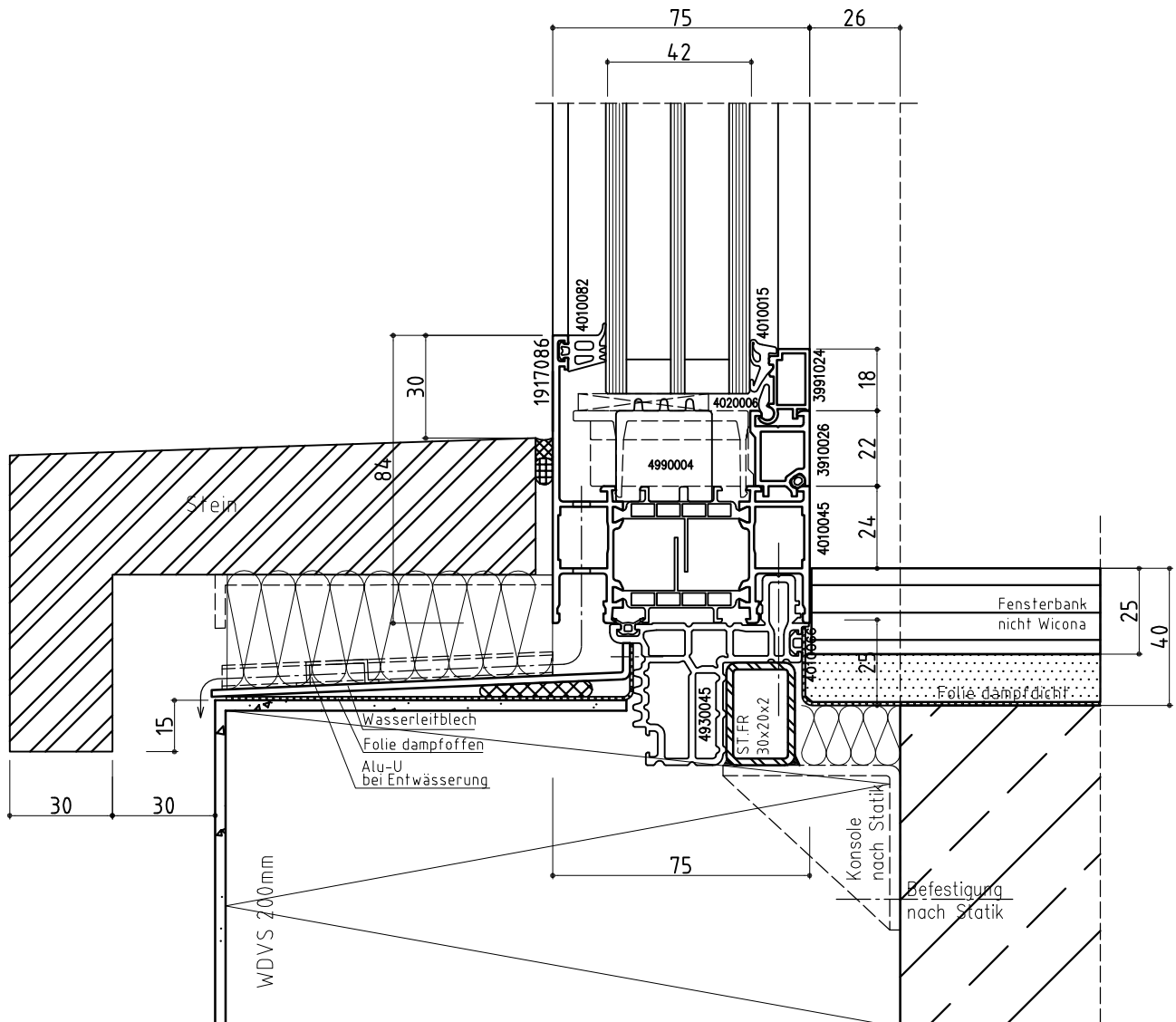

Der dargestellte Bauanschluss ist bauphysikalisch zu überprüfen.
The shown junction to the structure, has to be checked concerning the construction physics.

WICLINE 75

Bauanschluss unten - Maßstab 1:2

Bottom junction - Scale 1:2

Bauanschlüsse
Junction to structure

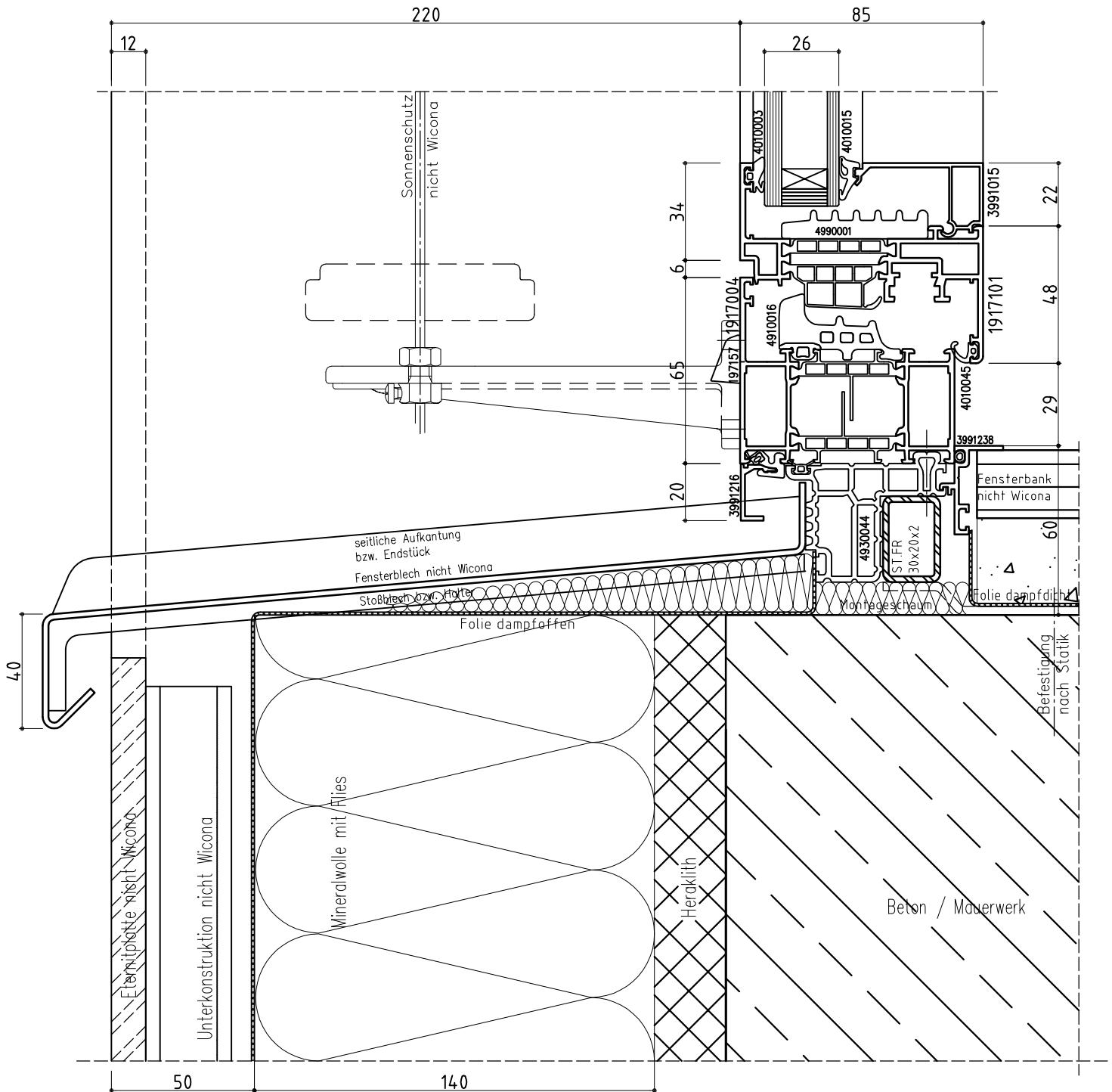

Der dargestellte Bauanschluss ist bauphysikalisch zu überprüfen.
The shown junction to the structure, has to be checked concerning the construction physics.

WICLINE 75

Bauanschluss unten - Maßstab 1:2

Bottom junction - Scale 1:2

Bauanschlüsse
Junction to structure

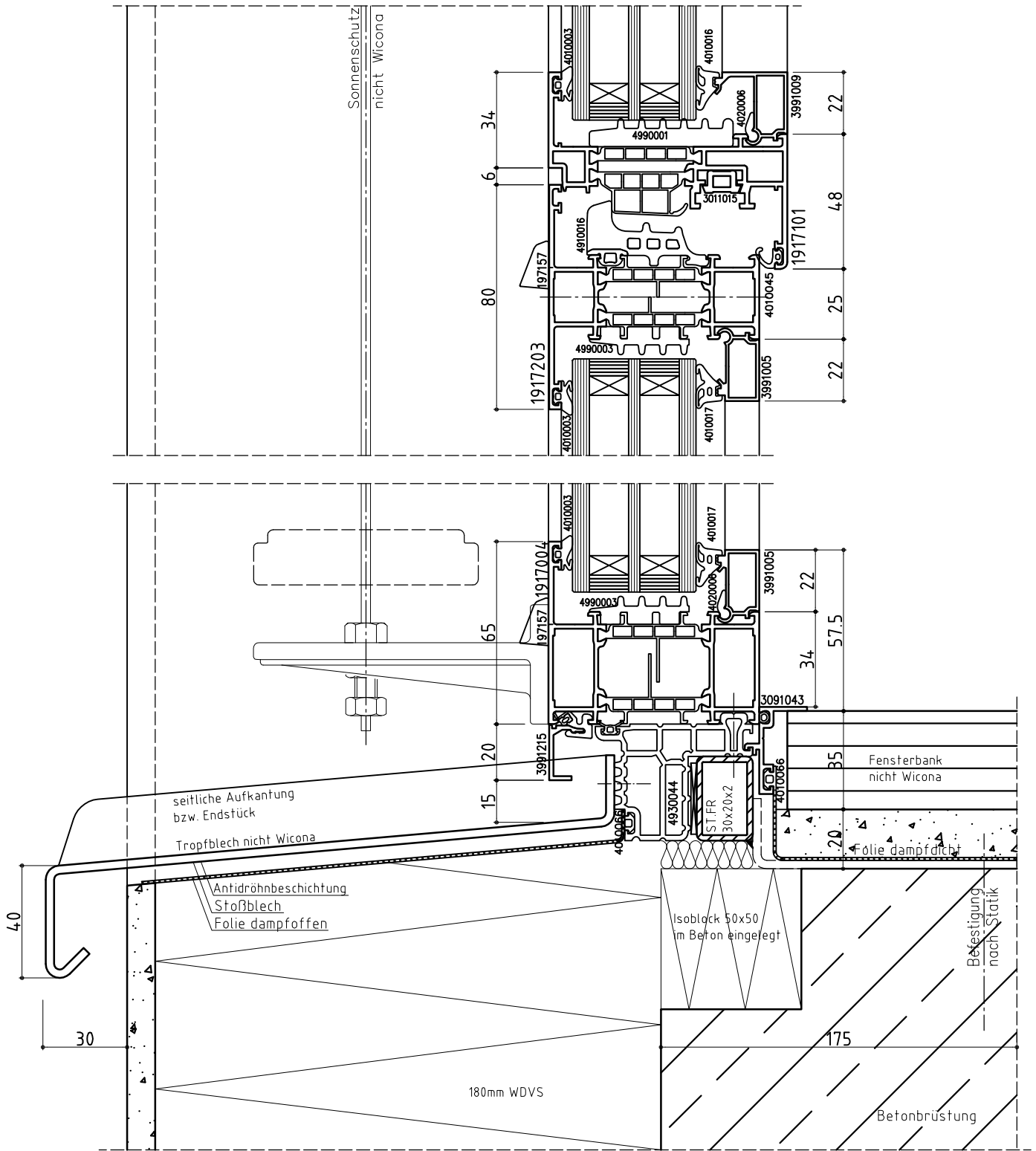

Der dargestellte Bauanschluss ist bauphysikalisch zu überprüfen.

The shown junction to the structure, has to be checked concerning the construction physics.

WICONA®

WICLINE 75

Bauanschluss unten - Maßstab 1:2

Bottom junction - Scale 1:2

Bauanschlüsse
Junction to structure

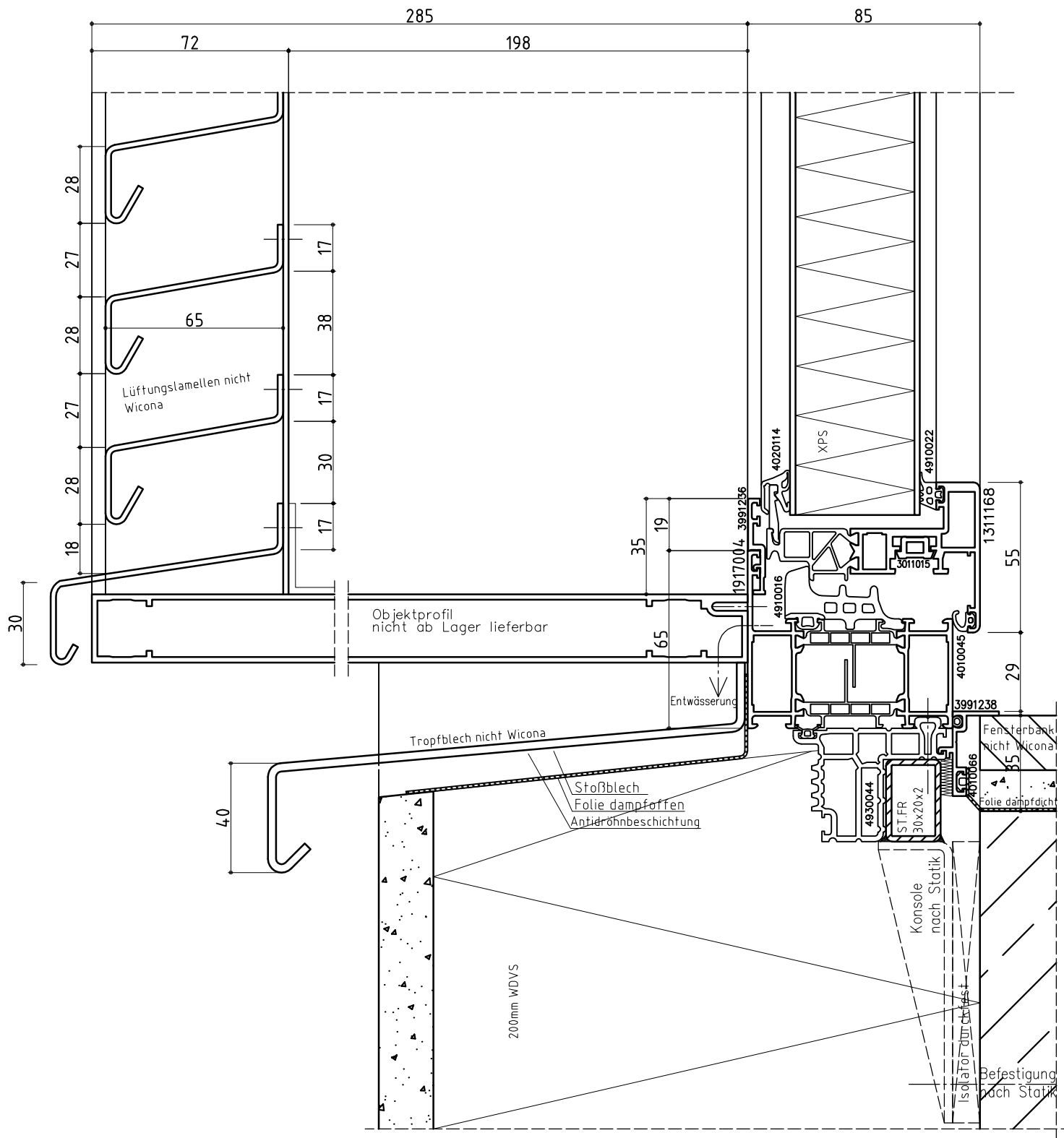
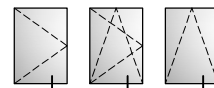

Der dargestellte Bauanschluss ist bauphysikalisch zu überprüfen.
The shown junction to the structure, has to be checked concerning the construction physics.

WICONA®

WICLINE 75

Bauanschluss unten - Maßstab 1:2

Bottom junction - Scale 1:2

Bauanschlüsse
Junction to structure

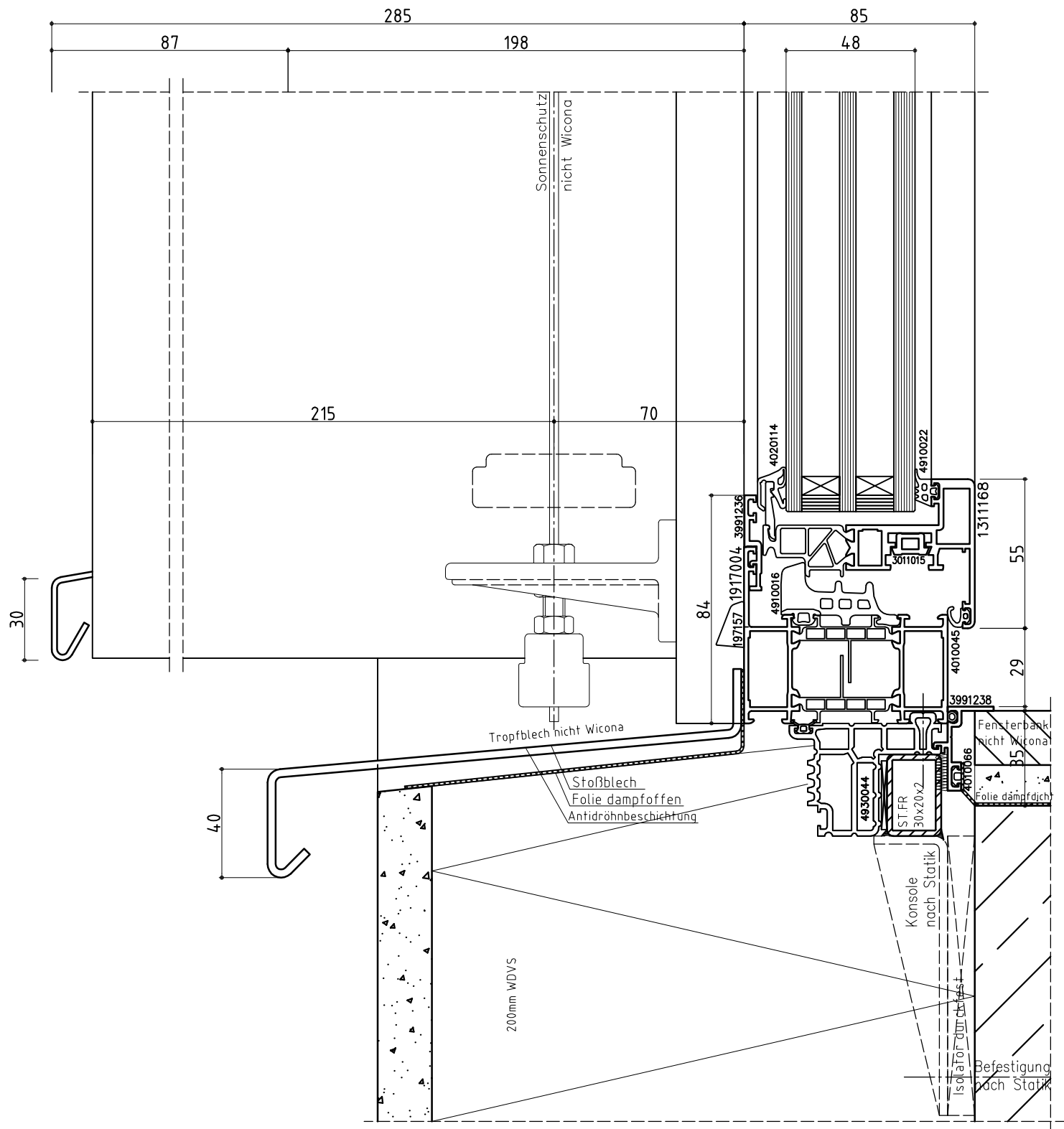
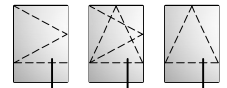

Der dargestellte Bauanschluss ist bauphysikalisch zu überprüfen.
The shown junction to the structure, has to be checked concerning the construction physics.

WICONA®

WICLINE 75

Bauanschlüsse Junction to structure

Bauanschluss unten - Maßstab 1:2

Bottom junction - Scale 1:2

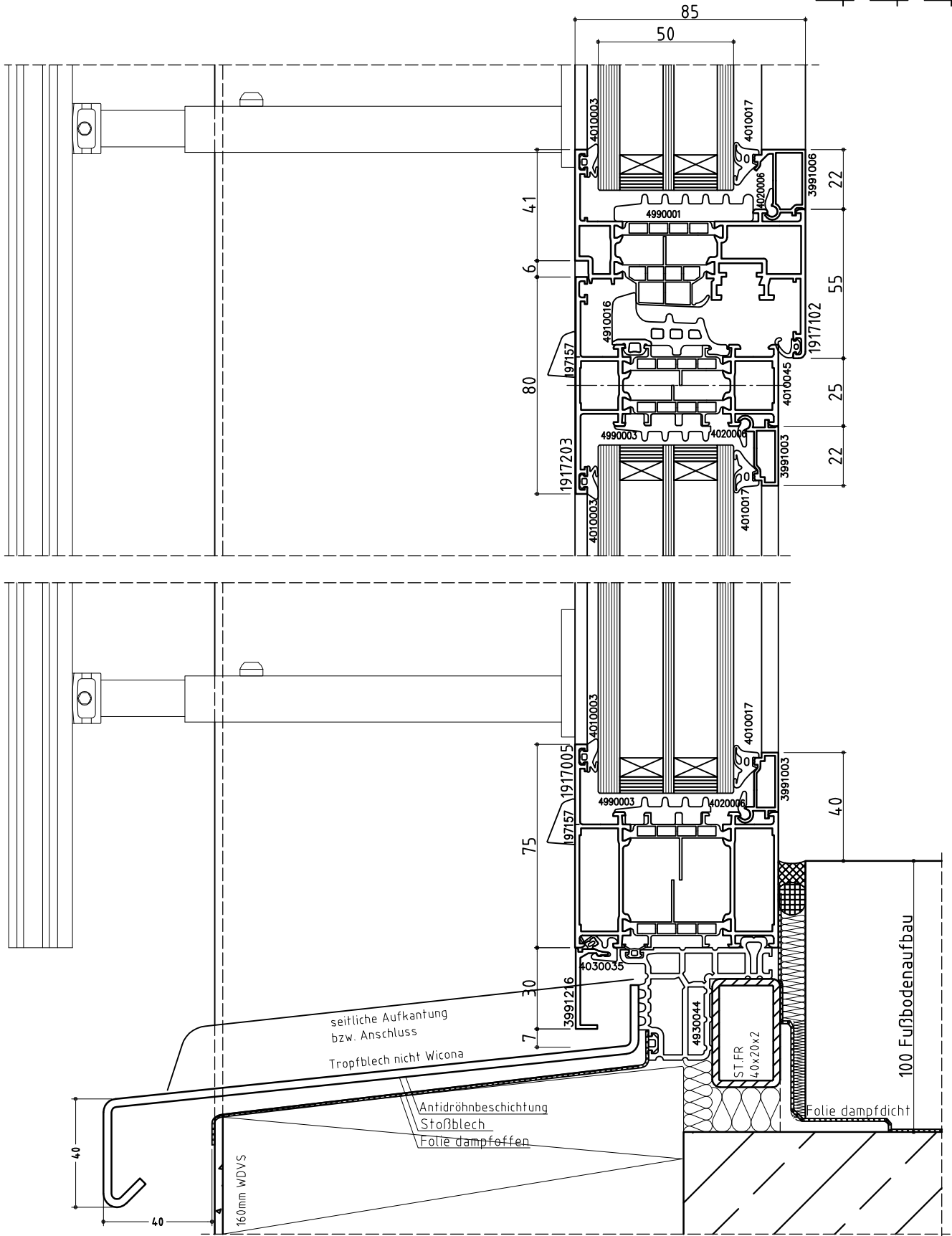

Der dargestellte Bauanschluss ist bauphysikalisch zu überprüfen.
The shown junction to the structure, has to be checked concerning the construction physics.

WICLINE 75

Bauanschluss unten - Maßstab 1:2

Bottom junction - Scale 1:2

Bauanschlüsse
Junction to structure

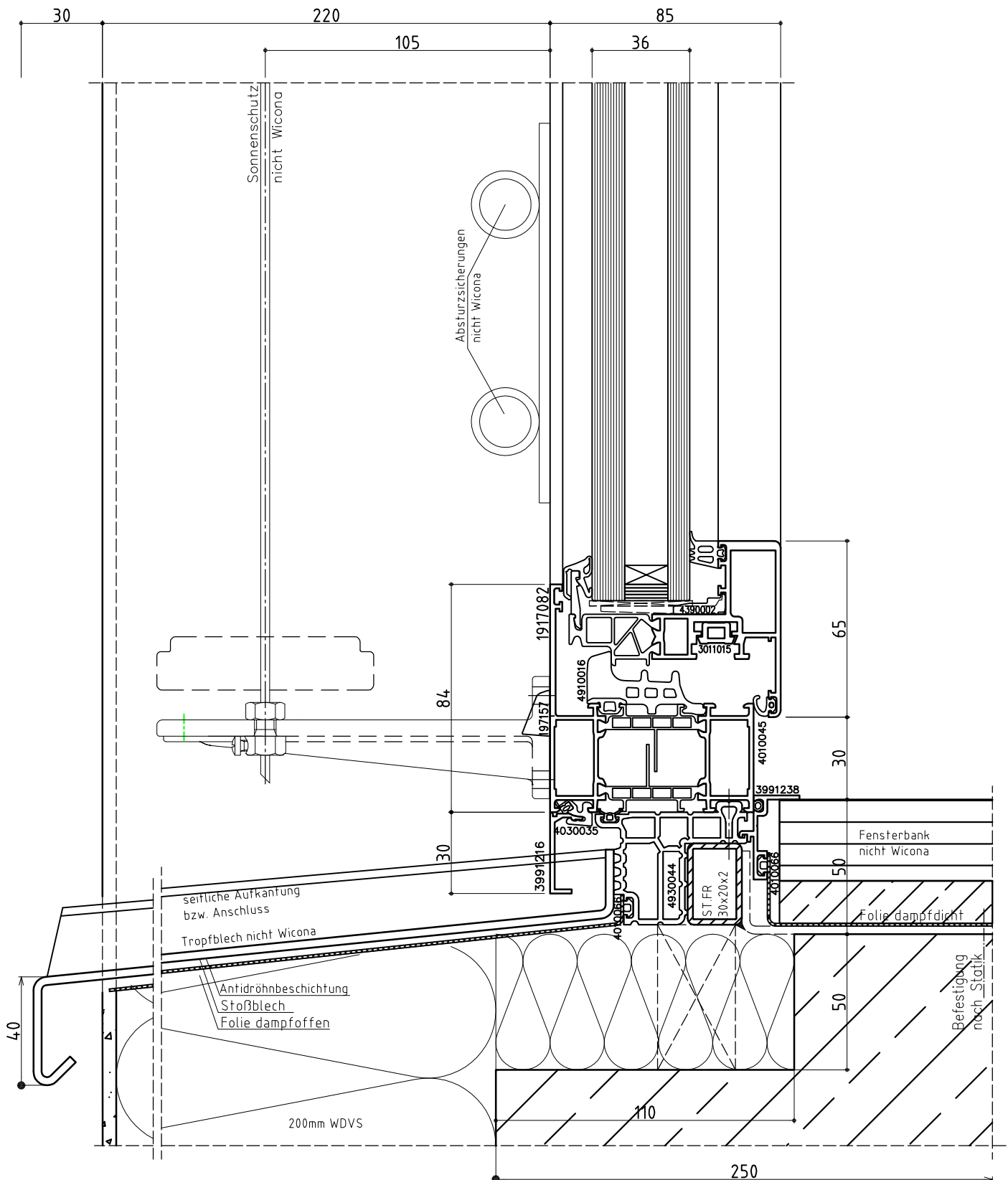

Der dargestellte Bauanschluss ist bauphysikalisch zu überprüfen.
The shown junction to the structure, has to be checked concerning the construction physics.

WICONA®

WICLINE 75

Bauanschluss unten - Maßstab 1:2

Bottom junction - Scale 1:2

Bauanschlüsse
Junction to structure

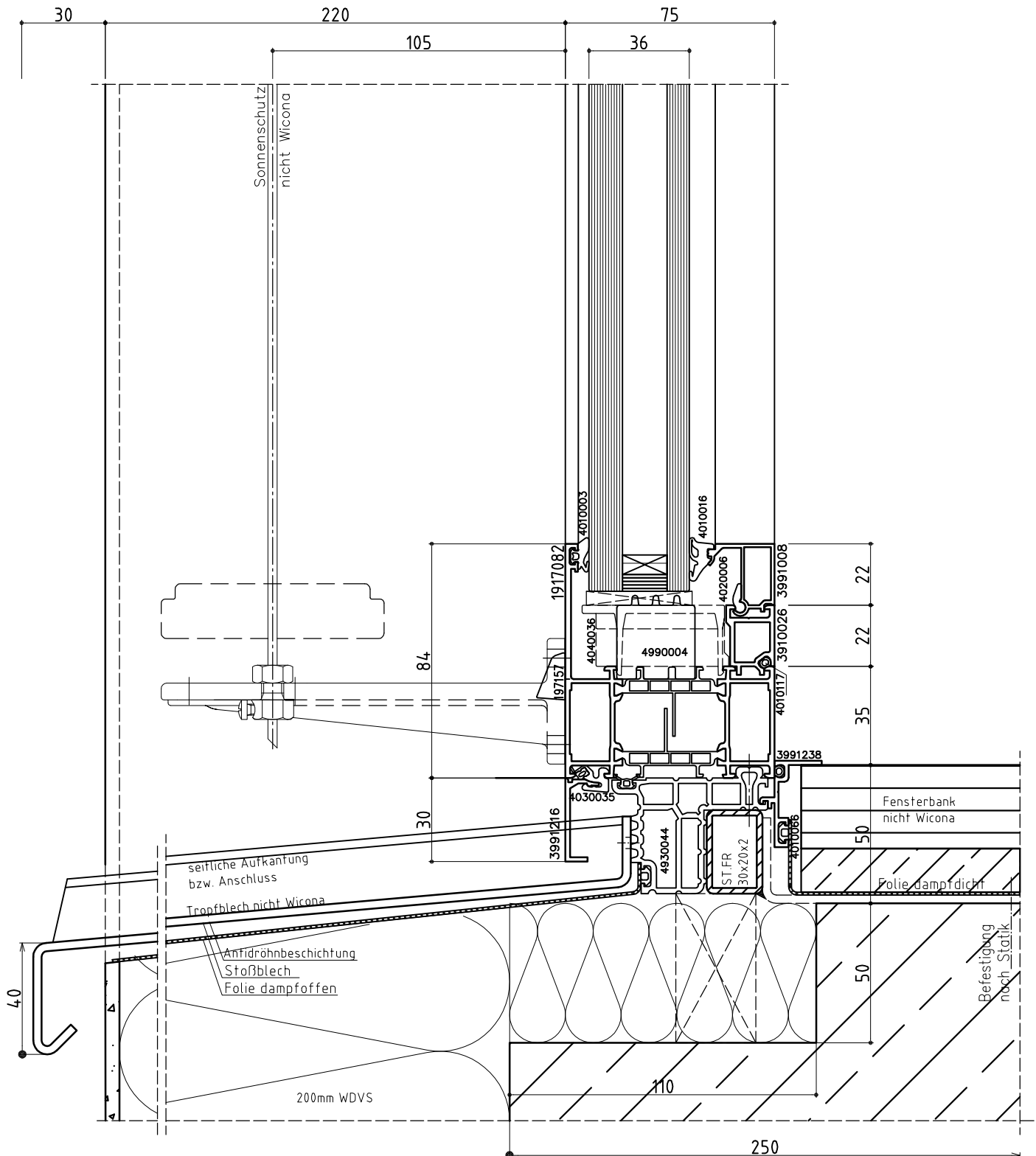

Der dargestellte Bauanschluss ist bauphysikalisch zu überprüfen.
The shown junction to the structure, has to be checked concerning the construction physics.

WICONA®

WICLINE 75

Bauanschluss unten - Maßstab 1:2

Bottom junction - Scale 1:2

Bauanschlüsse
Junction to structure

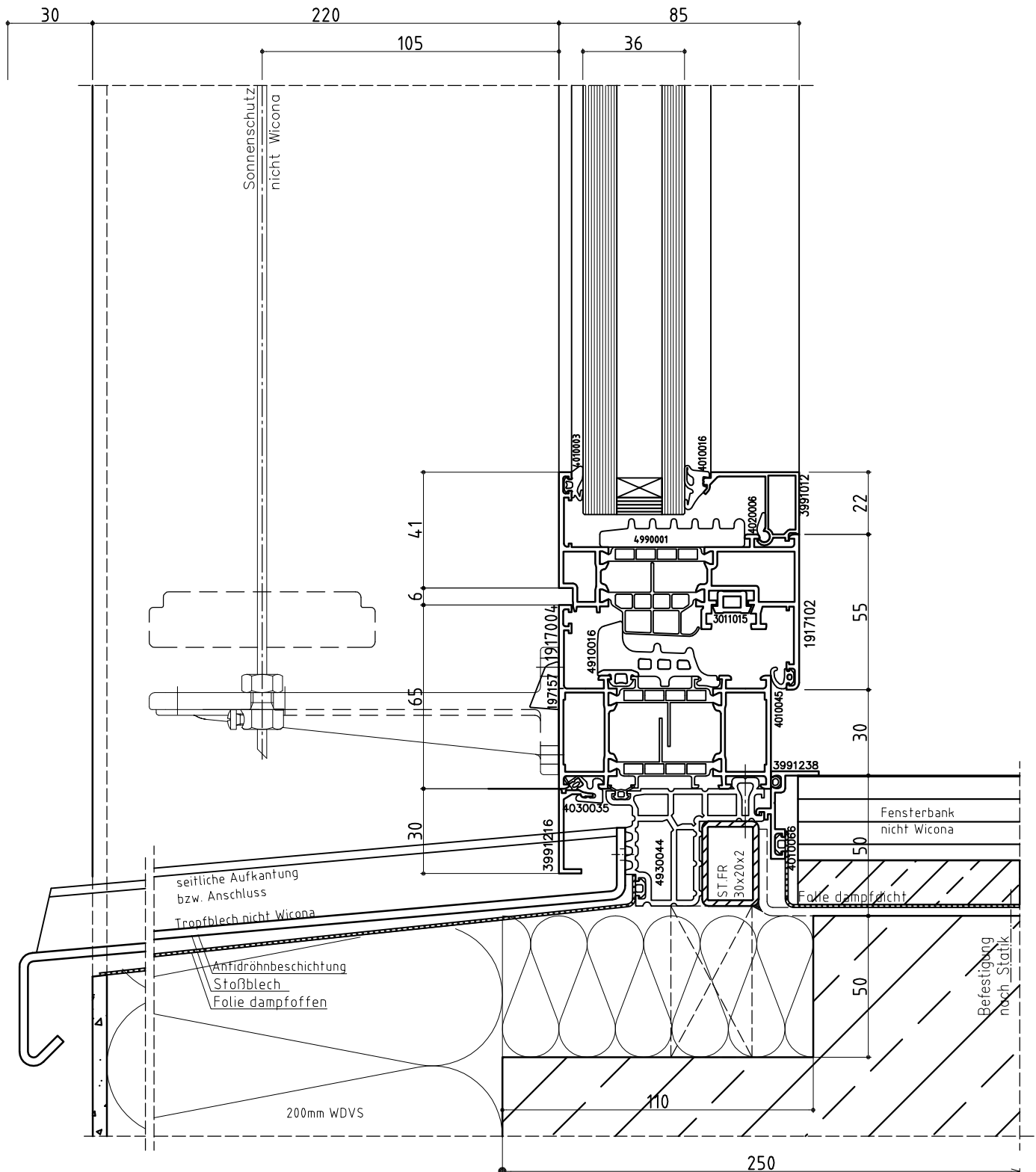

Der dargestellte Bauanschluss ist bauphysikalisch zu überprüfen.
The shown junction to the structure, has to be checked concerning the construction physics.

WICONA®

WICLINE 75

Bauanschluss unten - Maßstab 1:2

Bottom junction - Scale 1:2

Bauanschlüsse
Junction to structure

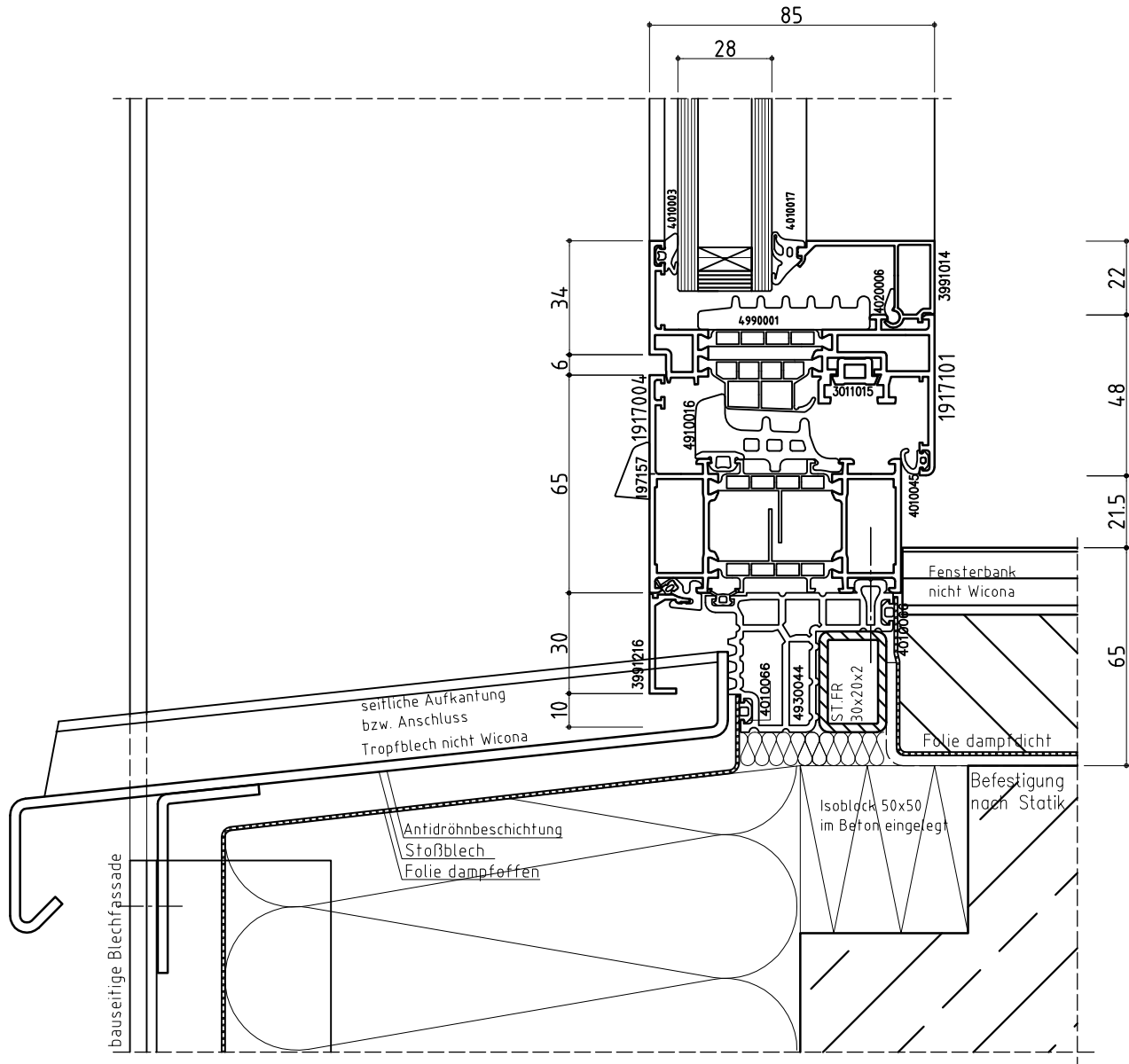

Der dargestellte Bauanschluss ist bauphysikalisch zu überprüfen.
The shown junction to the structure, has to be checked concerning the construction physics.

WICONA®

WICLINE 75

Bauanschluss unten - Maßstab 1:2

Bottom junction - Scale 1:2

Bauanschlüsse
Junction to structure

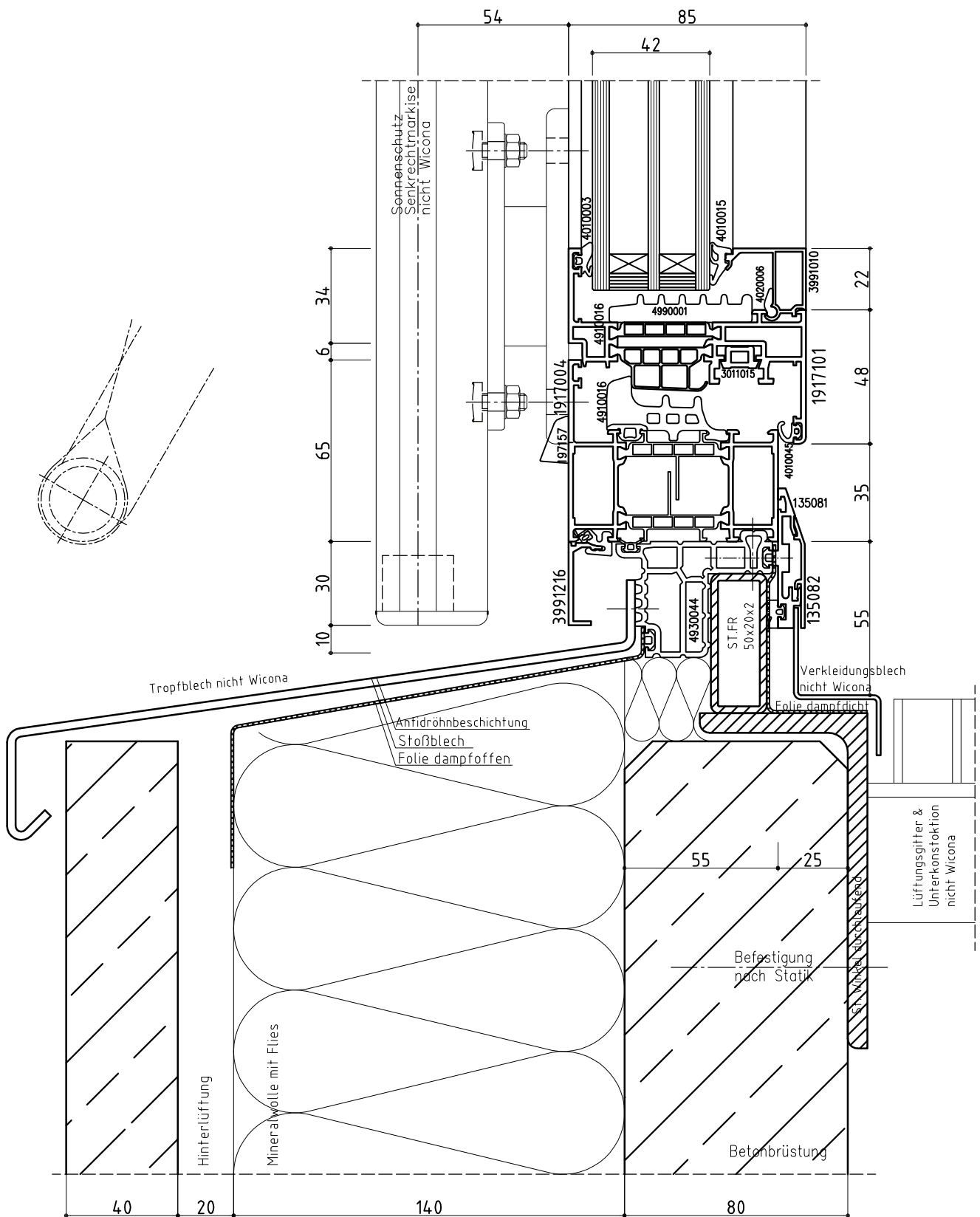

Der dargestellte Bauanschluss ist bauphysikalisch zu überprüfen.

The shown junction to the structure, has to be checked concerning the construction physics.

WICONA®

WICLINE 75

Bauanschluss unten - Maßstab 1:2

Bottom junction - Scale 1:2

Bauanschlüsse
Junction to structure

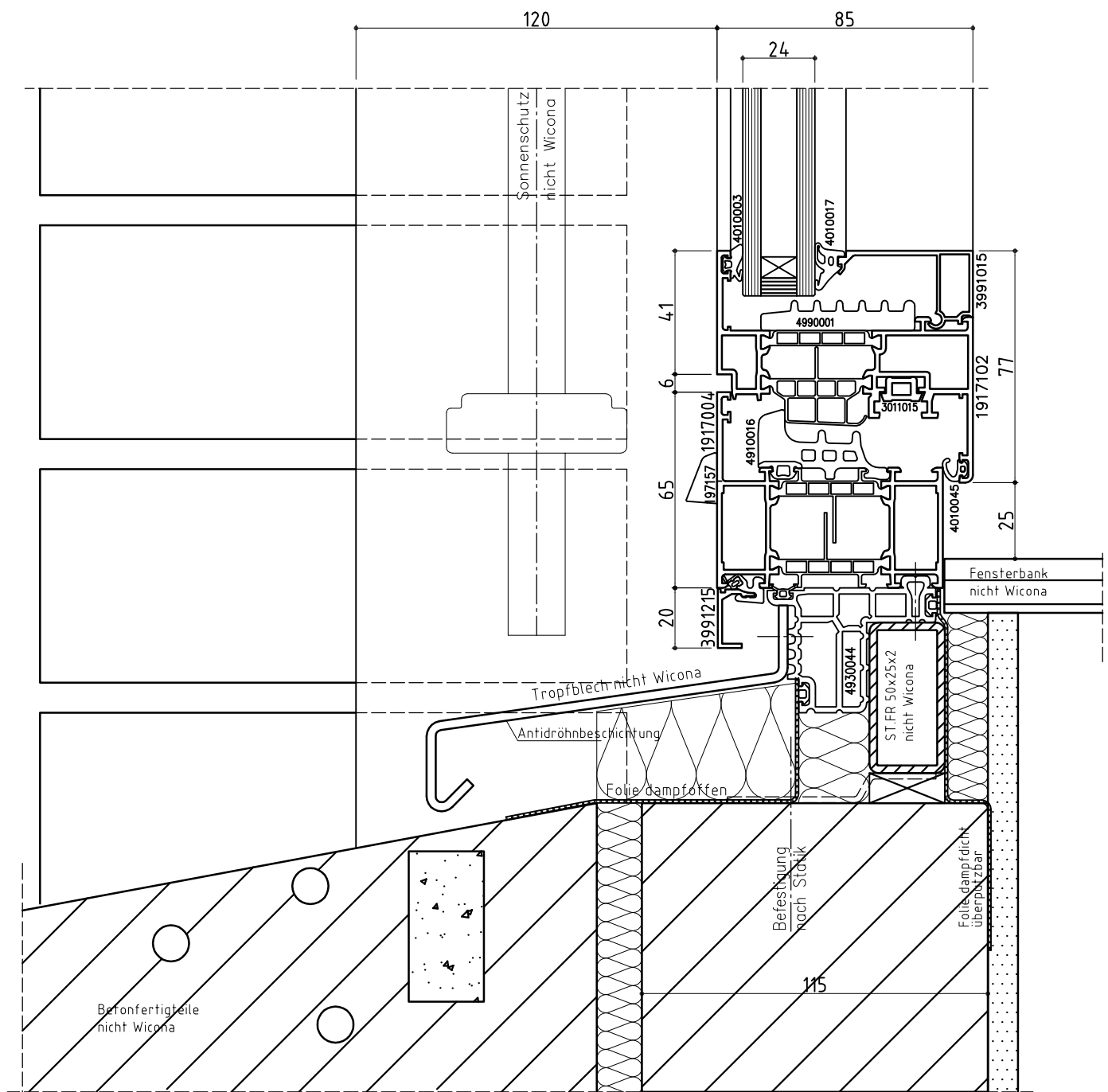

Der dargestellte Bauanschluss ist bauphysikalisch zu überprüfen.
The shown junction to the structure, has to be checked concerning the construction physics.

WICONA®

WICLINE 75

Bauanschlüsse
Junction to structure

Bauanschluss unten - Maßstab 1:2

Bottom junction - Scale 1:2

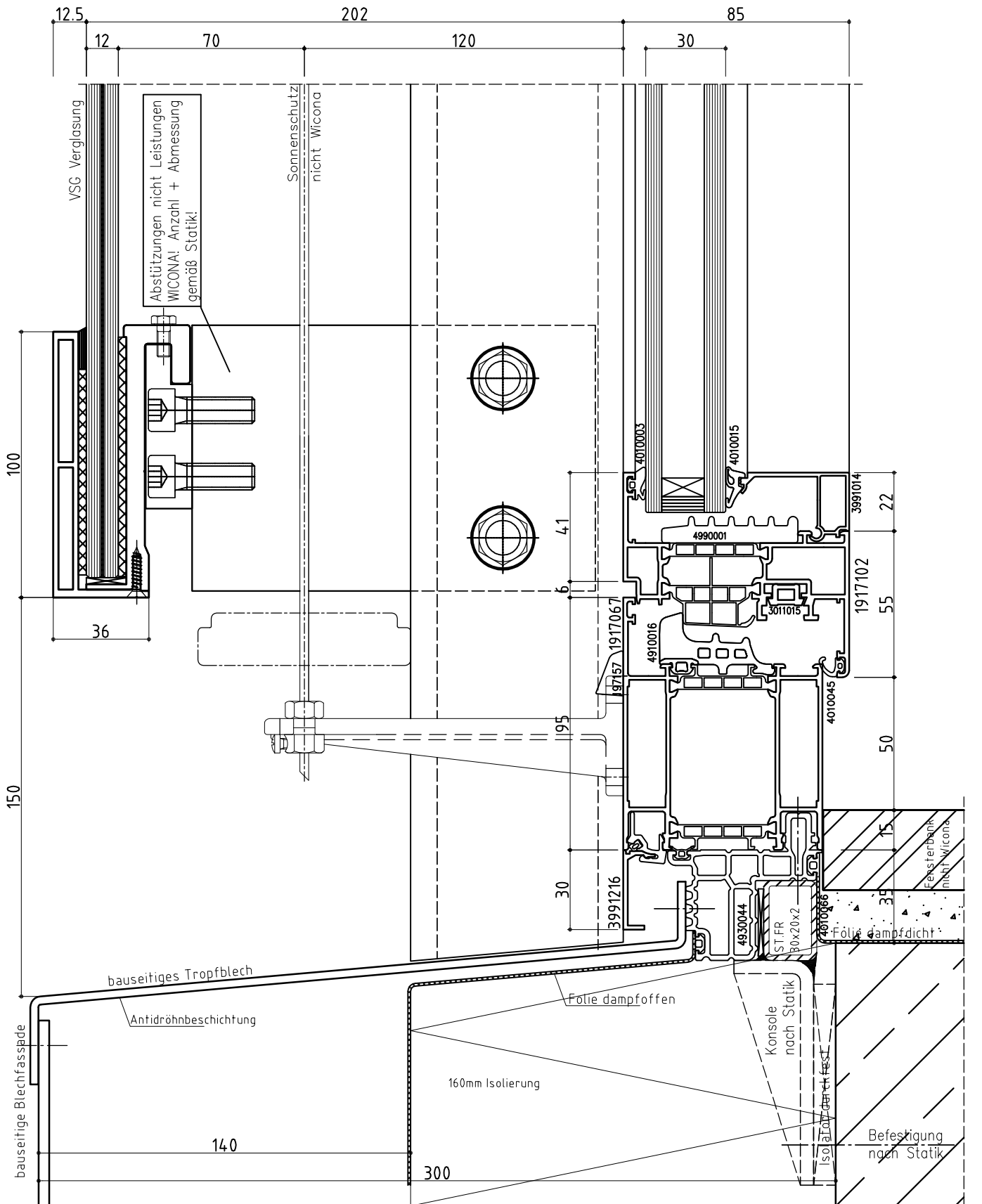

Der dargestellte Bauanschluss ist bauphysikalisch zu überprüfen.
The shown junction to the structure, has to be checked concerning the construction physics.

WICONA®

WICLINE 75

Bauanschluss unten - Maßstab 1:2

Bottom junction - Scale 1:2

Bauanschlüsse
Junction to structure

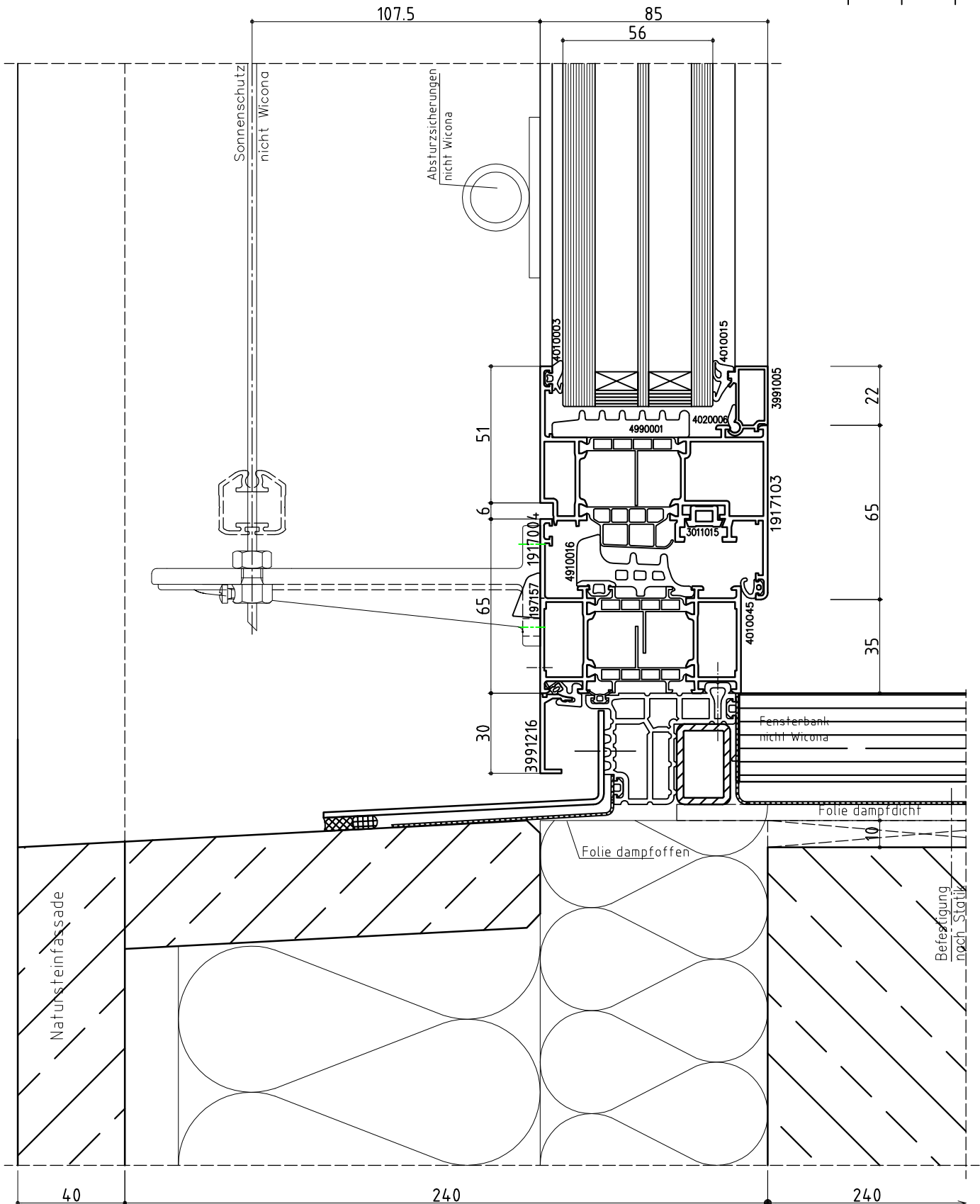

Der dargestellte Bauanschluss ist bauphysikalisch zu überprüfen.

The shown junction to the structure, has to be checked concerning the construction physics.

WICONA®

WICLINE 75

Bauanschluss unten - Maßstab 1:2

Bottom junction - Scale 1:2

Bauanschlüsse
Junction to structure

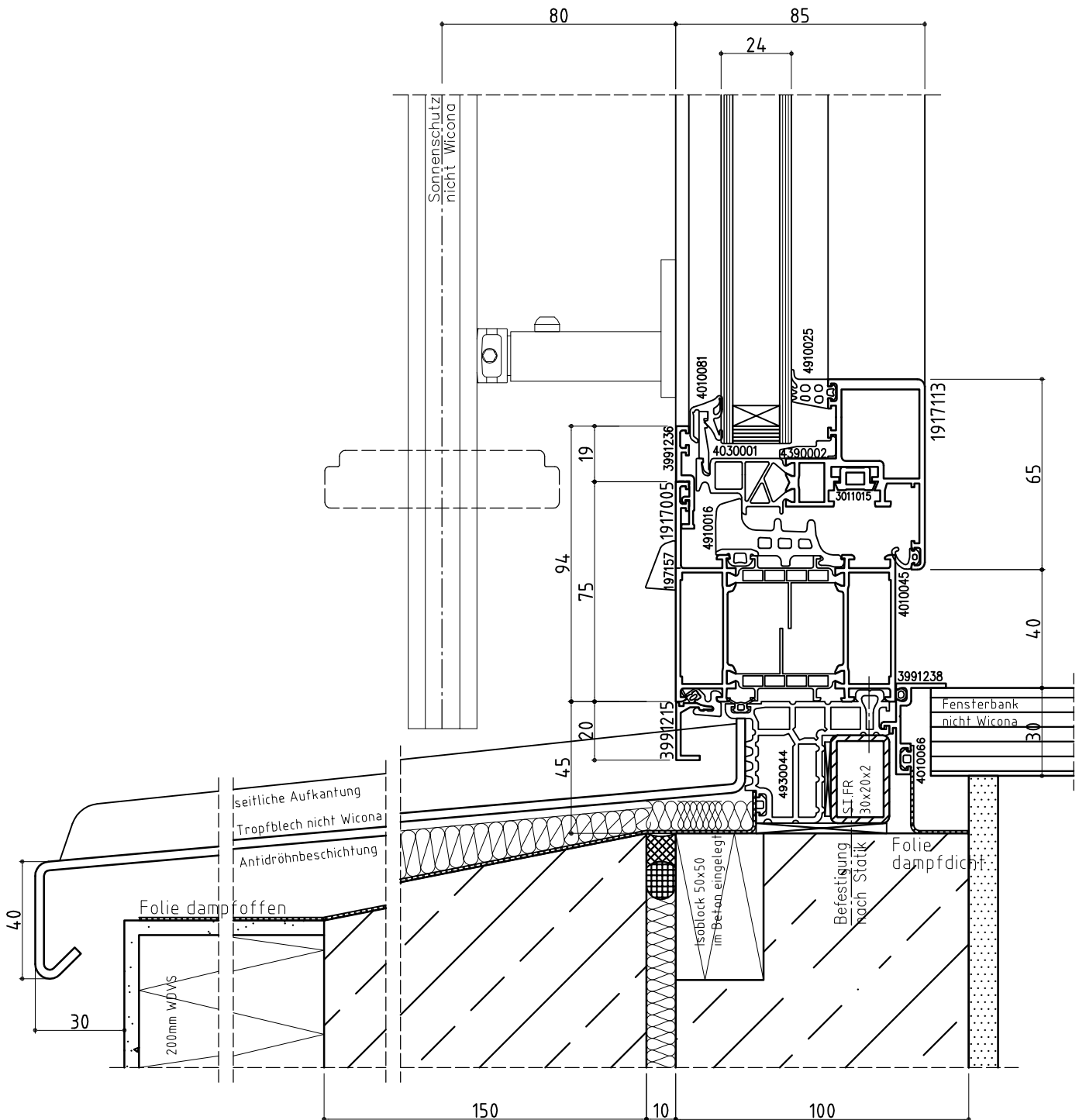

Der dargestellte Bauanschluss ist bauphysikalisch zu überprüfen.

The shown junction to the structure, has to be checked concerning the construction physics.

WICONA®

WICLINE 75

Bauanschluss seitlich - Maßstab 1:2

Lateral termination - Scale 1:2

Bauanschlüsse
Junction to structure

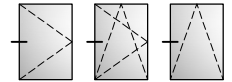

Hinweise zum Konstruktionsvorschlag:

- Es gelten die Verarbeitungsrichtlinien der Wicona-Programme
- Die Dimensionierung der Profile, Verarbeitungsmittel, Verankerungen, Dübel, Schrauben und Verglasungen müssen der statischen Berechnung den gültigen Normen und Vorschriften entsprechen und werden eigenverantwortlich durch die ausführende Firma festgelegt.
- Die dargestellten Bauanschlüsse sind bauphysikalisch zu überprüfen.
- Die fachgerechte Ausführung liegt im Verantwortungsbereich der ausführenden Firma.
- WICONA wird hierfür keine Gewähr übernehmen.

Comments to the Construction offer:

- Processing guidelines, according to the Wicona workshop manuals
- The dimensioning of the profiles, processing means anchors, frame dowels, screws and glasses, has to be done according to the valid standards, regulations and according to the statical calculations. This has to be done self-dependent by the construction company.
- The shown junction to the structure, has to be checked concerning the construction physics.
- The professional workmanship, is in the area of responsibility of the manufacturer.
- Wicona will not give any warranty on this.

WICLINE 75

Bauanschluss seitlich - Maßstab 1:2

Lateral termination - Scale 1:2

Bauanschlüsse
Junction to structure

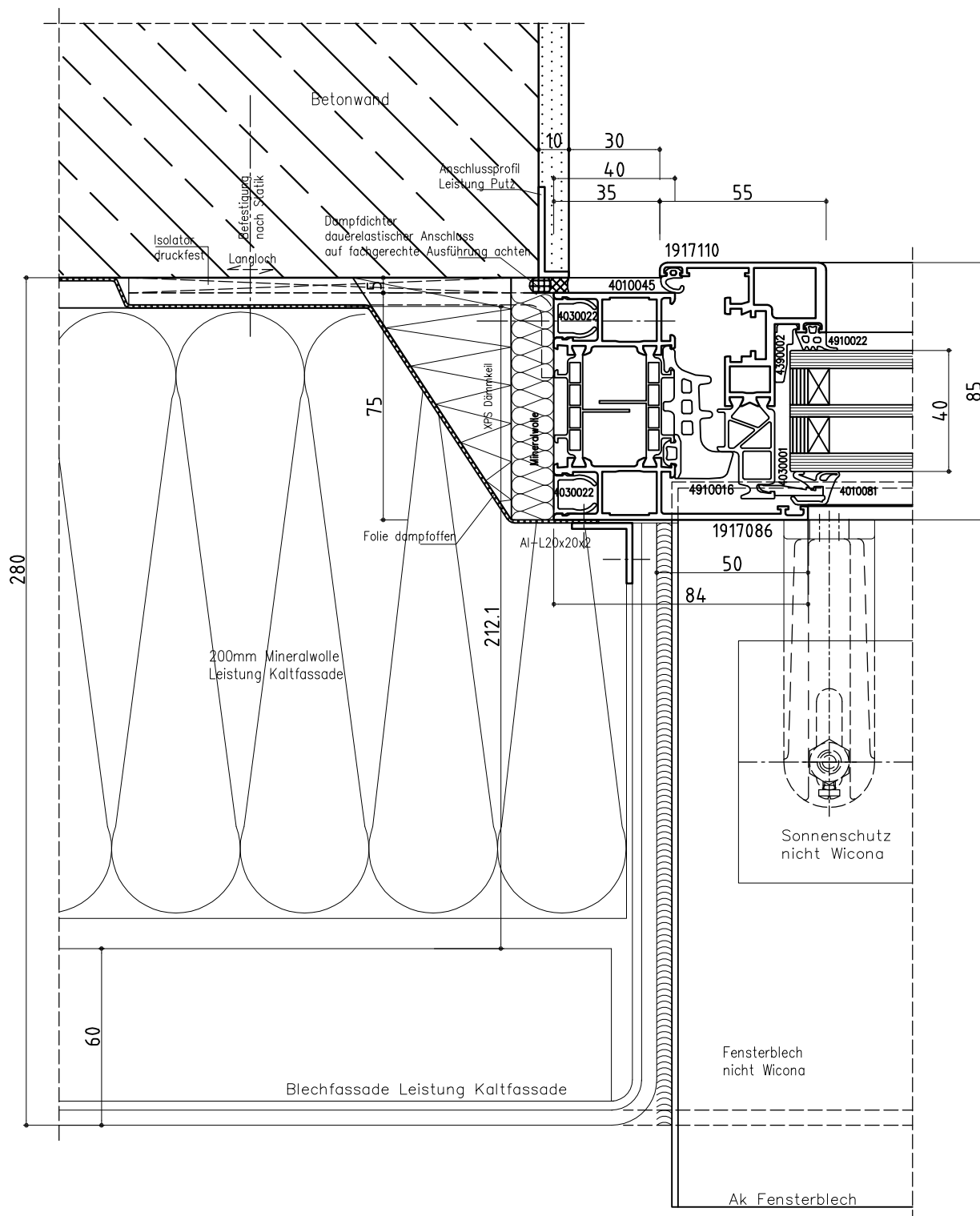
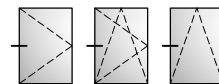

Der dargestellte Bauanschluss ist bauphysikalisch zu überprüfen.
The shown junction to the structure, has to be checked concerning the construction physics.

WICONA®

WICLINE 75

Bauanschluss seitlich - Maßstab 1:2

Lateral termination - Scale 1:2

Bauanschlüsse
Junction to structure

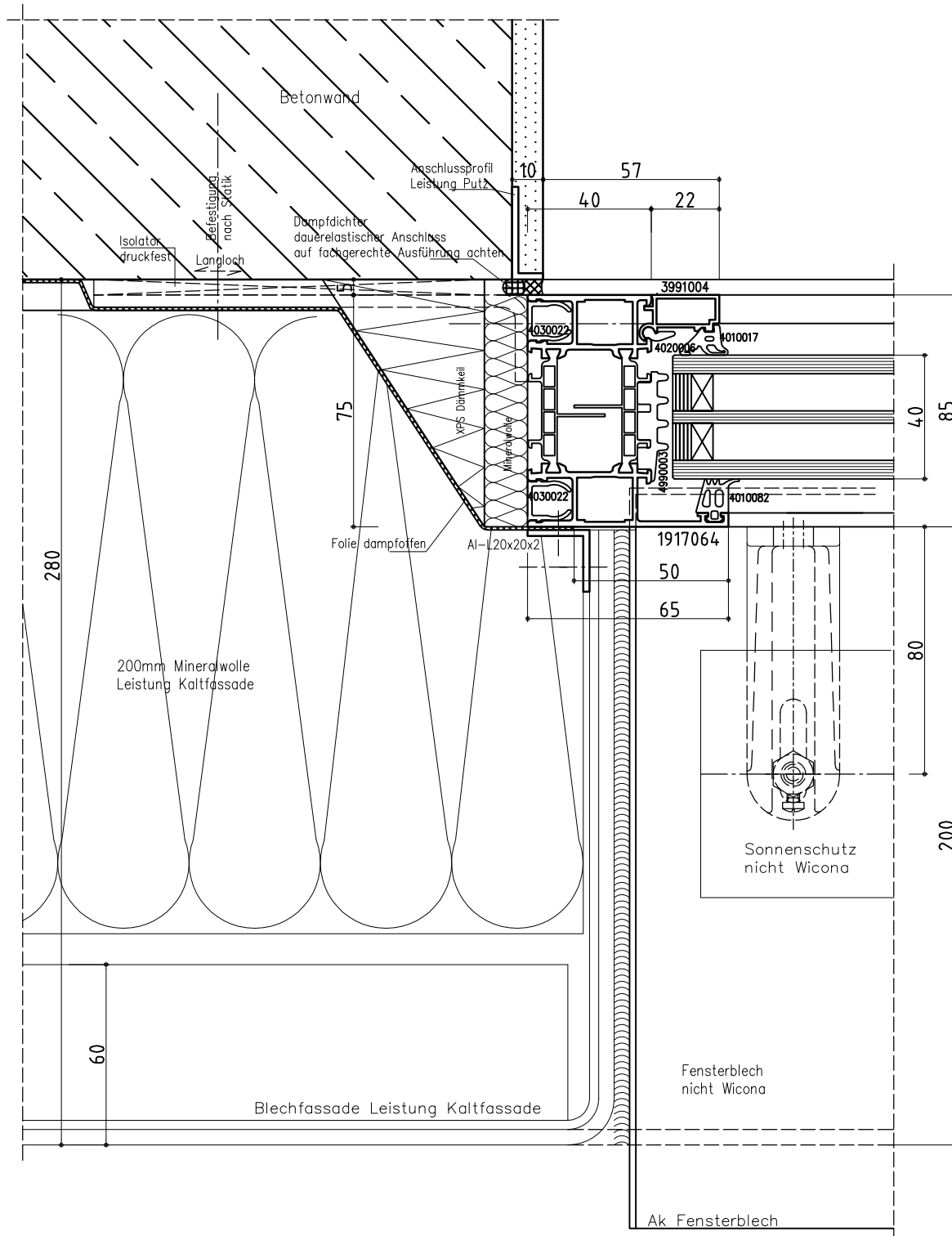

Der dargestellte Bauanschluss ist bauphysikalisch zu überprüfen.
The shown junction to the structure, has to be checked concerning the construction physics.

WICONA®

WICLINE 75

Bauanschluss seitlich - Maßstab 1:2

Lateral termination - Scale 1:2

Bauanschlüsse
Junction to structure

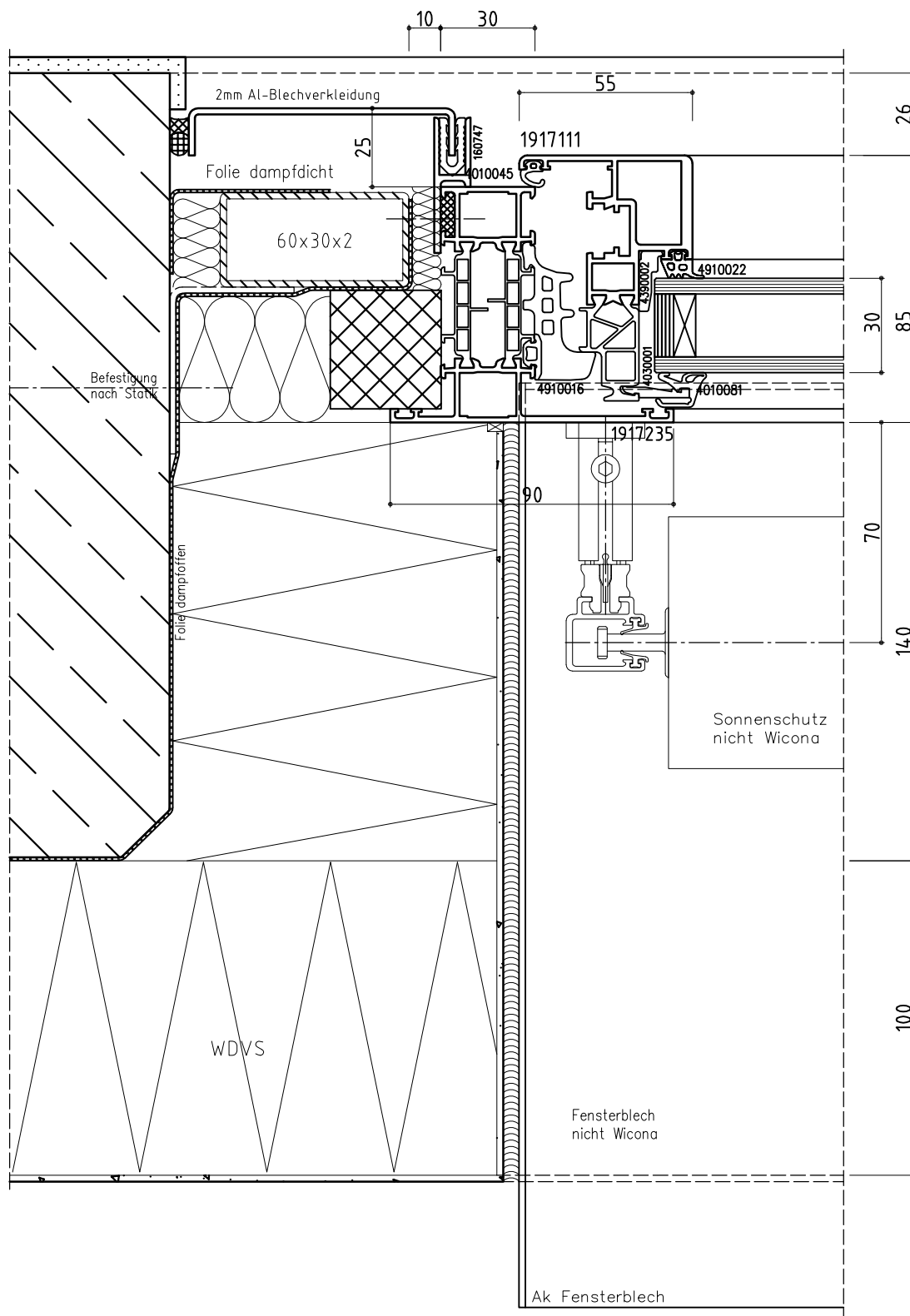
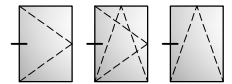

Der dargestellte Bauanschluss ist bauphysikalisch zu überprüfen.
The shown junction to the structure, has to be checked concerning the construction physics.

WICONA®

WICLINE 75

Bauanschluss seitlich - Maßstab 1:2

Lateral termination - Scale 1:2

Bauanschlüsse
Junction to structure

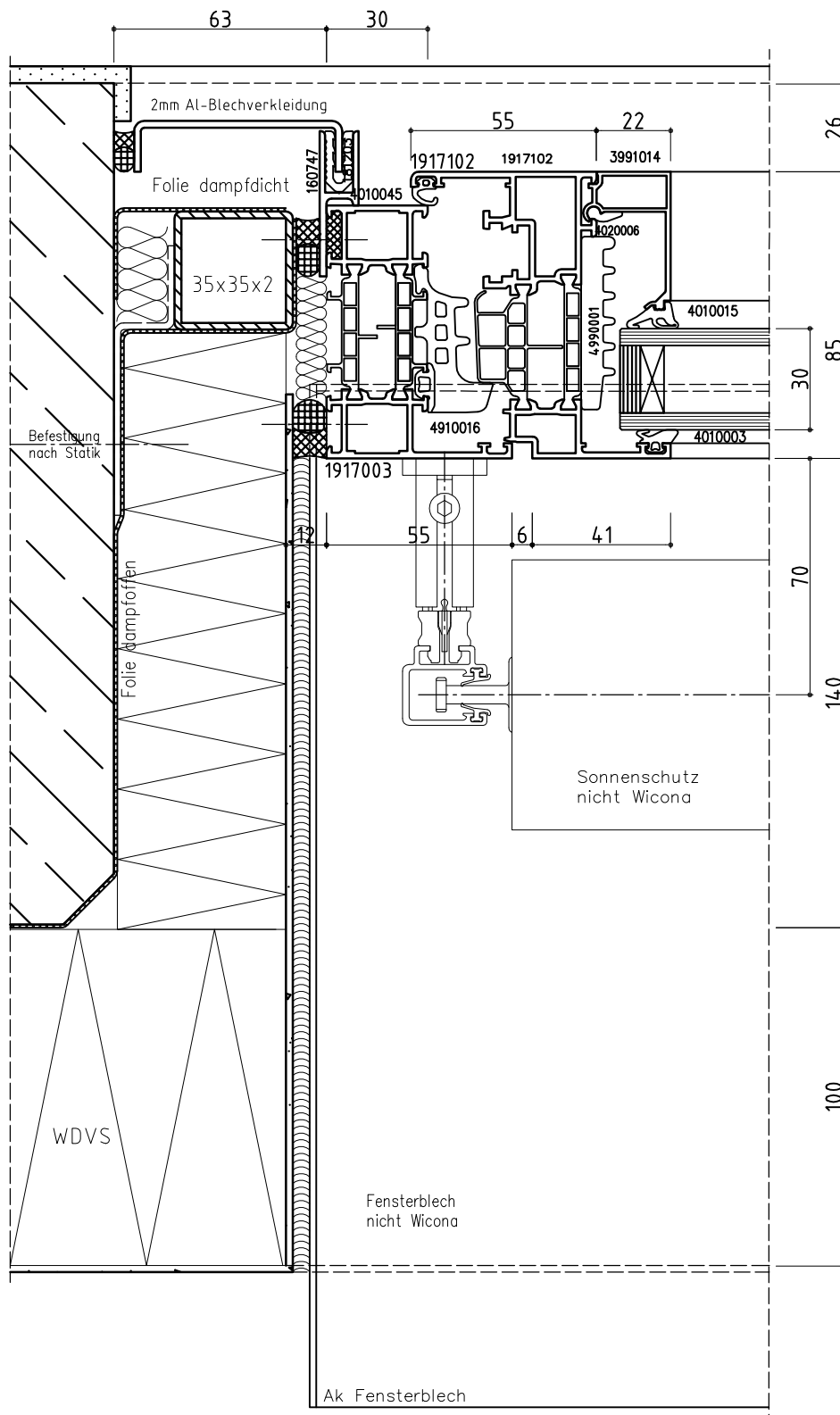
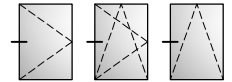

Der dargestellte Bauanschluss ist bauphysikalisch zu überprüfen.
 The shown junction to the structure, has to be checked concerning the construction physics.

WICONA®

WICLINE 75

Bauanschluss seitlich - Maßstab 1:2

Lateral termination - Scale 1:2

Bauanschlüsse
Junction to structure

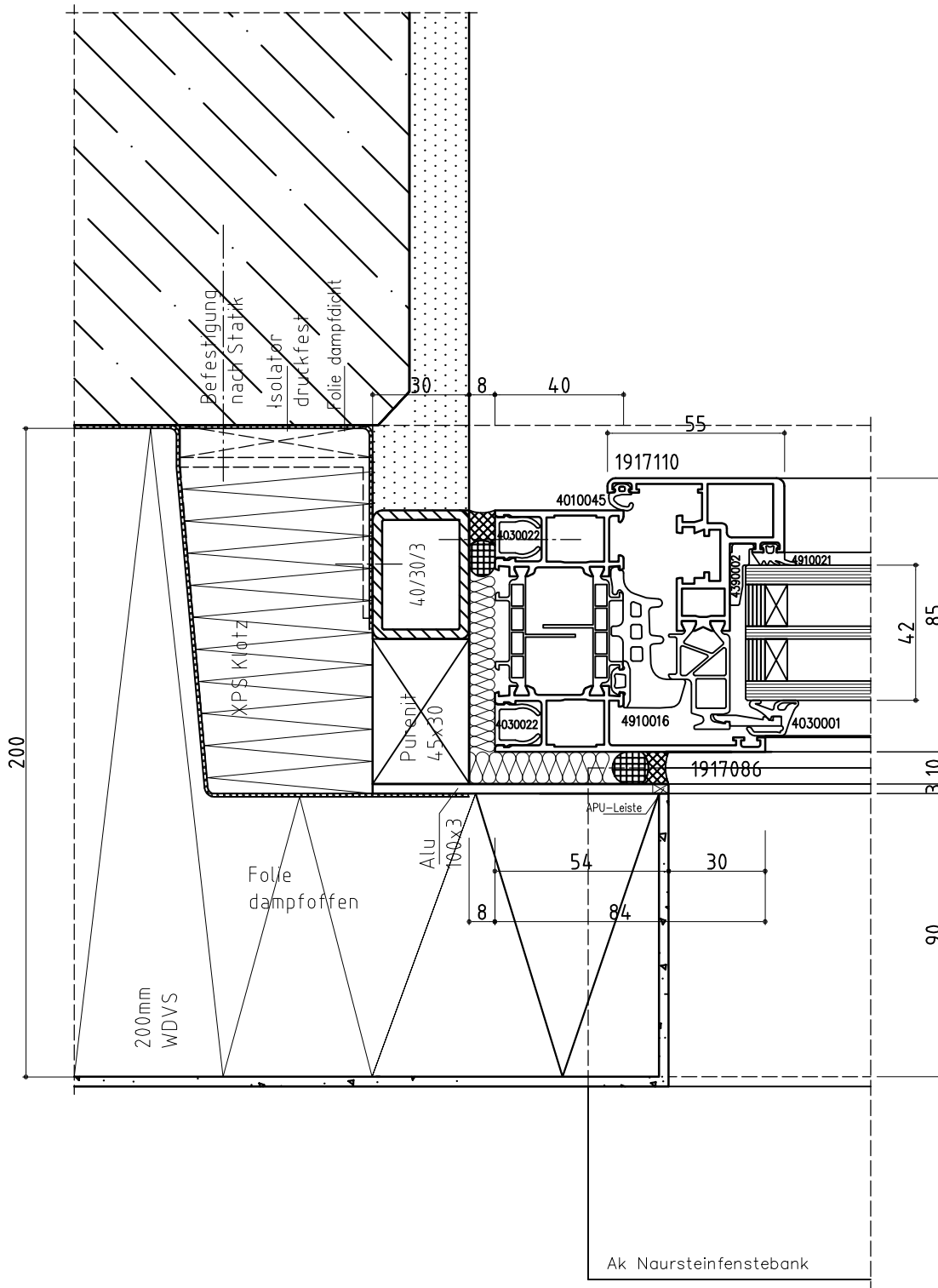
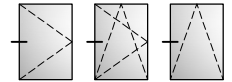

Der dargestellte Bauanschluss ist bauphysikalisch zu überprüfen.
The shown junction to the structure, has to be checked concerning the construction physics.

WICONA®

WICLINE 75

Bauanschluss seitlich - Maßstab 1:2

Lateral termination - Scale 1:2

Bauanschlüsse
Junction to structure

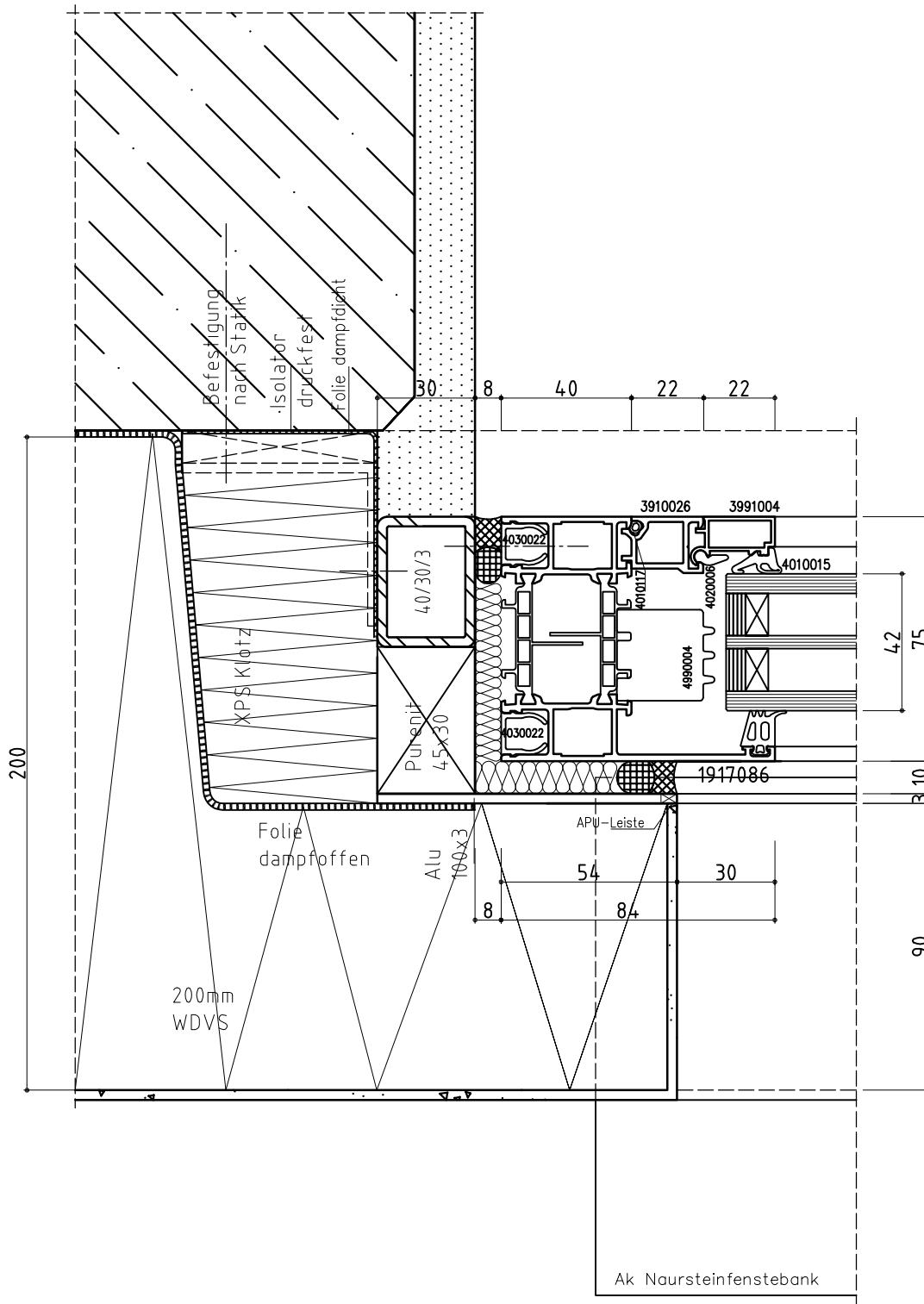

Der dargestellte Bauanschluss ist bauphysikalisch zu überprüfen.
The shown junction to the structure, has to be checked concerning the construction physics.

WICONA®

WICLINE 75

Bauanschluss seitlich - Maßstab 1:2

Lateral termination - Scale 1:2

Bauanschlüsse
Junction to structure

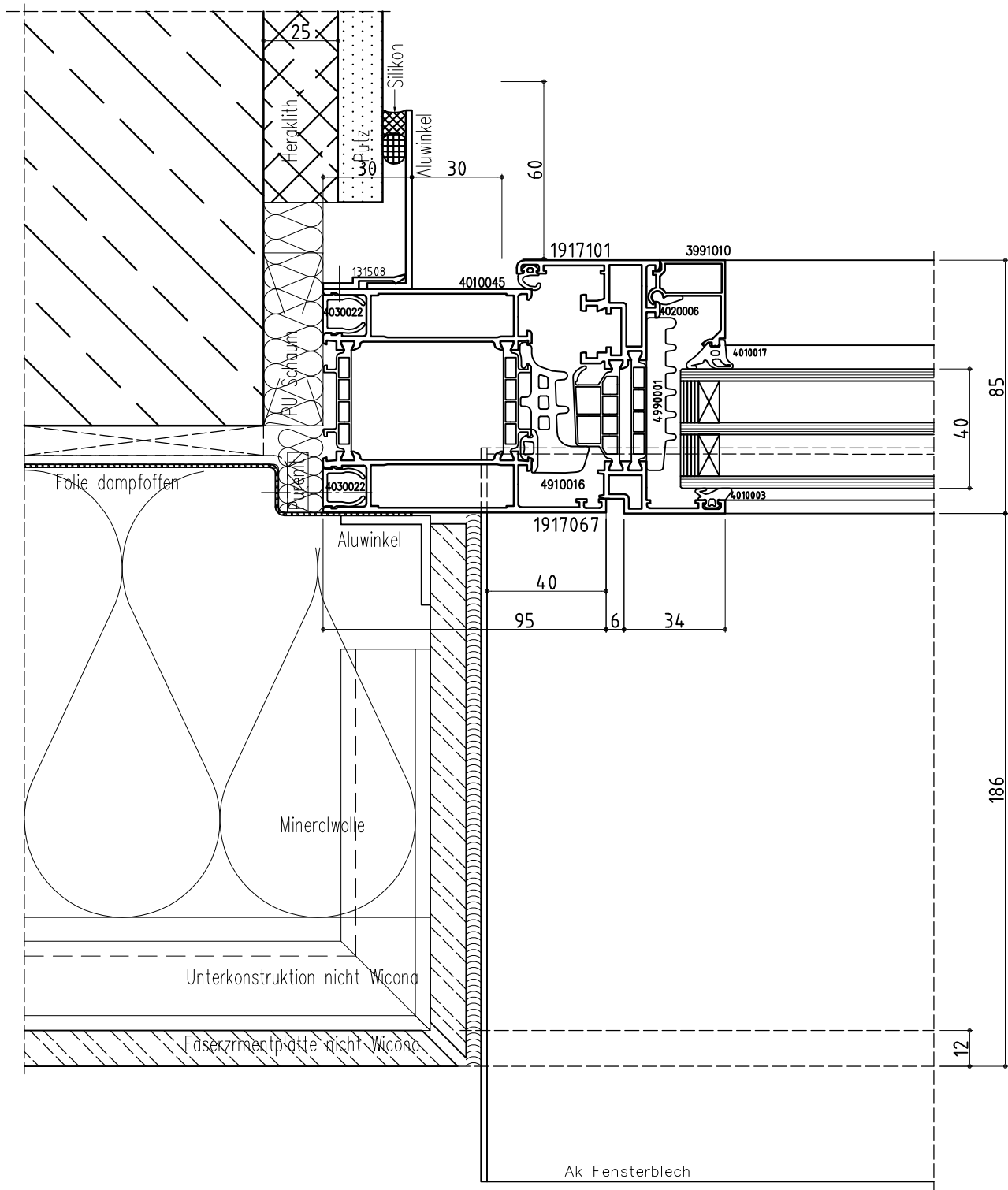
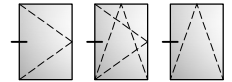

Der dargestellte Bauanschluss ist bauphysikalisch zu überprüfen.
The shown junction to the structure, has to be checked concerning the construction physics.

WICONA®

WICLINE 75

Bauanschluss seitlich - Maßstab 1:2

Lateral termination - Scale 1:2

Bauanschlüsse
Junction to structure

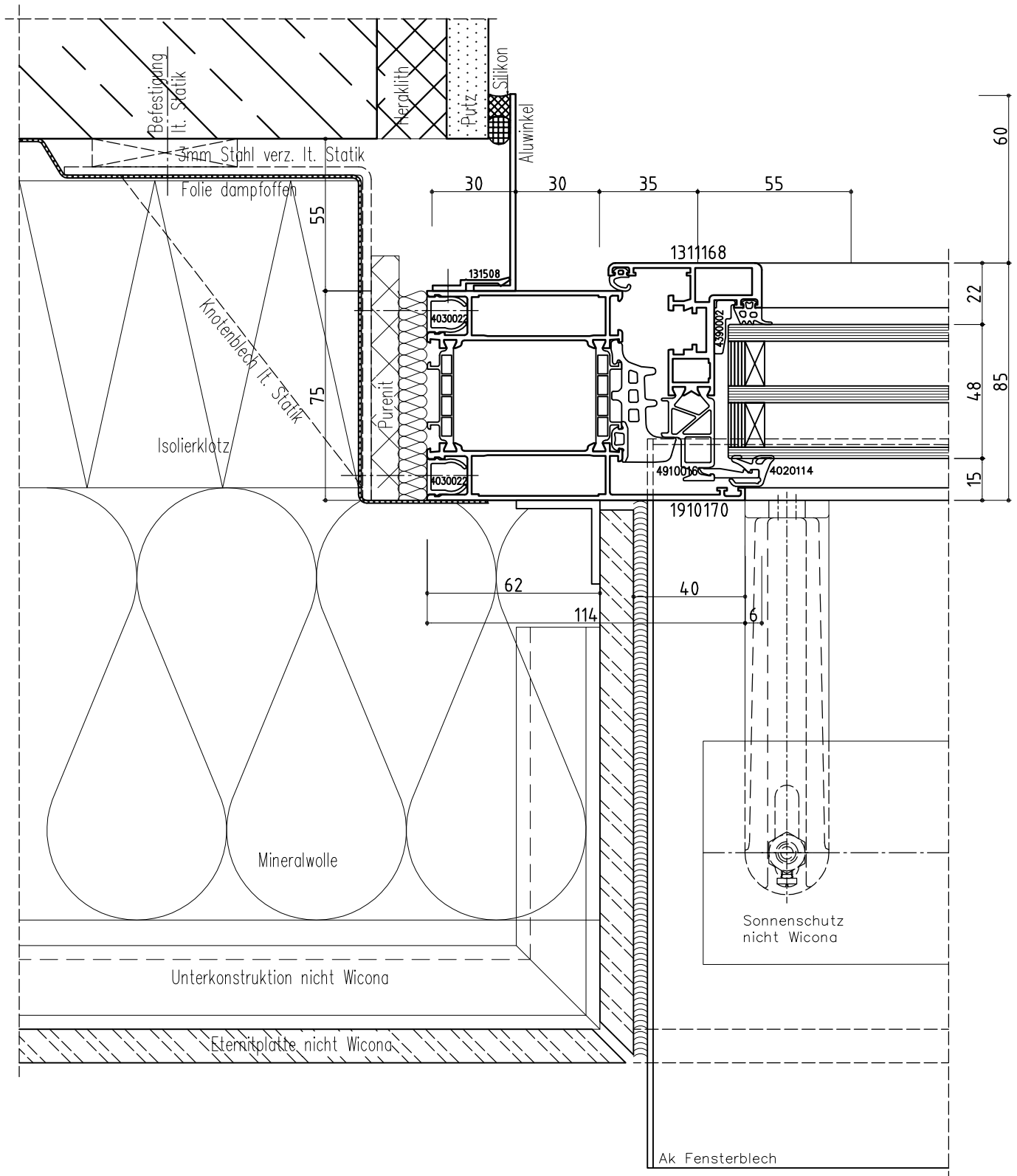
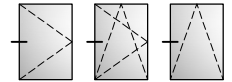

Der dargestellte Bauanschluss ist bauphysikalisch zu überprüfen.
 The shown junction to the structure, has to be checked concerning the construction physics.

WICONA®

WICLINE 75

Bauanschluss seitlich - Maßstab 1:2

Lateral termination - Scale 1:2

Bauanschlüsse
Junction to structure

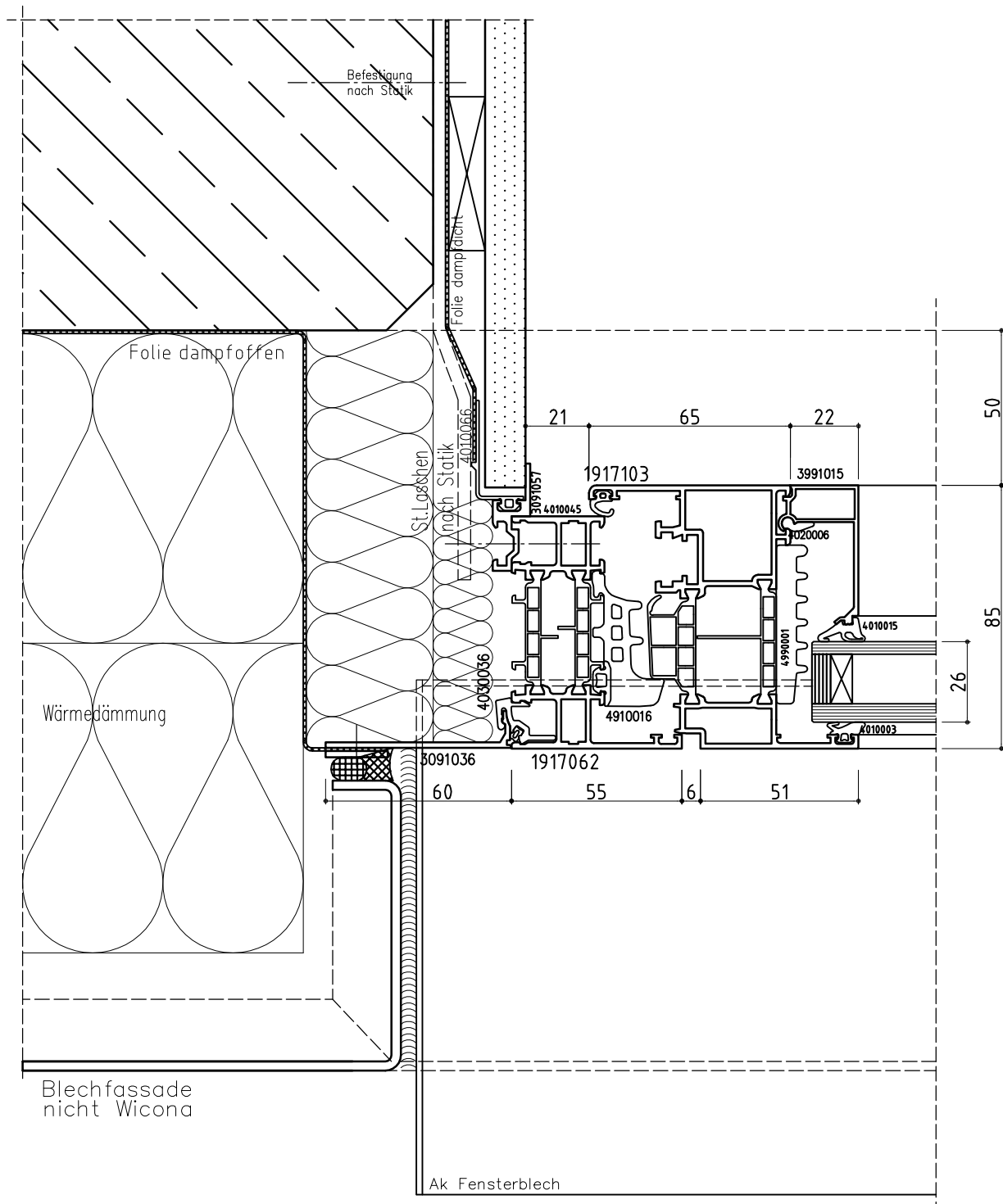
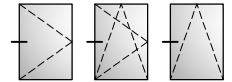

Der dargestellte Bauanschluss ist bauphysikalisch zu überprüfen.
The shown junction to the structure, has to be checked concerning the construction physics.

WICONA®

WICLINE 75

Bauanschluss seitlich - Maßstab 1:2

Lateral termination - Scale 1:2

Bauanschlüsse
Junction to structure

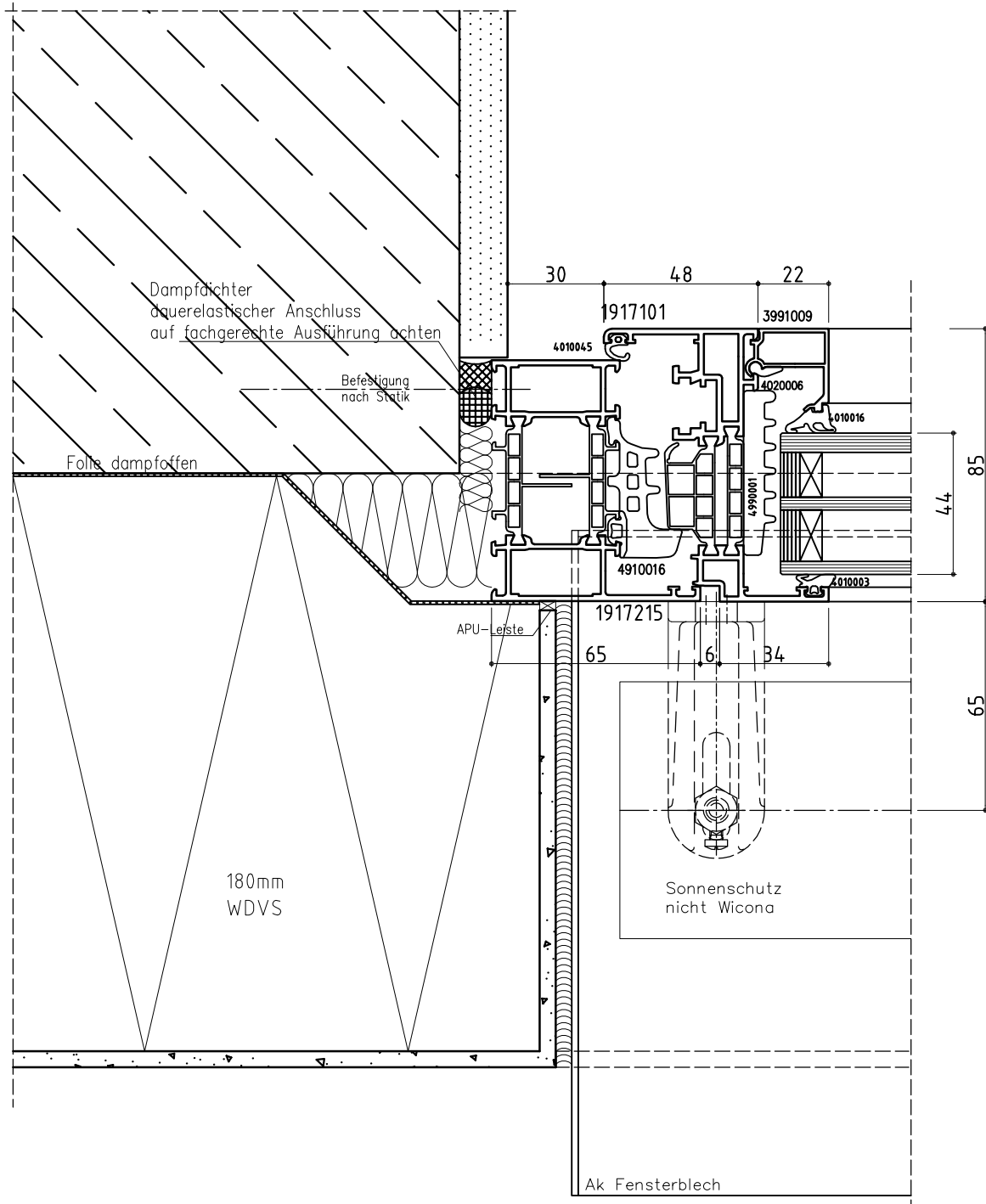
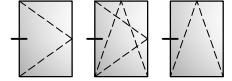

Der dargestellte Bauanschluss ist bauphysikalisch zu überprüfen.
The shown junction to the structure, has to be checked concerning the construction physics.

WICLINE 75

Bauanschluss seitlich - Maßstab 1:2

Lateral termination - Scale 1:2

Bauanschlüsse
Junction to structure

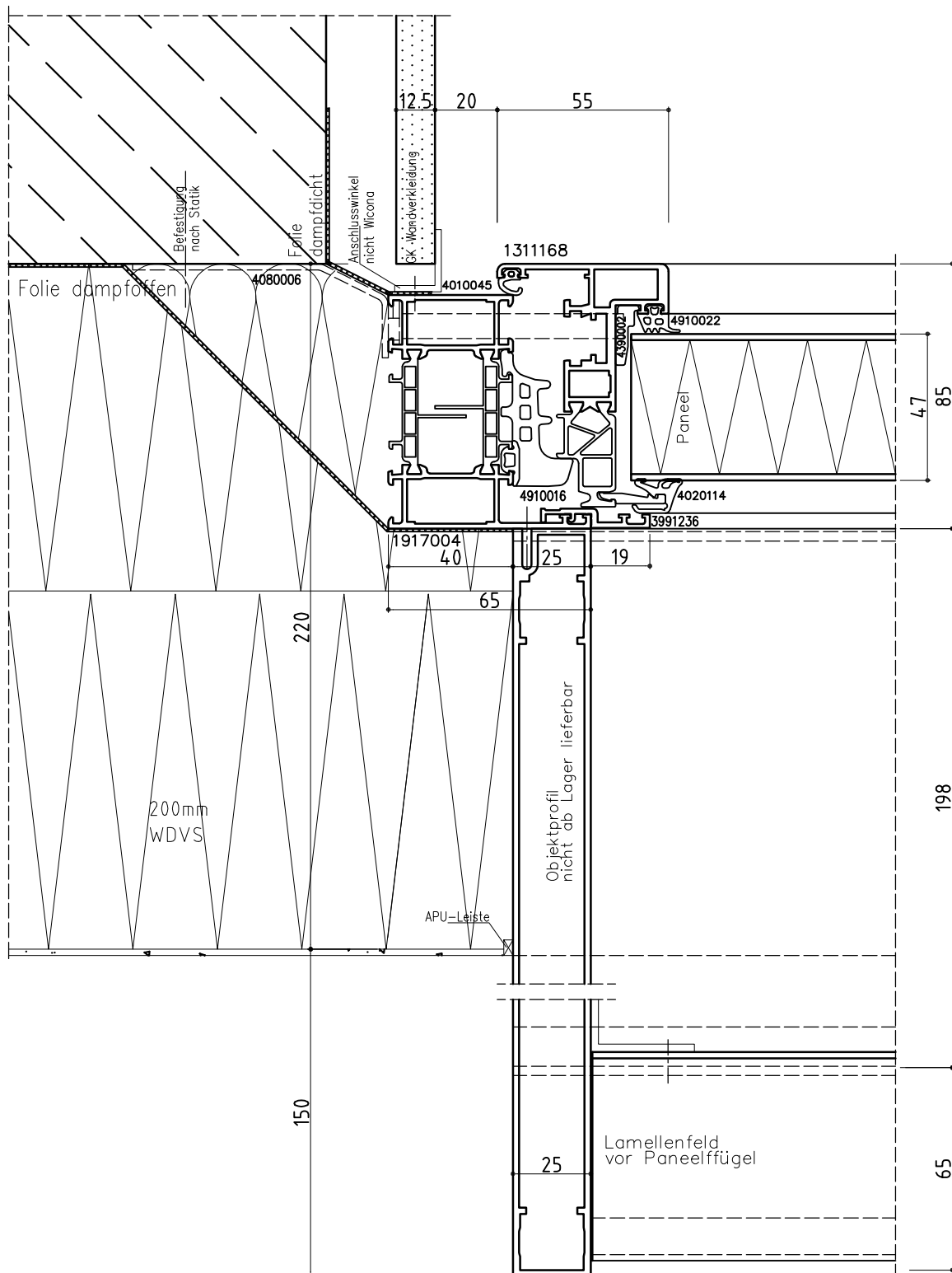
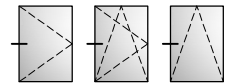

Der dargestellte Bauanschluss ist bauphysikalisch zu überprüfen.
The shown junction to the structure, has to be checked concerning the construction physics.

WICONA®

WICLINE 75

Bauanschluss seitlich - Maßstab 1:2

Lateral termination - Scale 1:2

Bauanschlüsse
Junction to structure

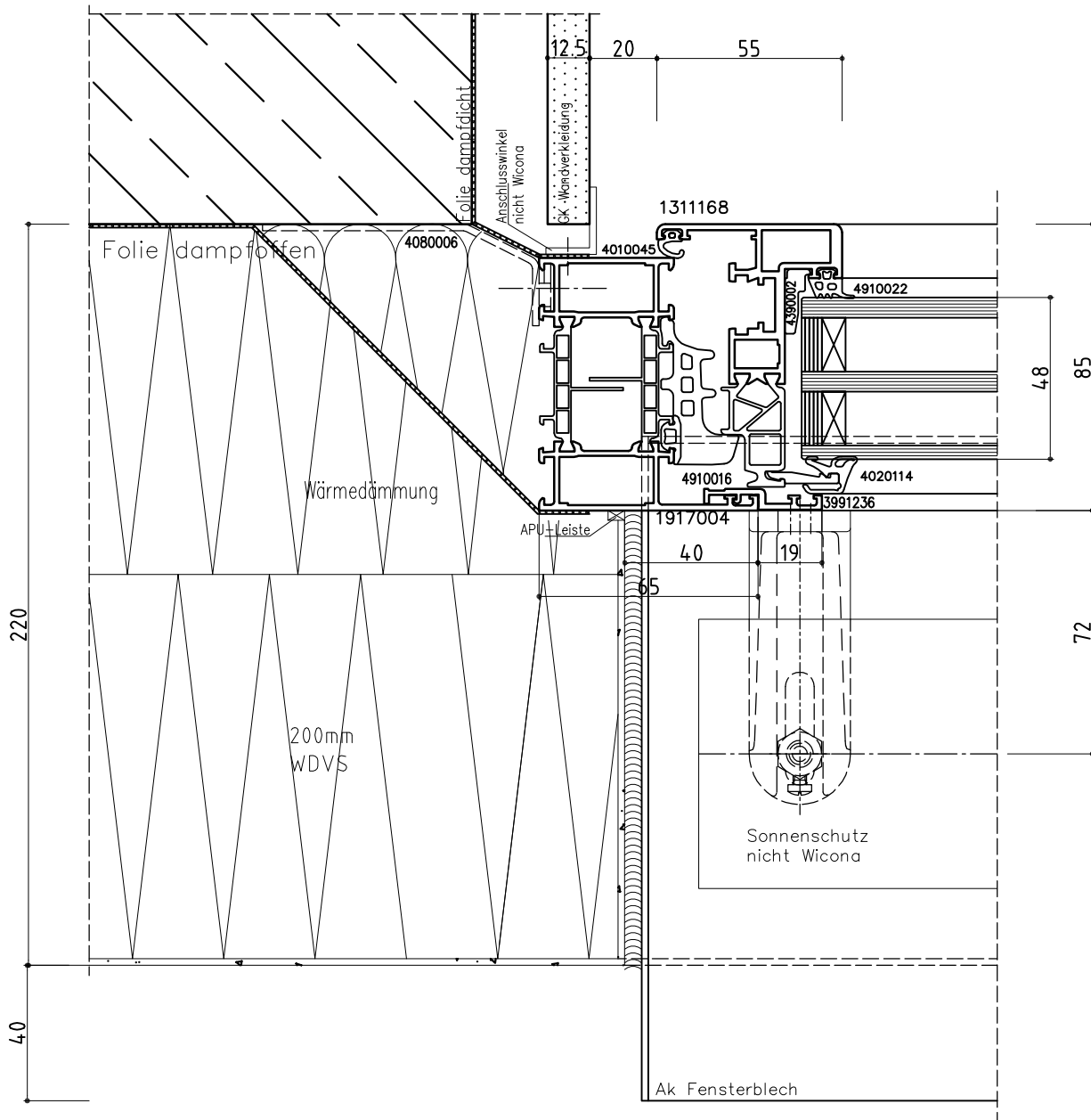

Der dargestellte Bauanschluss ist bauphysikalisch zu überprüfen.
The shown junction to the structure, has to be checked concerning the construction physics.

WICLINE 75

Bauanschluss seitlich - Maßstab 1:2

Lateral termination - Scale 1:2

Bauanschlüsse
Junction to structure

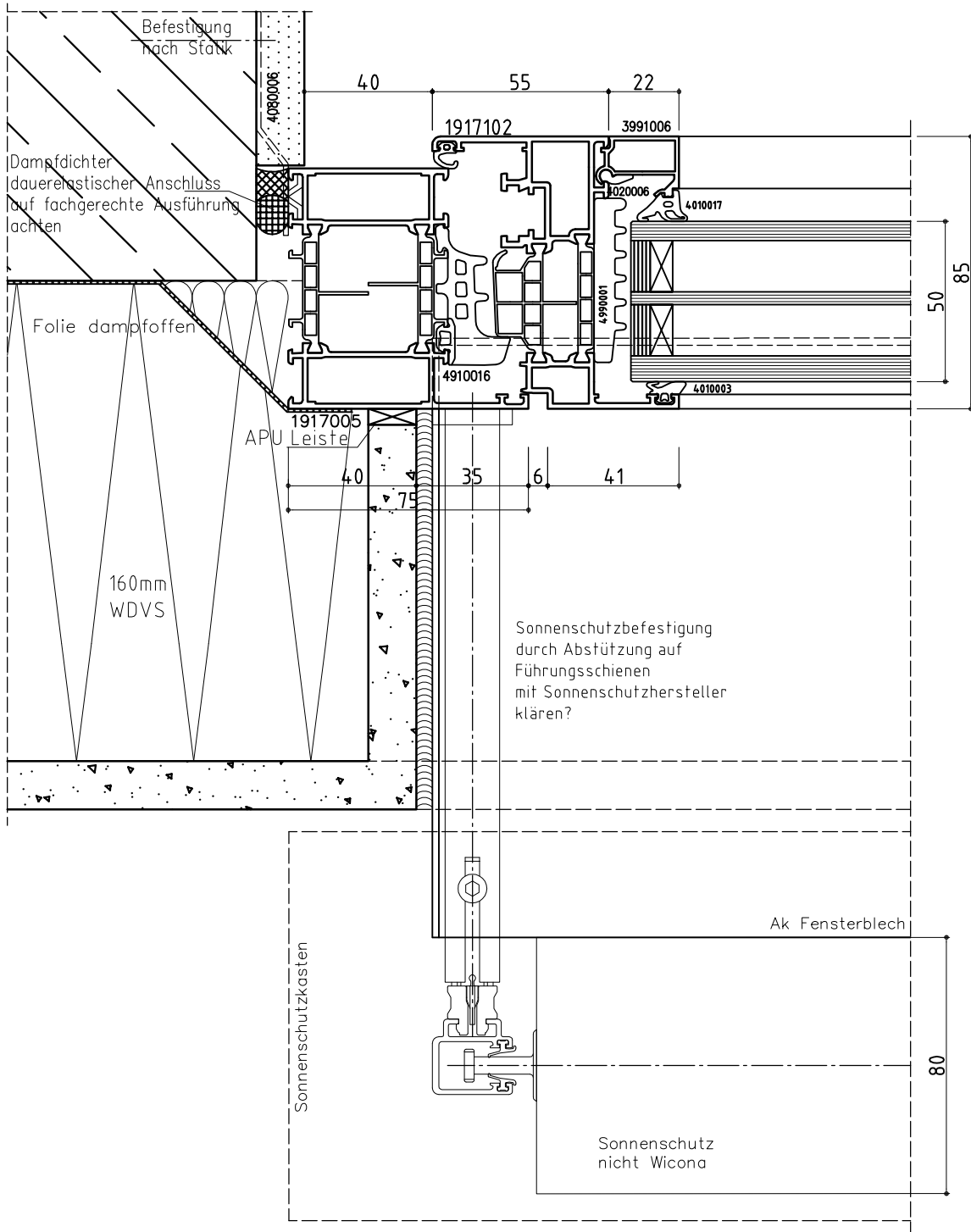

Der dargestellte Bauanschluss ist bauphysikalisch zu überprüfen.
The shown junction to the structure, has to be checked concerning the construction physics.

WICLINE 75

Bauanschluss seitlich - Maßstab 1:2

Lateral termination - Scale 1:2

Bauanschlüsse
Junction to structure

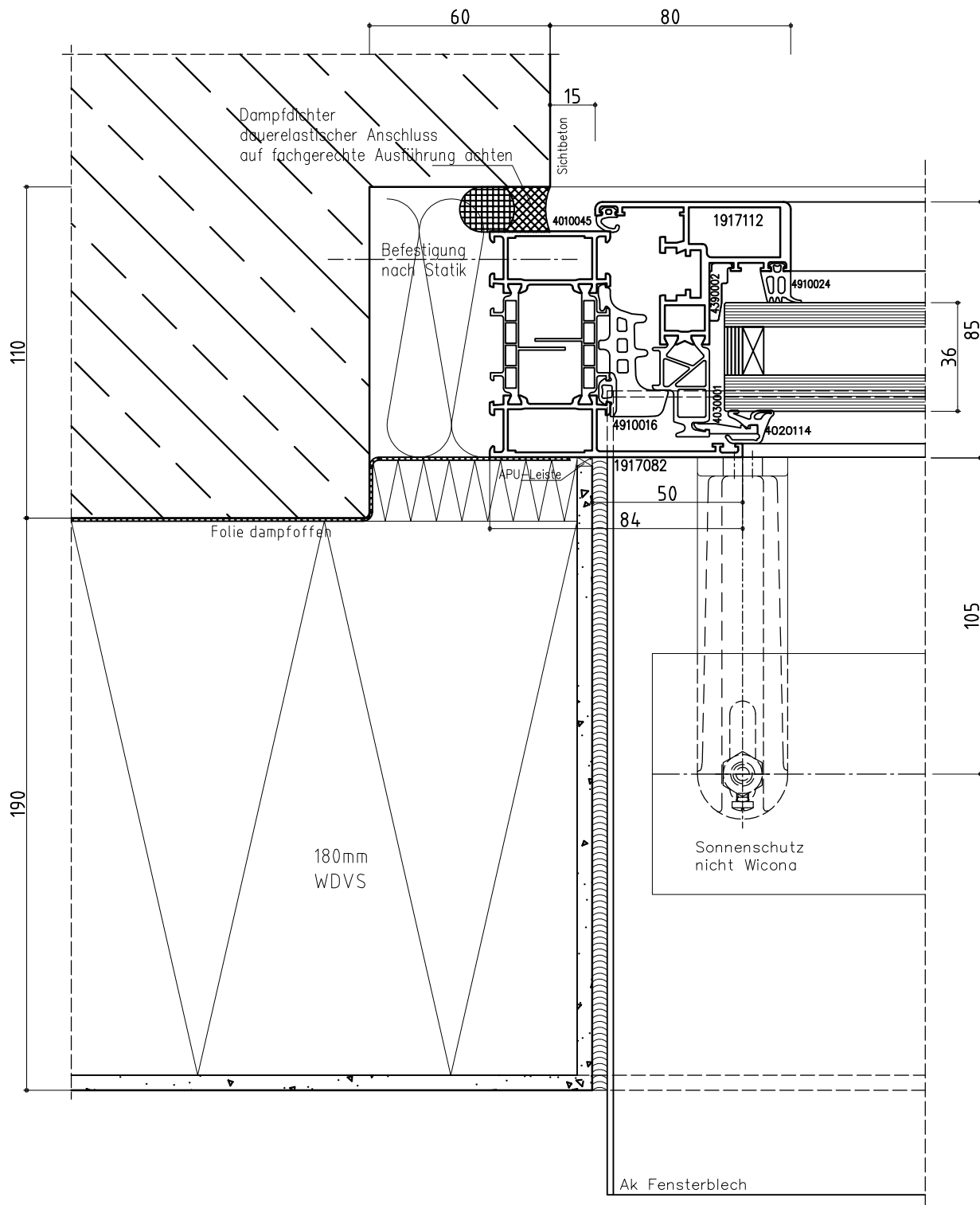
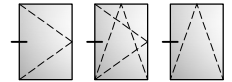

Der dargestellte Bauanschluss ist bauphysikalisch zu überprüfen.
The shown junction to the structure, has to be checked concerning the construction physics.

WICONA®

WICLINE 75

Bauanschluss seitlich - Maßstab 1:2

Lateral termination - Scale 1:2

Bauanschlüsse
Junction to structure

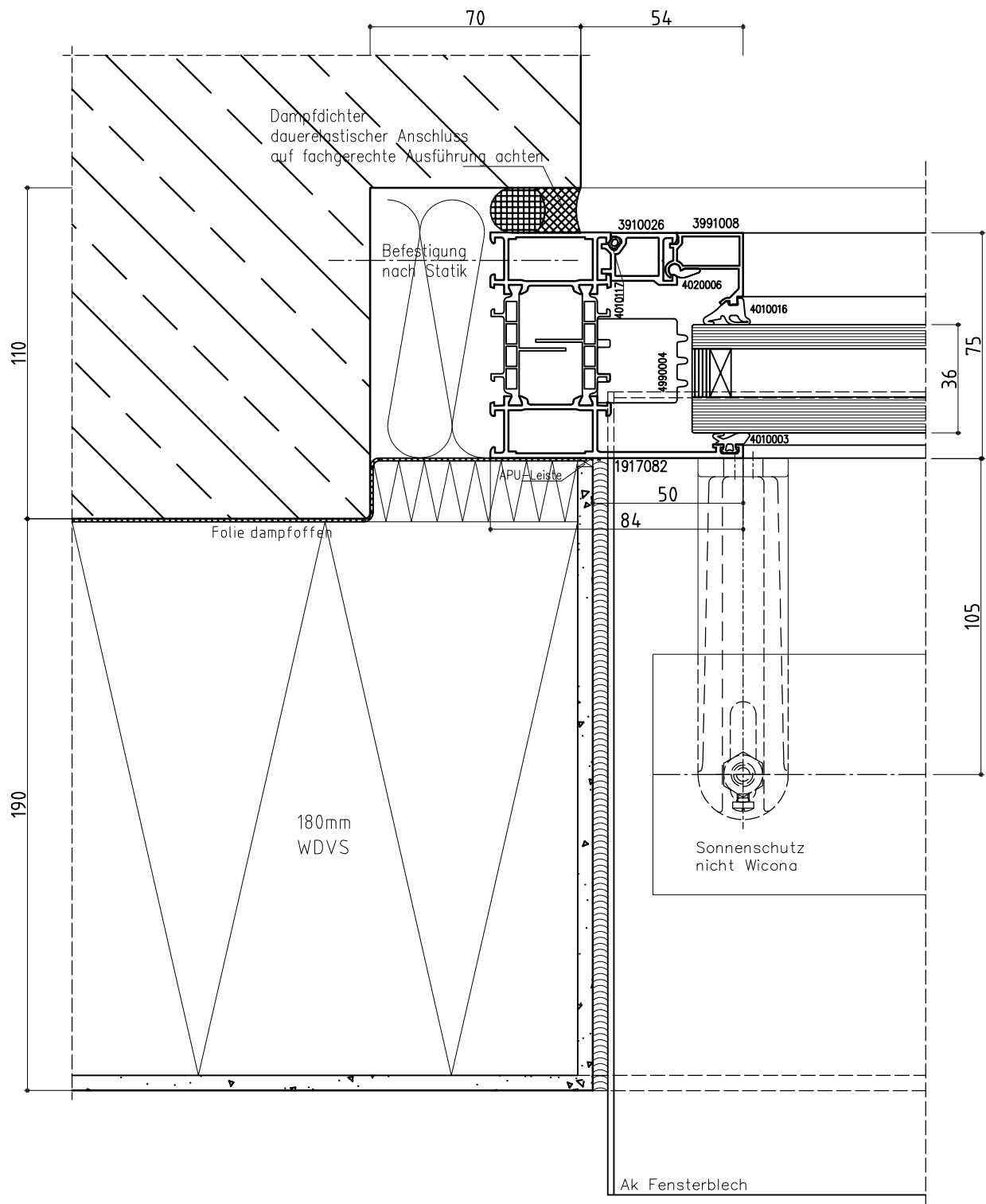

Der dargestellte Bauanschluss ist bauphysikalisch zu überprüfen.
The shown junction to the structure, has to be checked concerning the construction physics.

WICONA®

WICLINE 75

Bauanschluss seitlich - Maßstab 1:2

Lateral termination - Scale 1:2

Bauanschlüsse
Junction to structure

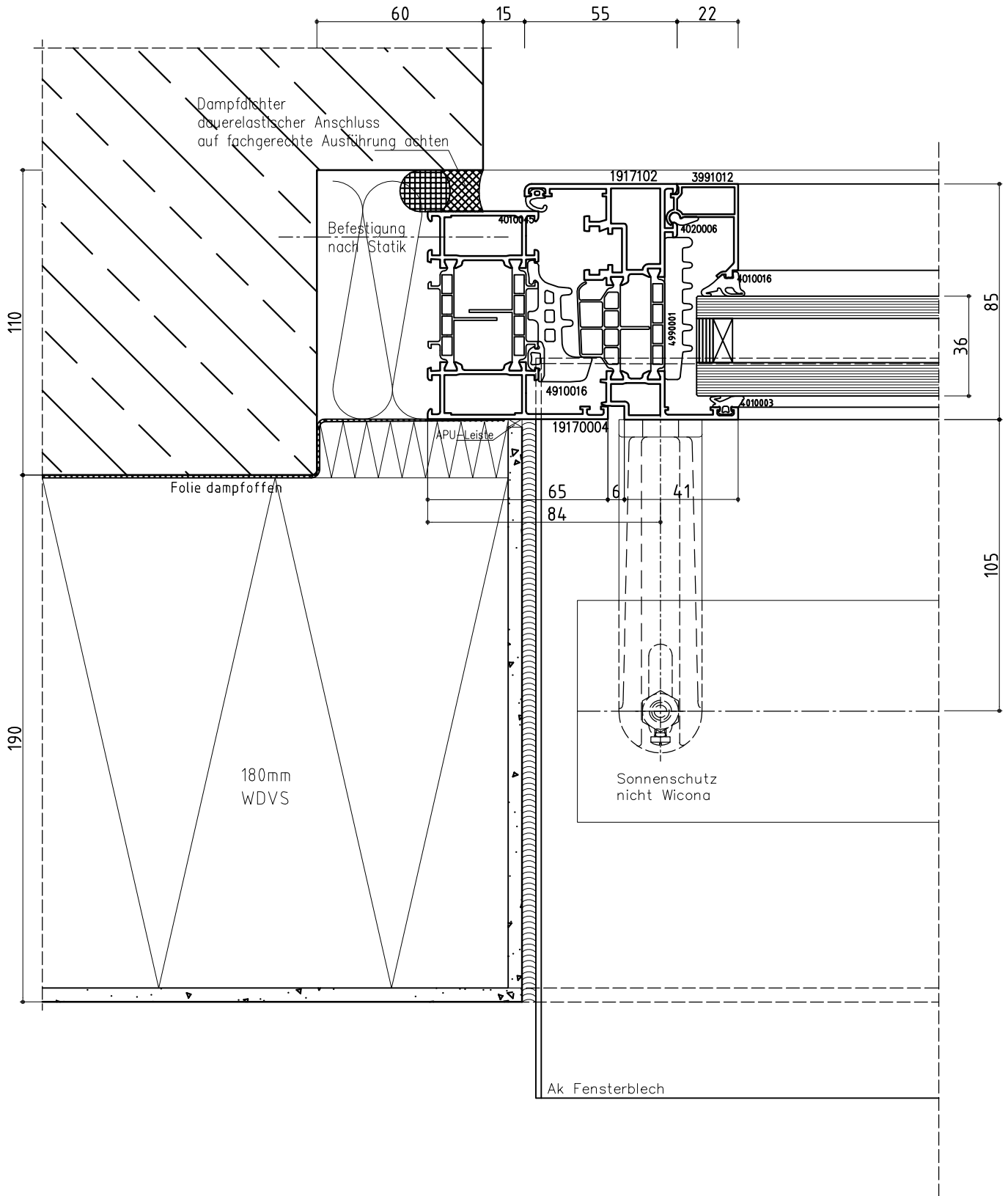

Der dargestellte Bauanschluss ist bauphysikalisch zu überprüfen.
The shown junction to the structure, has to be checked concerning the construction physics.

WICONA®

WICLINE 75

Bauanschluss seitlich - Maßstab 1:2

Lateral termination - Scale 1:2

Bauanschlüsse
Junction to structure

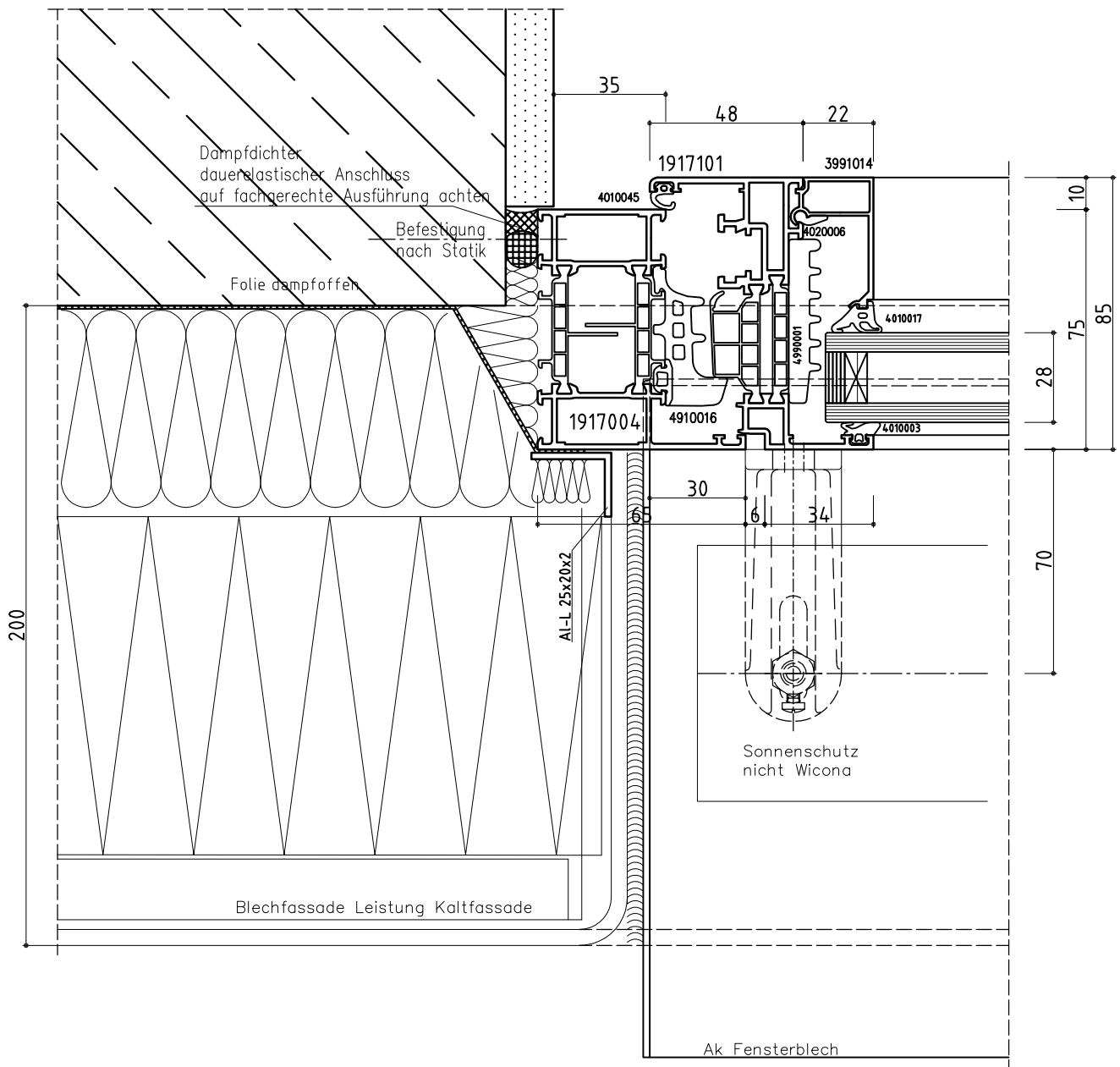
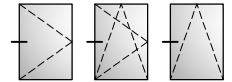

Der dargestellte Bauanschluss ist bauphysikalisch zu überprüfen.
The shown junction to the structure, has to be checked concerning the construction physics.

WICONA®

WICLINE 75

Bauanschluss seitlich - Maßstab 1:2

Lateral termination - Scale 1:2

Bauanschlüsse
Junction to structure

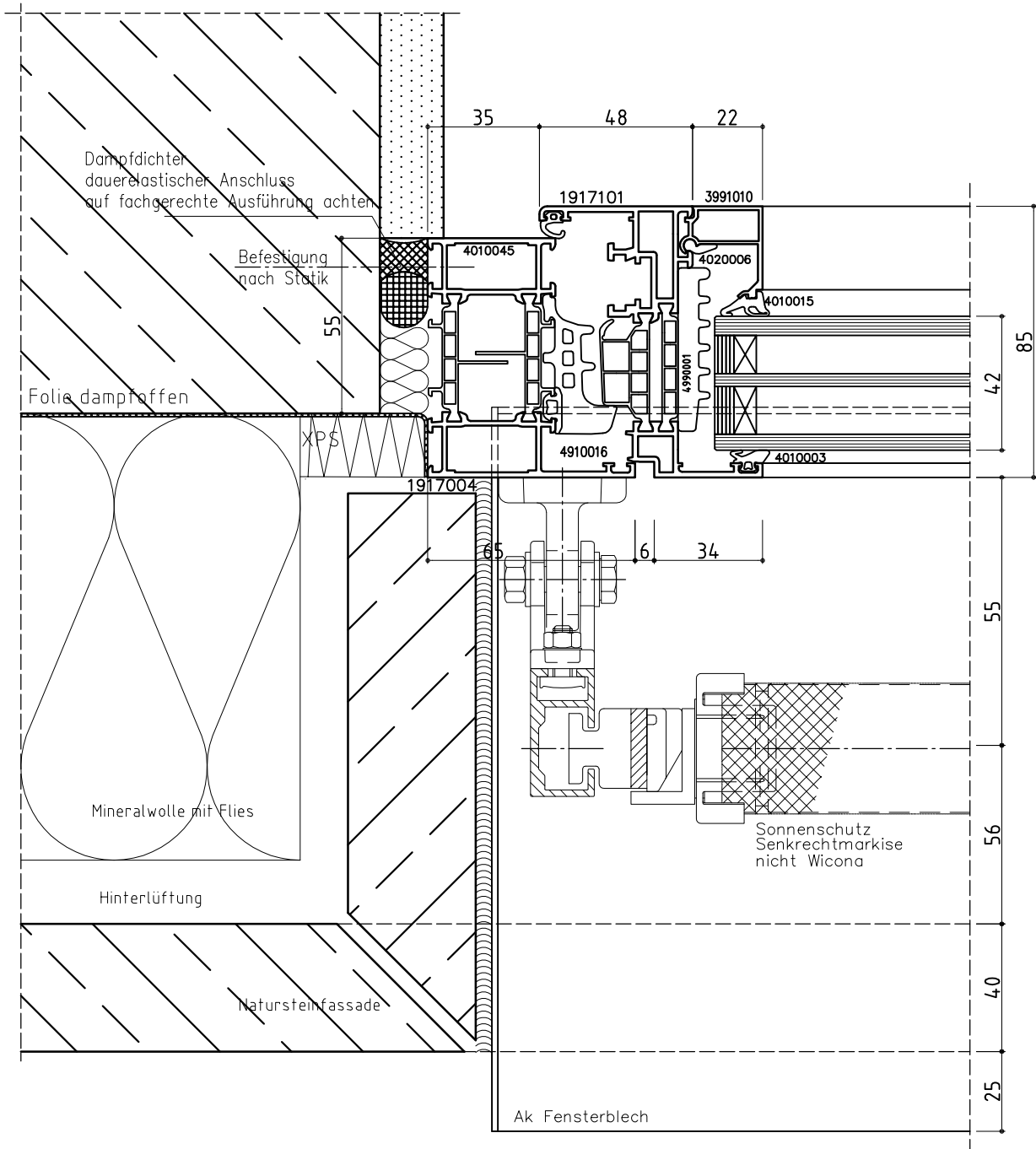
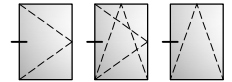

Der dargestellte Bauanschluss ist bauphysikalisch zu überprüfen.

The shown junction to the structure, has to be checked concerning the construction physics.

WICLINE 75

Bauanschlüsse
Junction to structure

Bauanschluss seitlich - Maßstab 1:2

Lateral termination - Scale 1:2

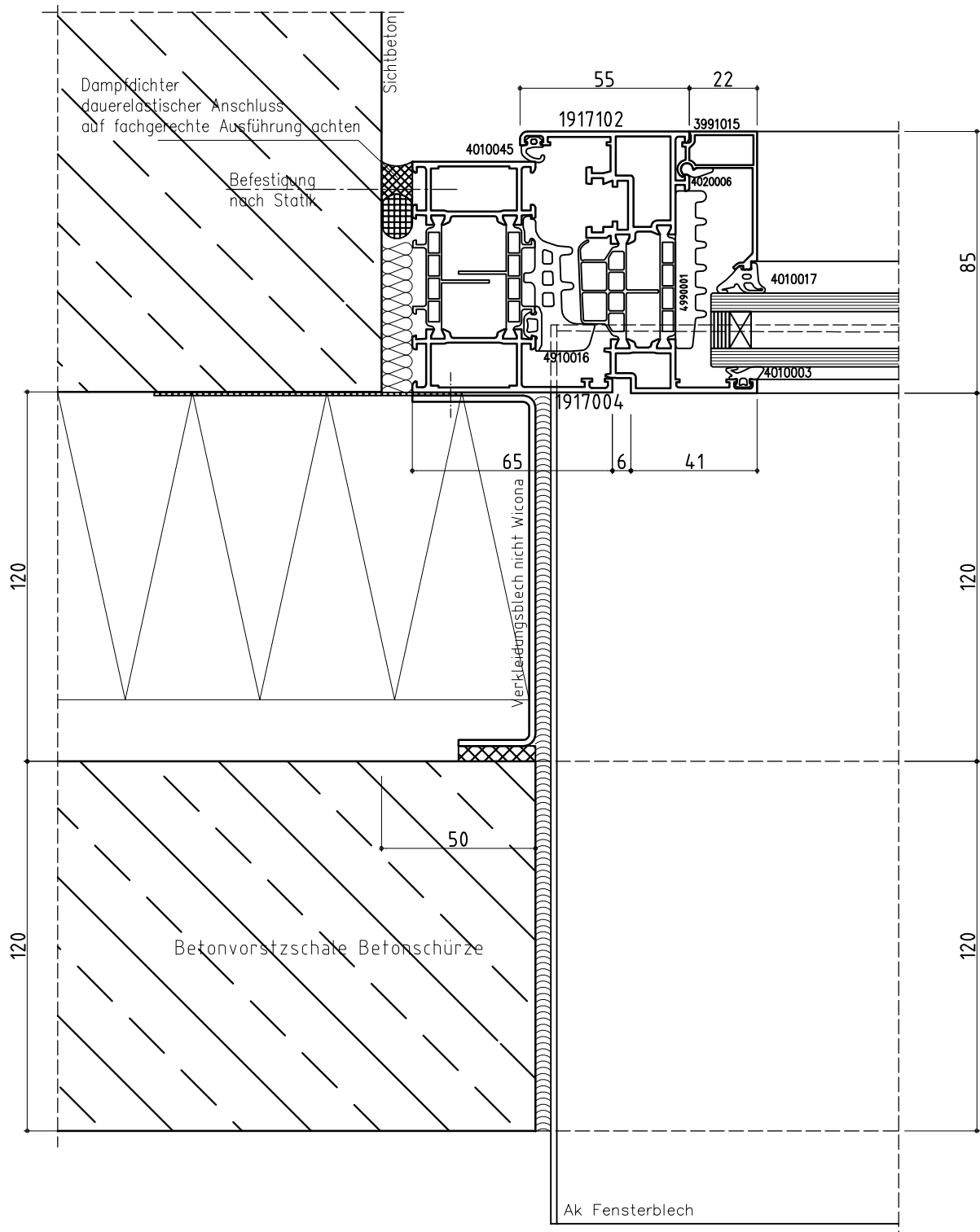
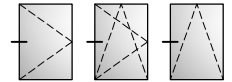

Der dargestellte Bauanschluss ist bauphysikalisch zu überprüfen.
The shown junction to the structure, has to be checked concerning the construction physics.

WICONA®

WICLINE 75

Bauanschluss seitlich - Maßstab 1:2

Lateral termination - Scale 1:2

Bauanschlüsse
Junction to structure

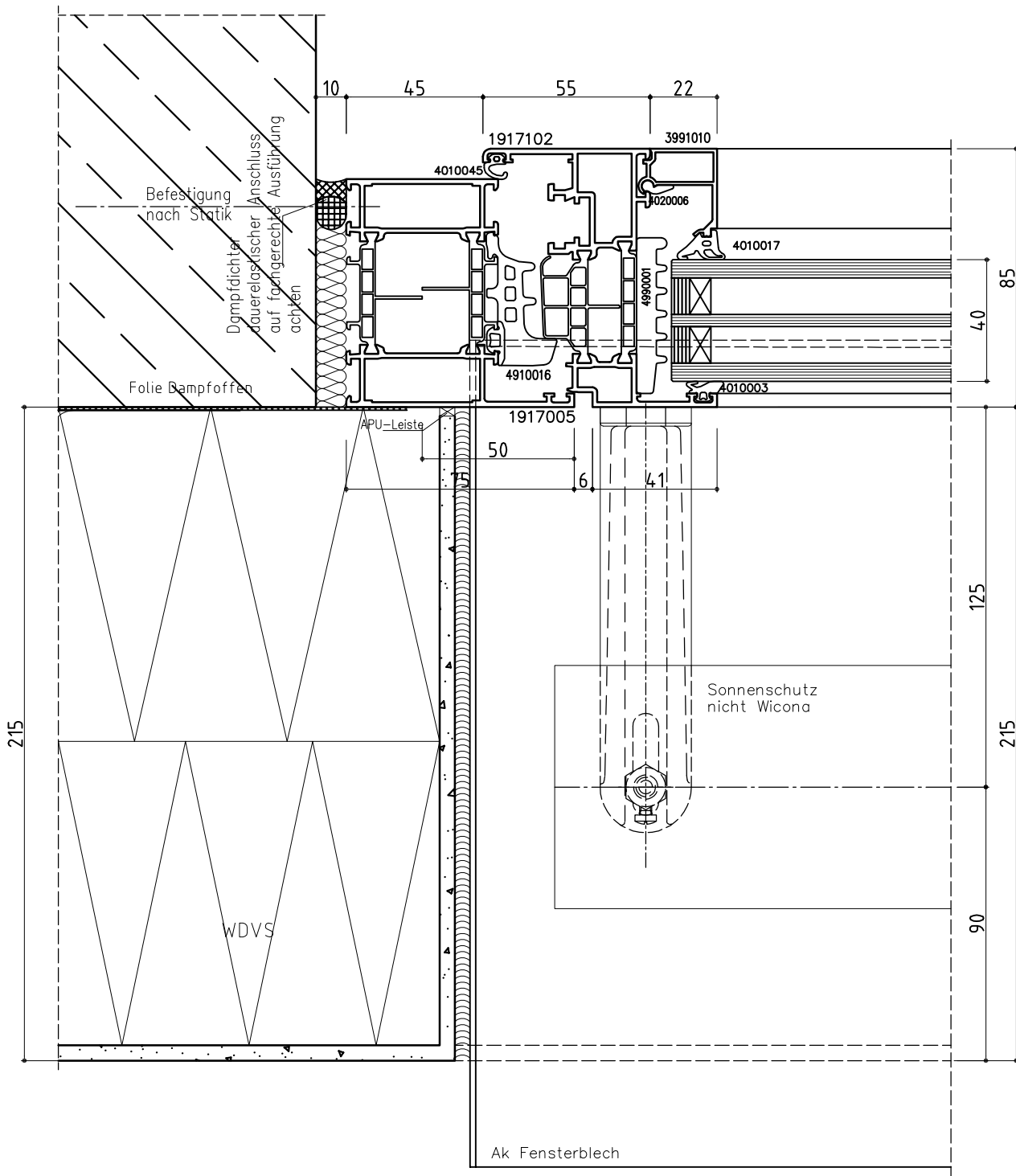
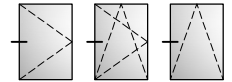

Der dargestellte Bauanschluss ist bauphysikalisch zu überprüfen.
The shown junction to the structure, has to be checked concerning the construction physics.

WICONA®

WICLINE 75

Bauanschluss seitlich - Maßstab 1:2

Lateral termination - Scale 1:2

Bauanschlüsse
Junction to structure

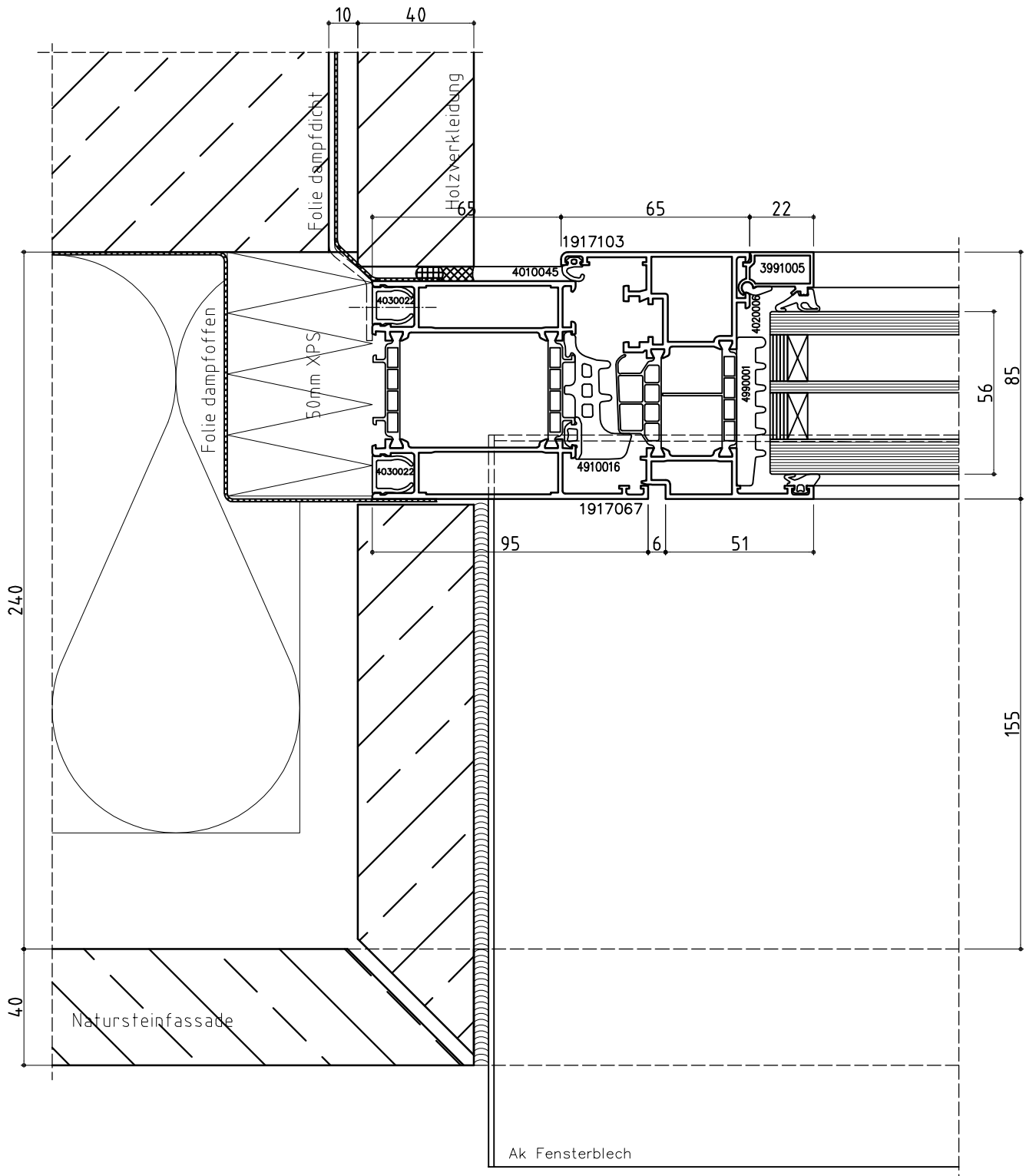
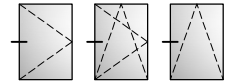

Der dargestellte Bauanschluss ist bauphysikalisch zu überprüfen.
 The shown junction to the structure, has to be checked concerning the construction physics.

WICONA®

WICLINE 75

Bauanschluss seitlich - Maßstab 1:2

Lateral termination - Scale 1:2

Bauanschlüsse
Junction to structure

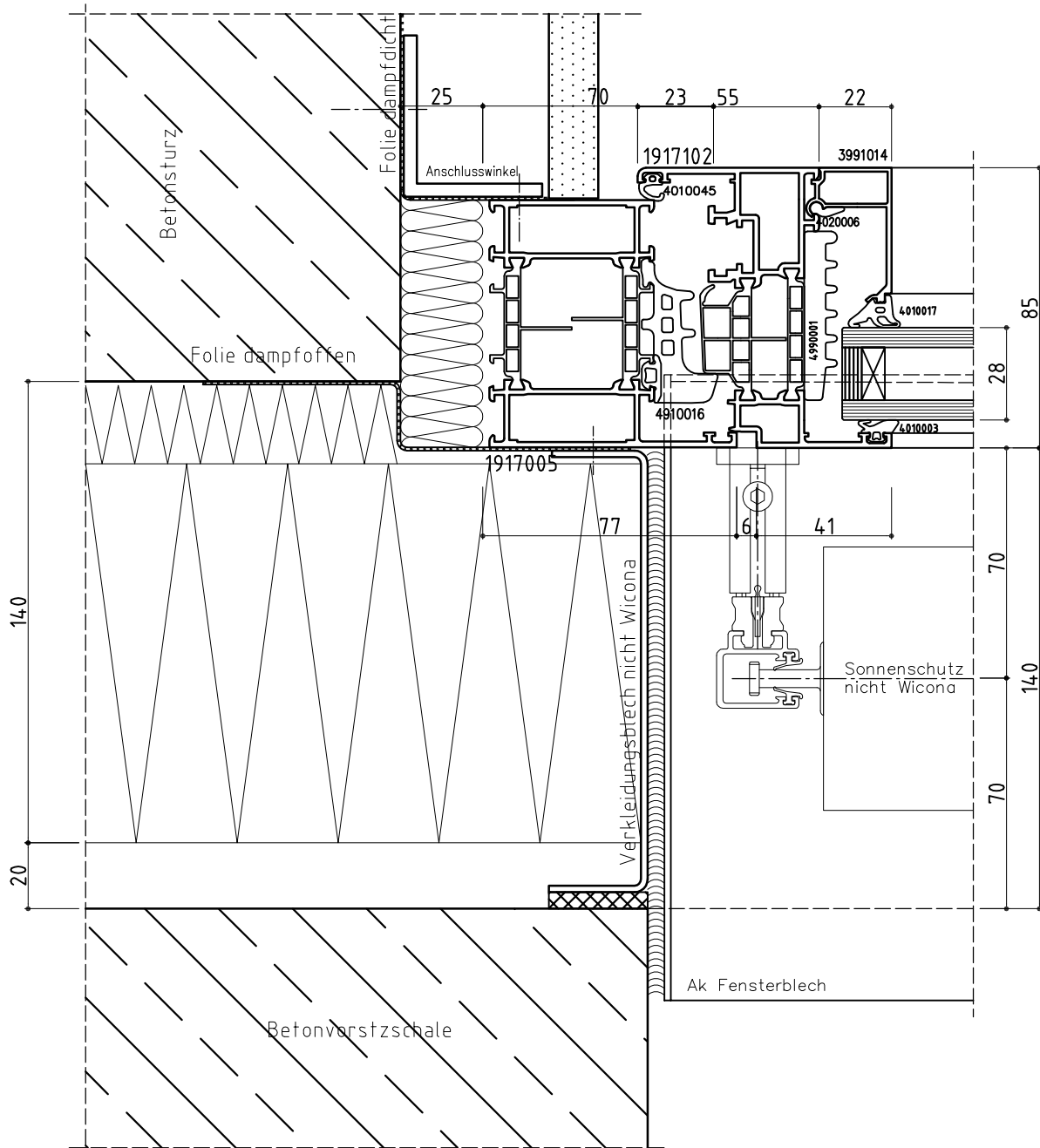
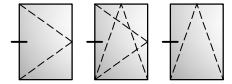

Der dargestellte Bauanschluss ist bauphysikalisch zu überprüfen.
The shown junction to the structure, has to be checked concerning the construction physics.

WICONA®

WICLINE 75

Bauanschluss seitlich - Maßstab 1:2

Lateral termination - Scale 1:2

Bauanschlüsse
Junction to structure

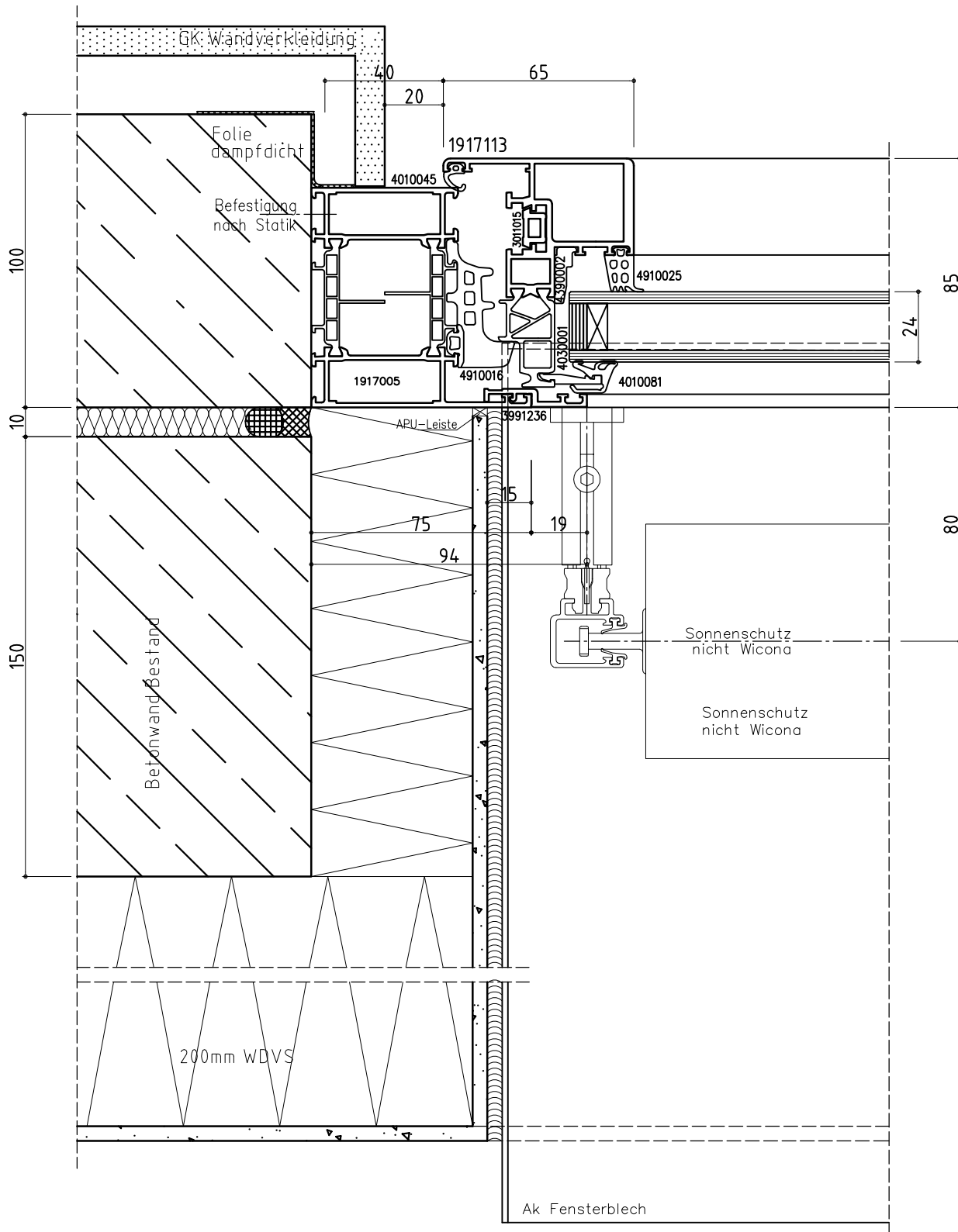
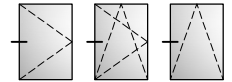

Der dargestellte Bauanschluss ist bauphysikalisch zu überprüfen.
The shown junction to the structure, has to be checked concerning the construction physics.

WICONA®

WICLINE 75

Bauanschluss Zwischenwand - Maßstab 1:2

Partition junction - Scale 1:2

Bauanschlüsse
Junction to structure

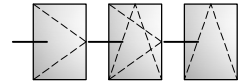

Hinweise zum Konstruktionsvorschlag:

- Es gelten die Verarbeitungsrichtlinien der Wicona-Programme
- Die Dimensionierung der Profile, Verarbeitungsmittel, Verankerungen, Dübel, Schrauben und Verglasungen müssen der statischen Berechnung den gültigen Normen und Vorschriften entsprechen und werden eigenverantwortlich durch die ausführende Firma festgelegt.
- Die dargestellten Bauanschlüsse sind bauphysikalisch zu überprüfen.
- Die fachgerechte Ausführung liegt im Verantwortungsbereich der ausführenden Firma.
- WICONA wird hierfür keine Gewähr übernehmen.

Comments to the Construction offer:

- Processing guidelines, according to the Wicona workshop manuals
- The dimensioning of the profiles, processing means anchors, frame dowels, screws and glasses, has to be done according to the valid standards, regulations and according to the statical calculations. This has to be done self-dependent by the construction company.
- The shown junction to the structure, has to be checked concerning the construction physics.
- The professional workmanship, is in the area of responsibility of the manufacturer.
- Wicona will not give any warranty on this.

WICLINE 75

Bauanschluss Zwischenwand - Maßstab 1:2

Partition junction - Scale 1:2

Bauanschlüsse
Junction to structure

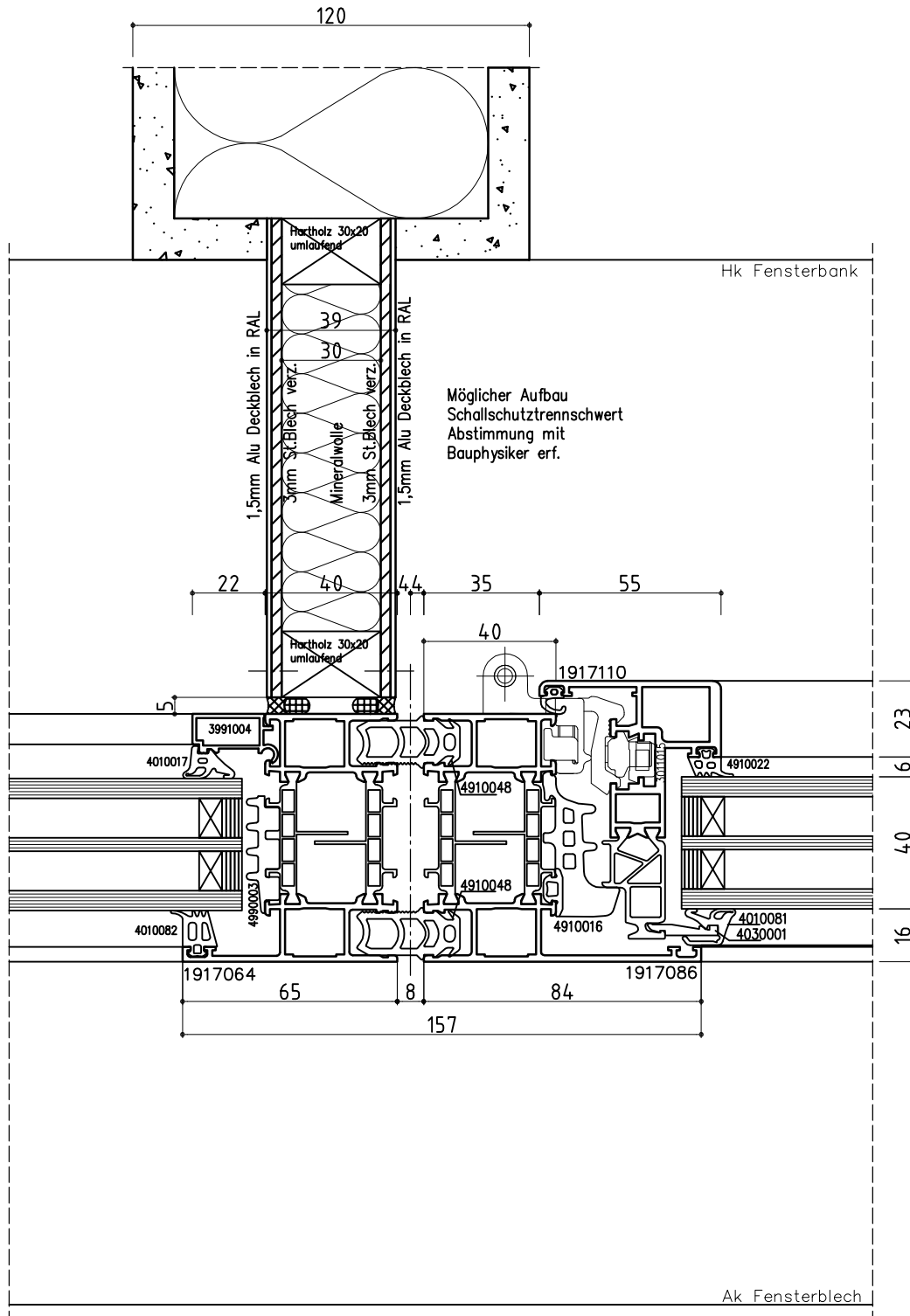
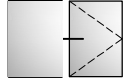

Der dargestellte Bauanschluss ist bauphysikalisch zu überprüfen.
The shown junction to the structure, has to be checked concerning the construction physics.

WICONA®

WICLINE 75

Bauanschluss Zwischenwand - Maßstab 1:2

Partition junction - Scale 1:2

Bauanschlüsse
Junction to structure

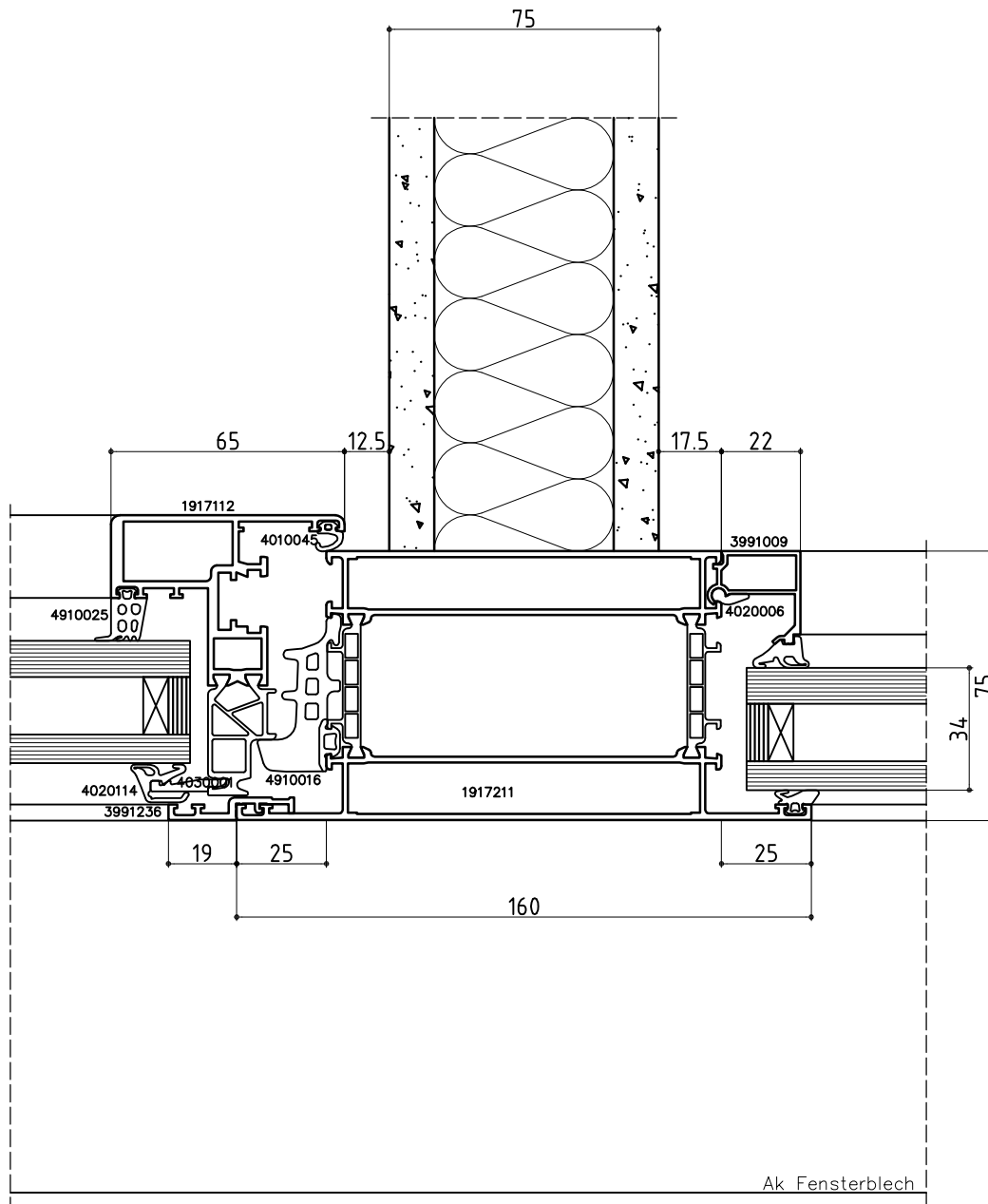
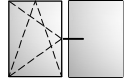

Der dargestellte Bauanschluss ist bauphysikalisch zu überprüfen.
The shown junction to the structure, has to be checked concerning the construction physics.

WICONA®

WICLINE 75

Bauanschluss Zwischenwand - Maßstab 1:2

Partition junction - Scale 1:2

Bauanschlüsse
Junction to structure

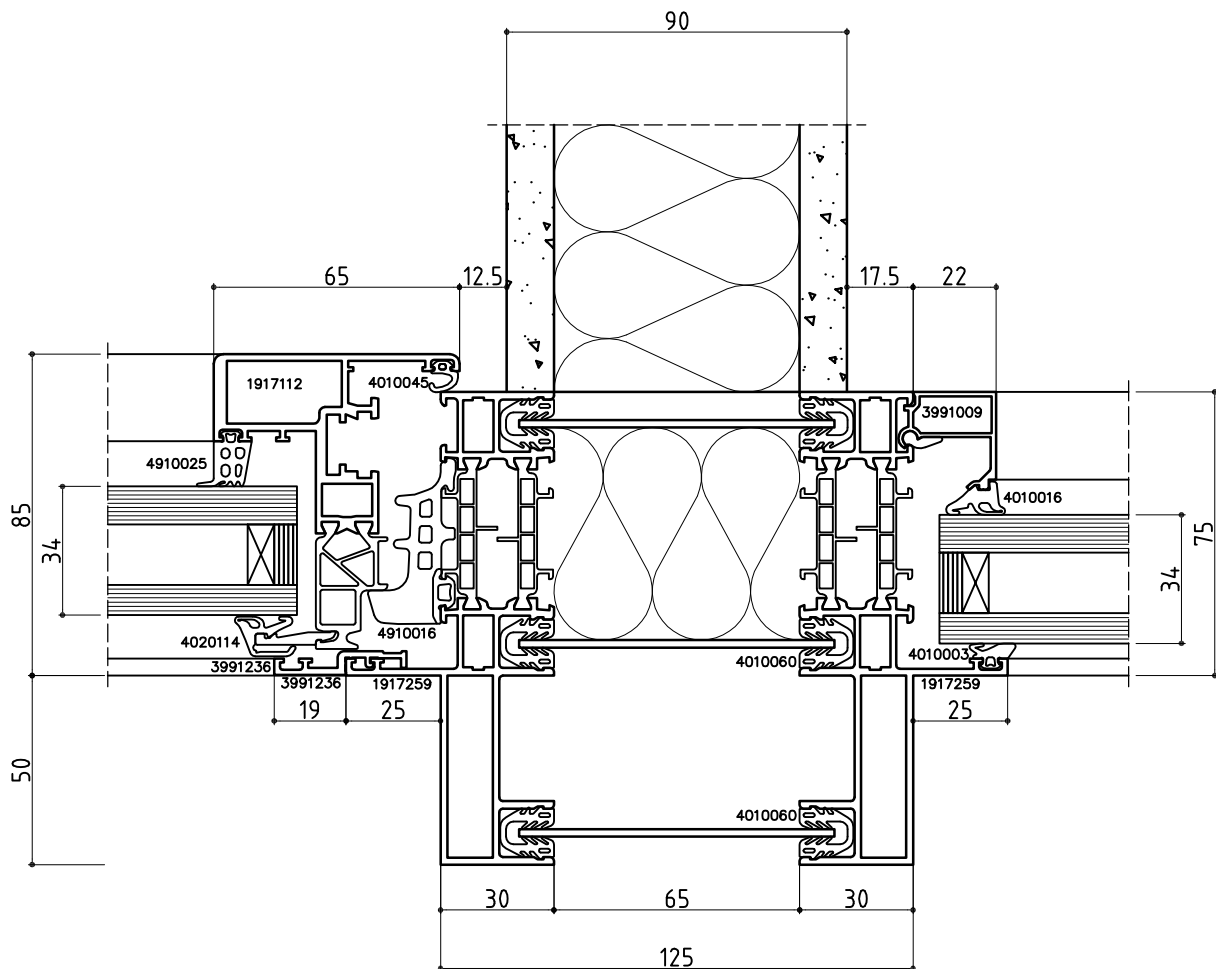
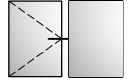

Der dargestellte Bauanschluss ist bauphysikalisch zu überprüfen.
The shown junction to the structure, has to be checked concerning the construction physics.

WICONA®

WICLINE 75

Bauanschluss Zwischenwand - Maßstab 1:2

Partition junction - Scale 1:2

Bauanschlüsse
Junction to structure

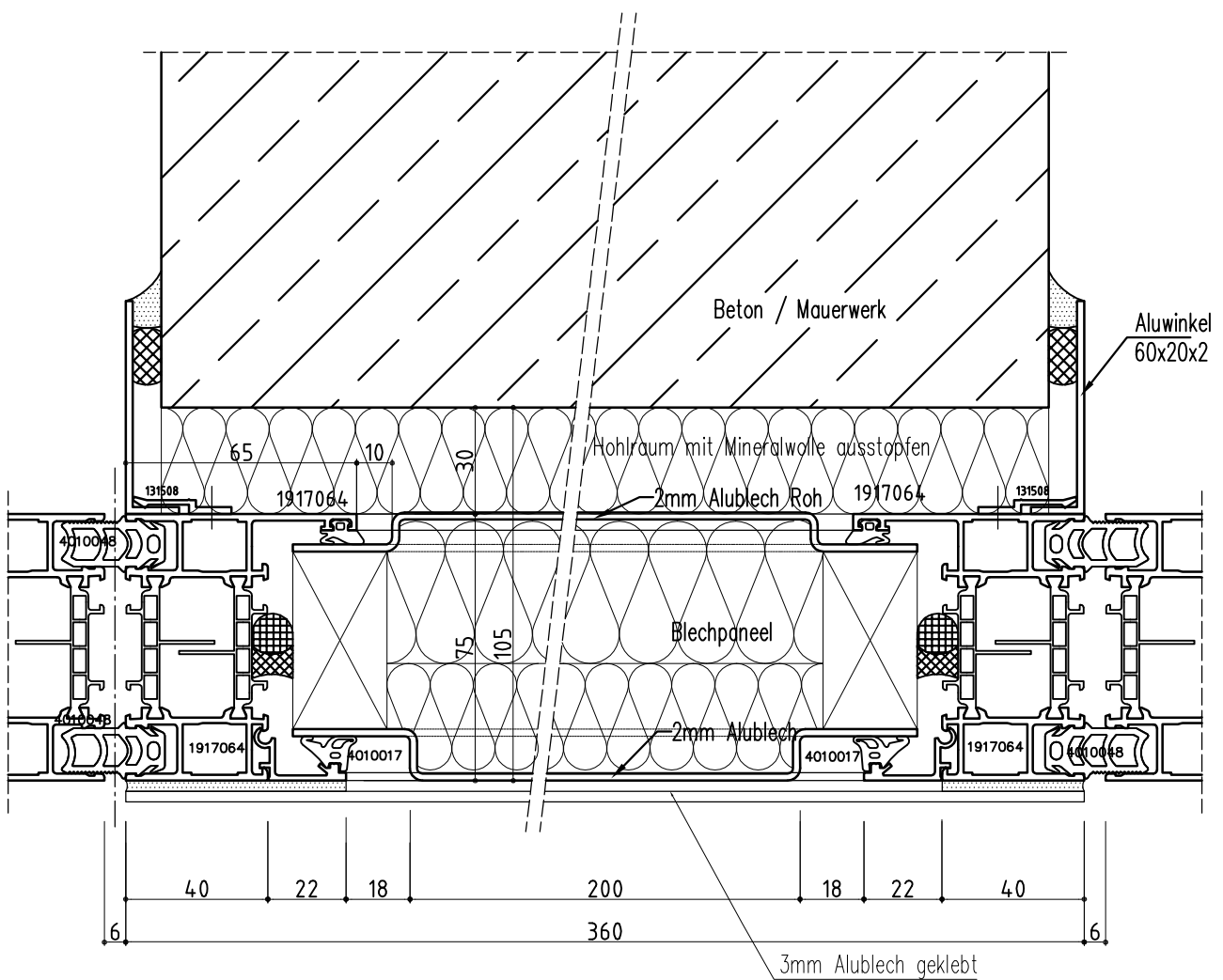
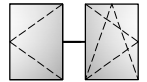

Der dargestellte Bauanschluss ist bauphysikalisch zu überprüfen.

The shown junction to the structure, has to be checked concerning the construction physics.

WICONA®

WICLINE 75

Bauanschluss Zwischenwand - Maßstab 1:2

Partition junction - Scale 1:2

Bauanschlüsse
Junction to structure

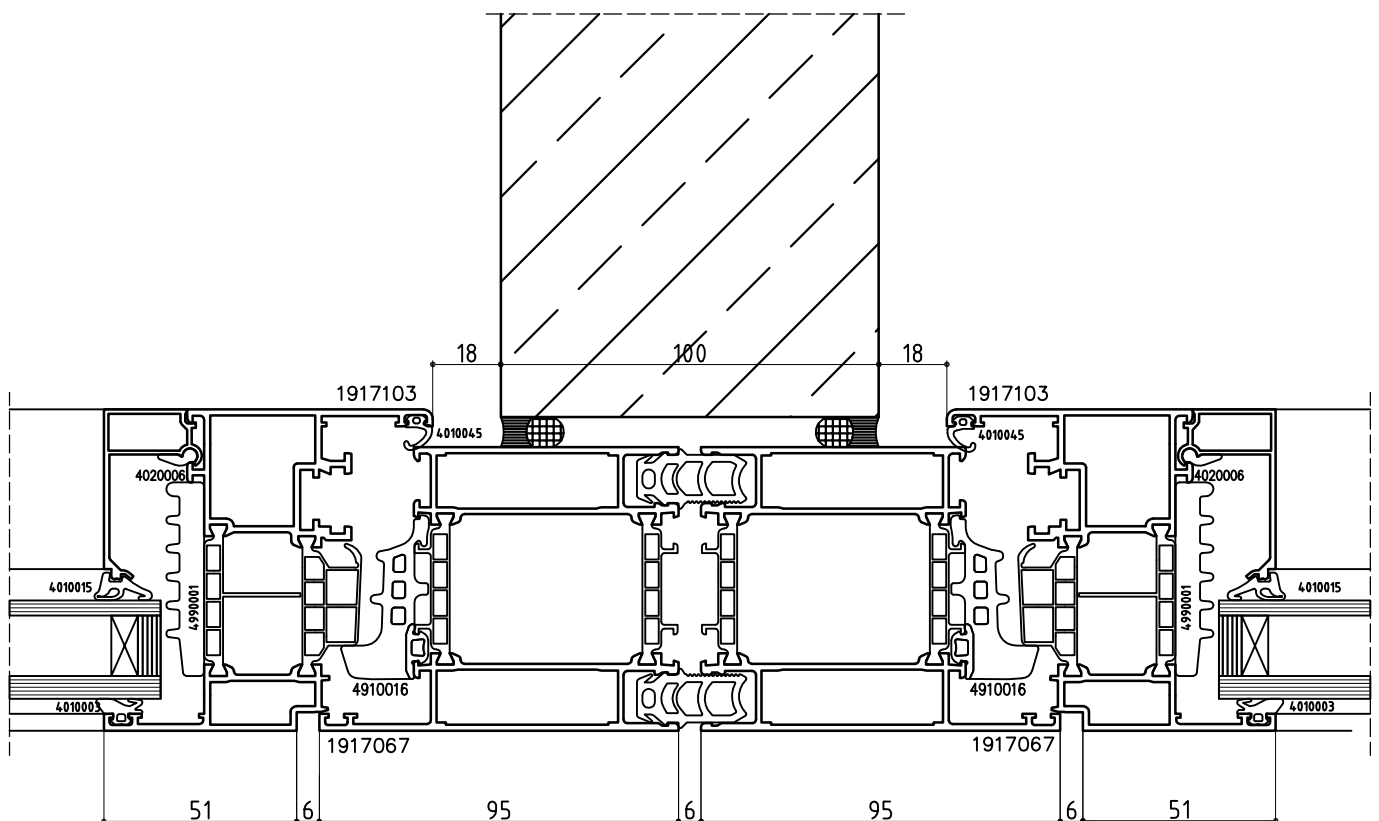
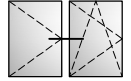

Der dargestellte Bauanschluss ist bauphysikalisch zu überprüfen.
The shown junction to the structure, has to be checked concerning the construction physics.

WICONA®

WICLINE 75

Bauanschluss Zwischenwand - Maßstab 1:2

Partition junction - Scale 1:2

Bauanschlüsse
Junction to structure

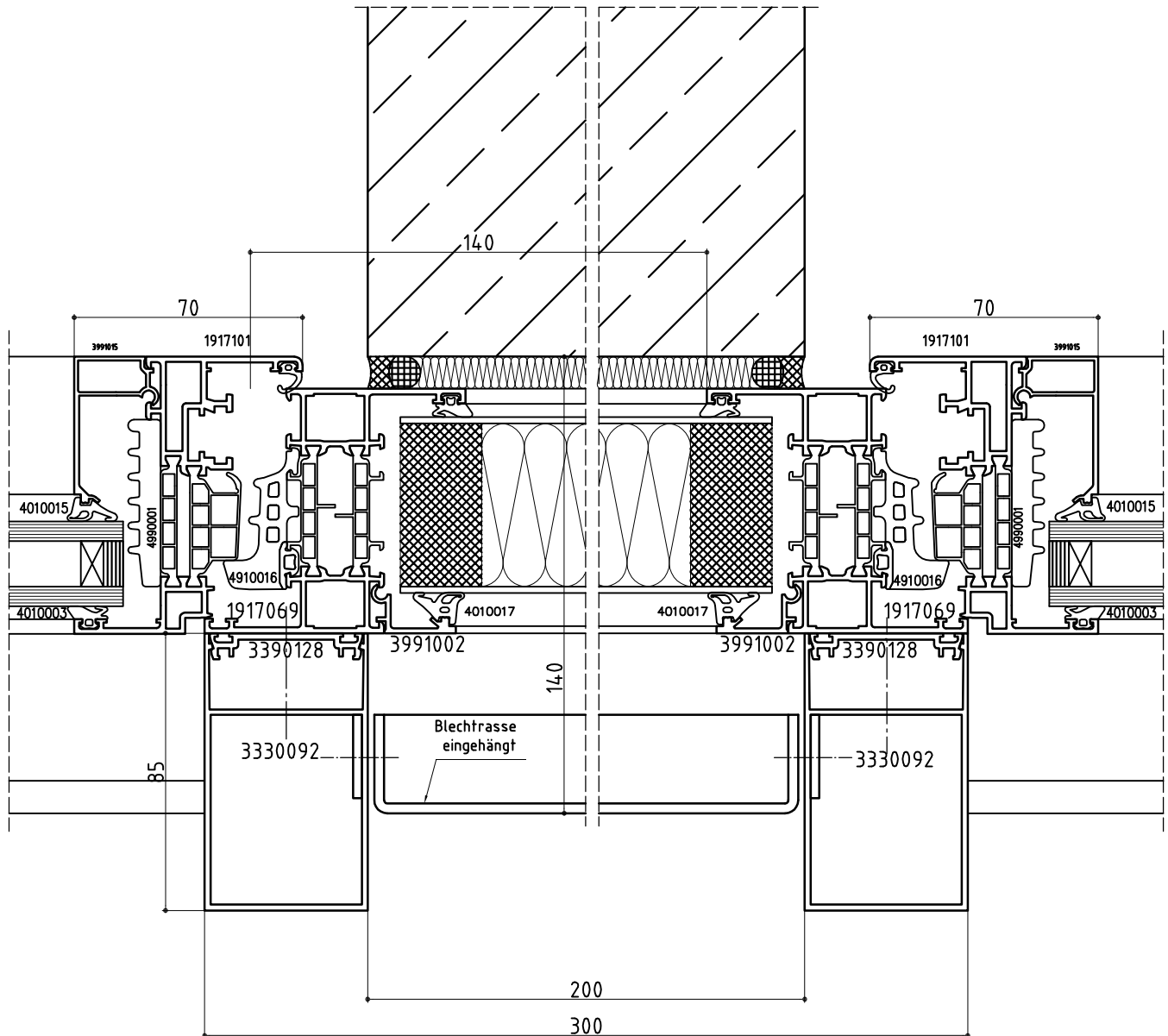
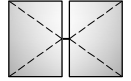

Der dargestellte Bauanschluss ist bauphysikalisch zu überprüfen.
The shown junction to the structure, has to be checked concerning the construction physics.

WICONA®

WICLINE 75

Bauanschluss Zwischenwand - Maßstab 1:2

Partition junction - Scale 1:2

Bauanschlüsse
Junction to structure

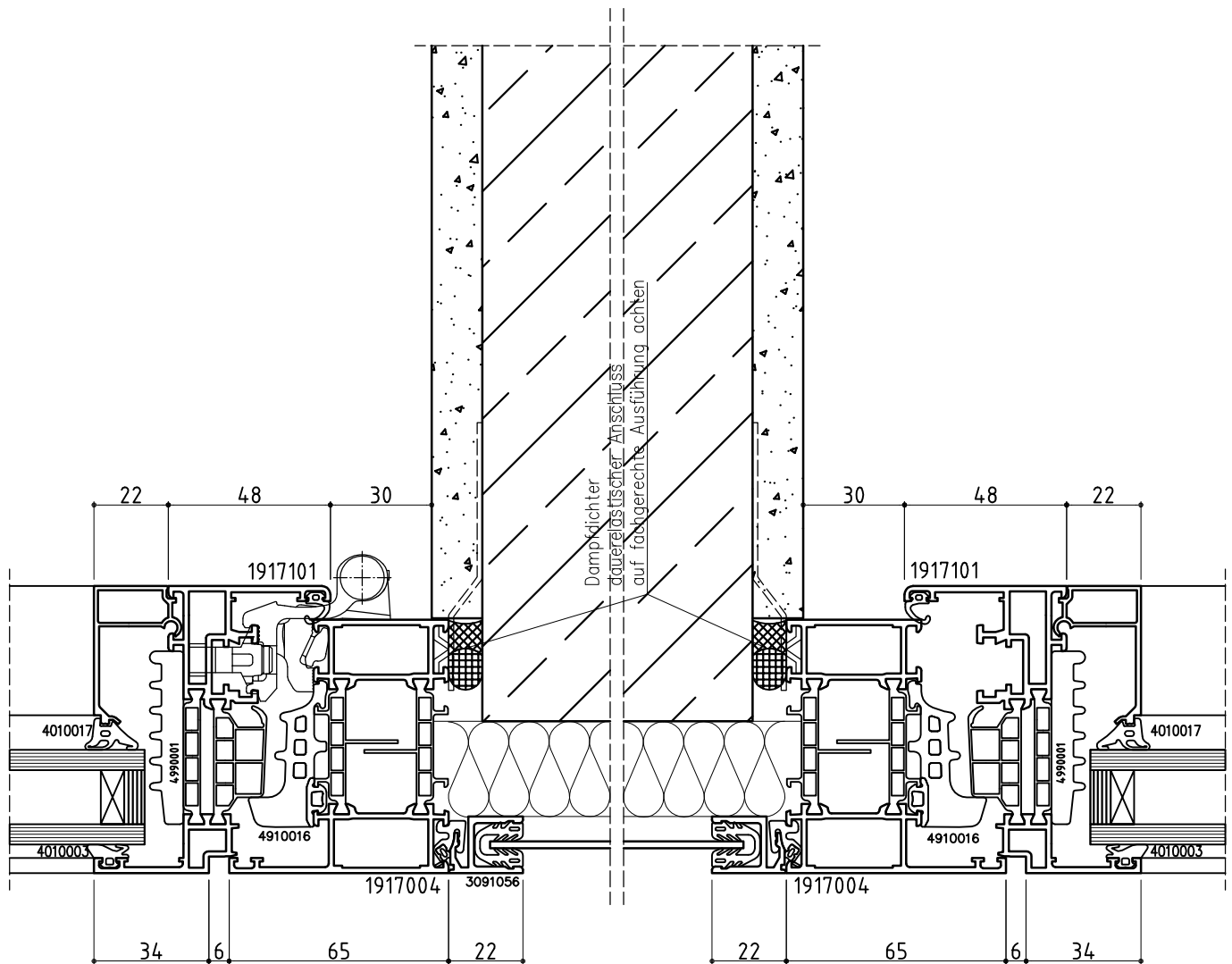
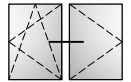

Der dargestellte Bauanschluss ist bauphysikalisch zu überprüfen.
The shown junction to the structure, has to be checked concerning the construction physics.

WICONA®

WICLINE 75

Bauanschluss Zwischenwand - Maßstab 1:2

Partition junction - Scale 1:2

Bauanschlüsse
Junction to structure

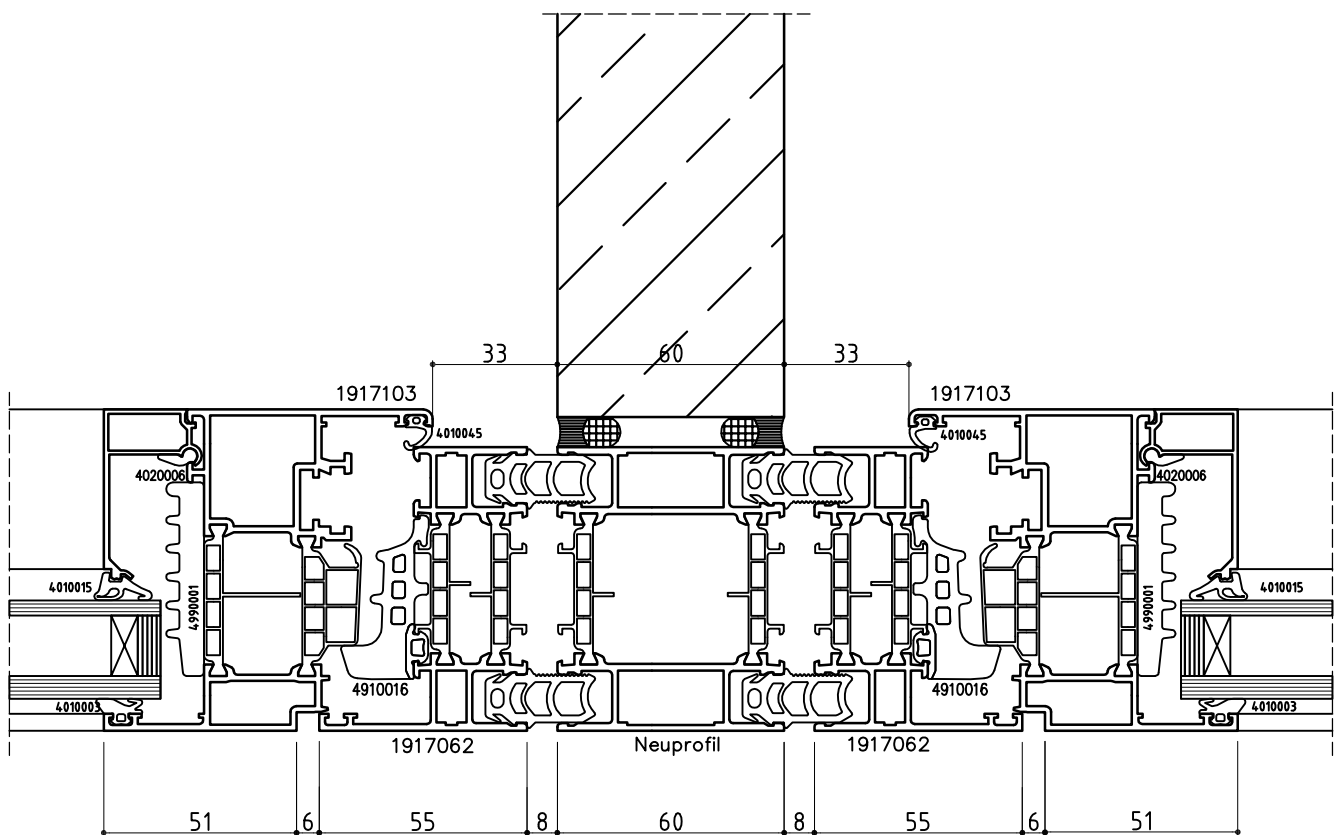
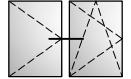

Der dargestellte Bauanschluss ist bauphysikalisch zu überprüfen.
The shown junction to the structure, has to be checked concerning the construction physics.

WICONA®

WICLINE 75

Bauanschluss oben - Maßstab 1:2

Top junction - Scale 1:2

Bauanschlüsse
Junction to structure

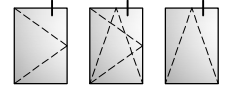

Hinweise zum Konstruktionsvorschlag:

- Es gelten die Verarbeitungsrichtlinien der Wicona-Programme
- Die Dimensionierung der Profile, Verarbeitungsmittel, Verankerungen, Dübel, Schrauben und Verglasungen müssen der statischen Berechnung den gültigen Normen und Vorschriften entsprechen und werden eigenverantwortlich durch die ausführende Firma festgelegt.
- Die dargestellten Bauanschlüsse sind bauphysikalisch zu überprüfen.
- Die fachgerechte Ausführung liegt im Verantwortungsbereich der ausführenden Firma.
- WICONA wird hierfür keine Gewähr übernehmen.

Comments to the Construction offer:

- Processing guidelines, according to the Wicona workshop manuals
- The dimensioning of the profiles, processing means anchors, frame dowels, screws and glasses, has to be done according to the valid standards, regulations and according to the statical calculations. This has to be done self-dependent by the construction company.
- The shown junction to the structure, has to be checked concerning the construction physics.
- The professional workmanship, is in the area of responsibility of the manufacturer.
- Wicona will not give any warranty on this.

WICLINE 75

Bauanschluss oben - Maßstab 1:2

Top junction - Scale 1:2

Bauanschlüsse
Junction to structure

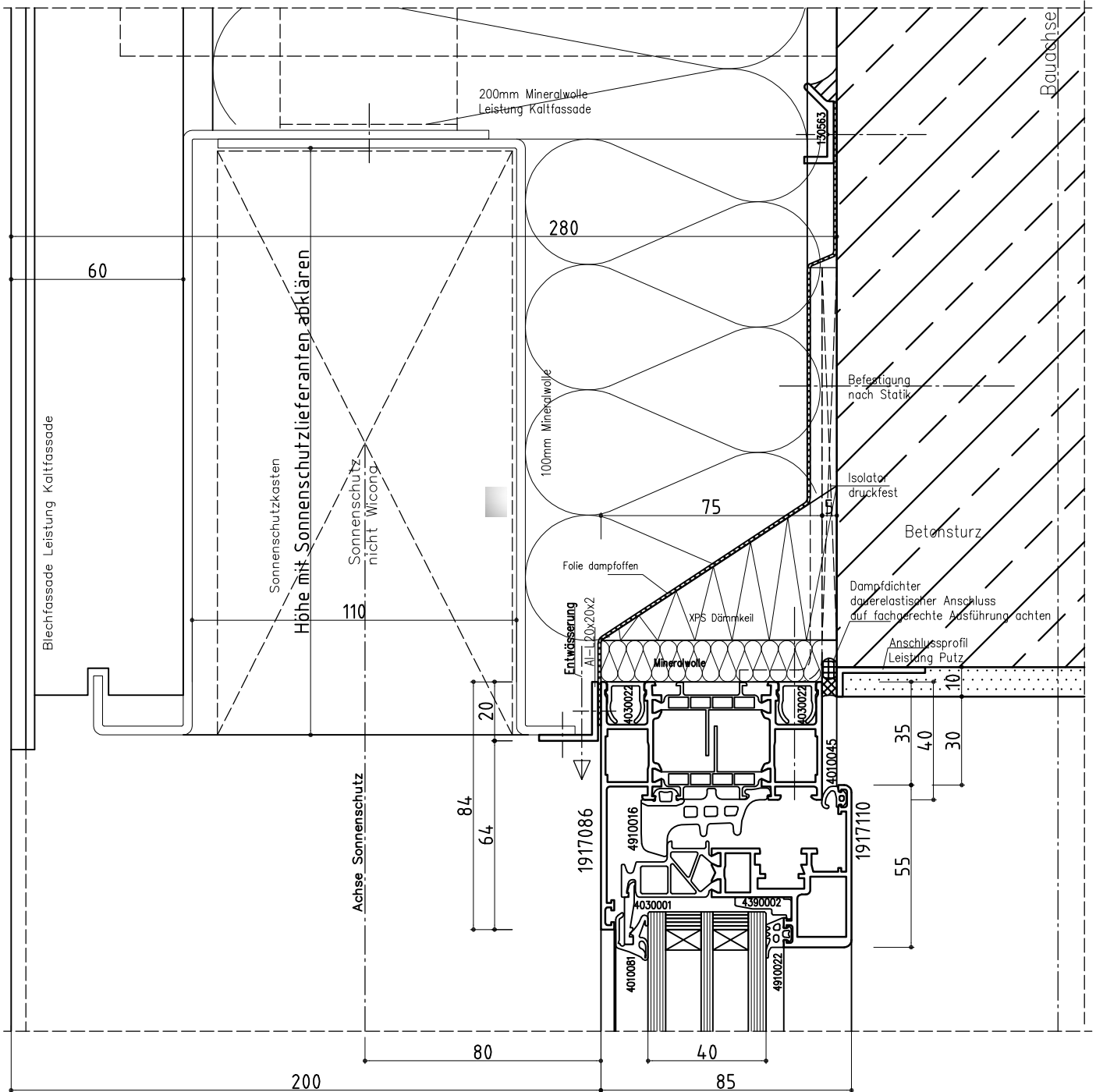

Der dargestellte Bauanschluss ist bauphysikalisch zu überprüfen.
The shown junction to the structure, has to be checked concerning the construction physics.

WICONA®

WICLINE 75

Bauanschluss oben - Maßstab 1:2

Top junction - Scale 1:2

Bauanschlüsse
Junction to structure

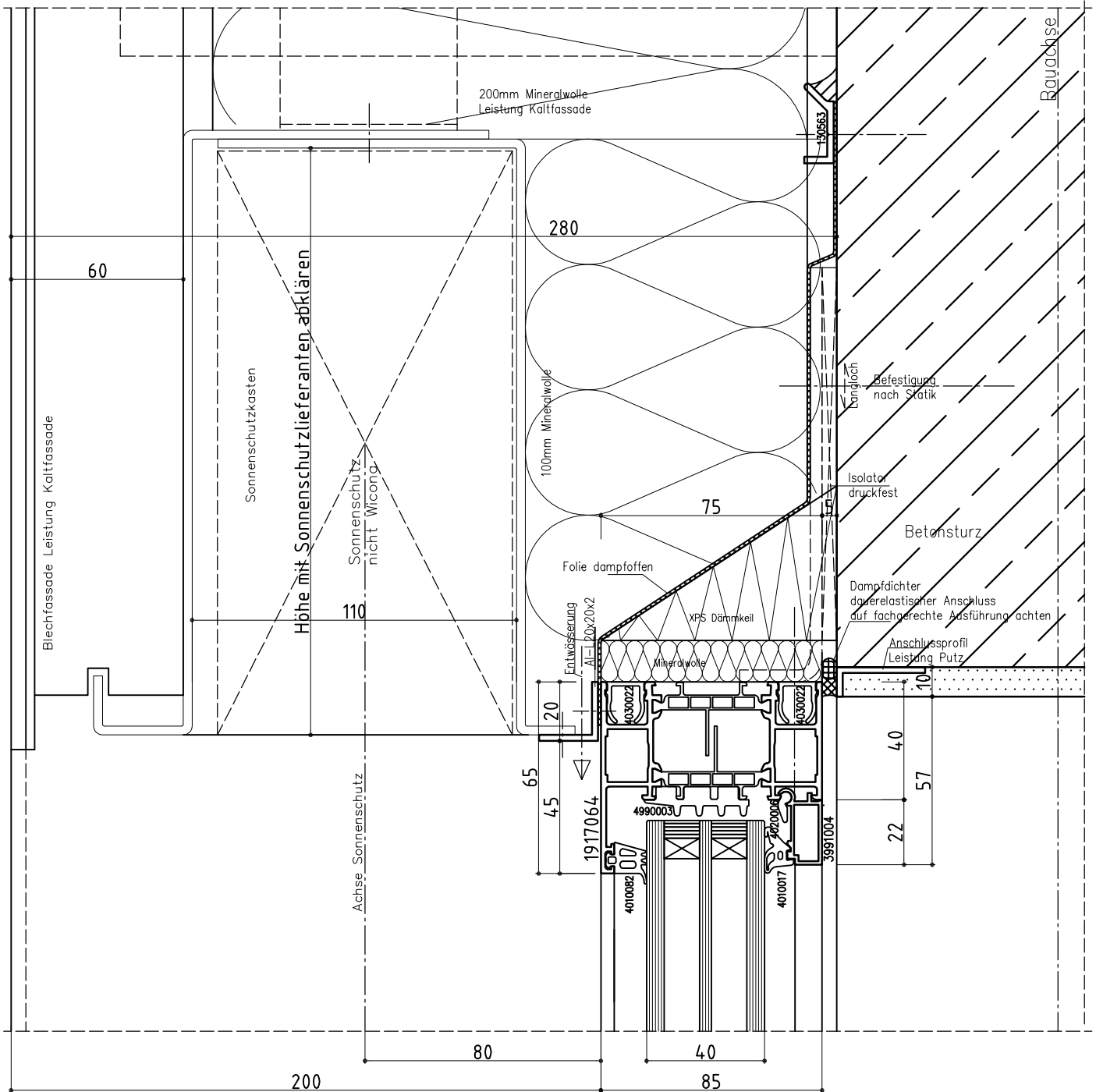

Der dargestellte Bauanschluss ist bauphysikalisch zu überprüfen.
The shown junction to the structure, has to be checked concerning the construction physics.

WICONA®

WICLINE 75

Bauanschluss oben - Maßstab 1:2

Top junction - Scale 1:2

Bauanschlüsse
Junction to structure

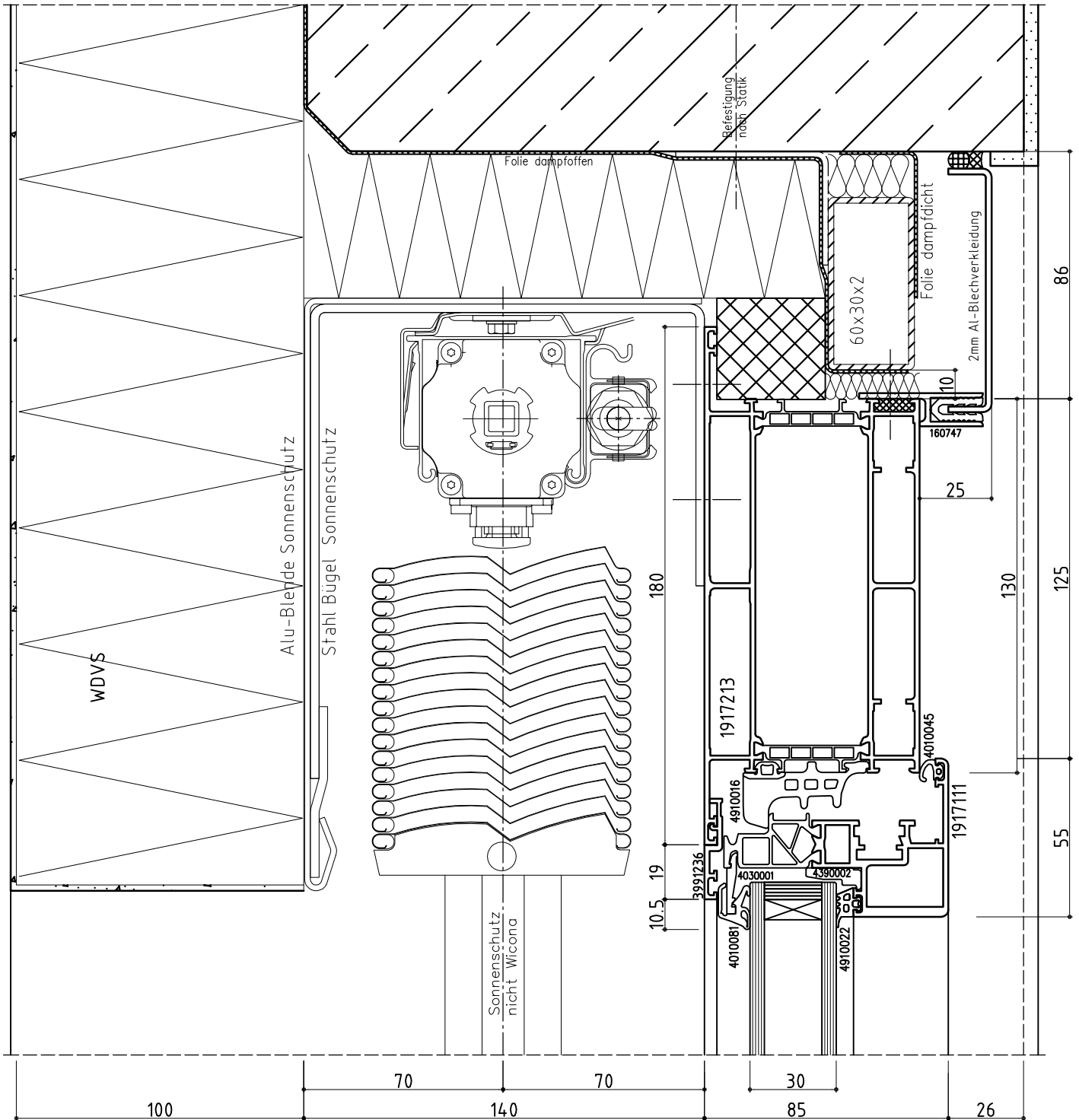
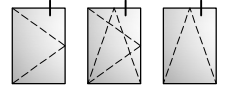

Der dargestellte Bauanschluss ist bauphysikalisch zu überprüfen.
The shown junction to the structure, has to be checked concerning the construction physics.

WICONA®

WICLINE 75

Bauanschluss oben - Maßstab 1:2

Top junction - Scale 1:2

Bauanschlüsse
Junction to structure

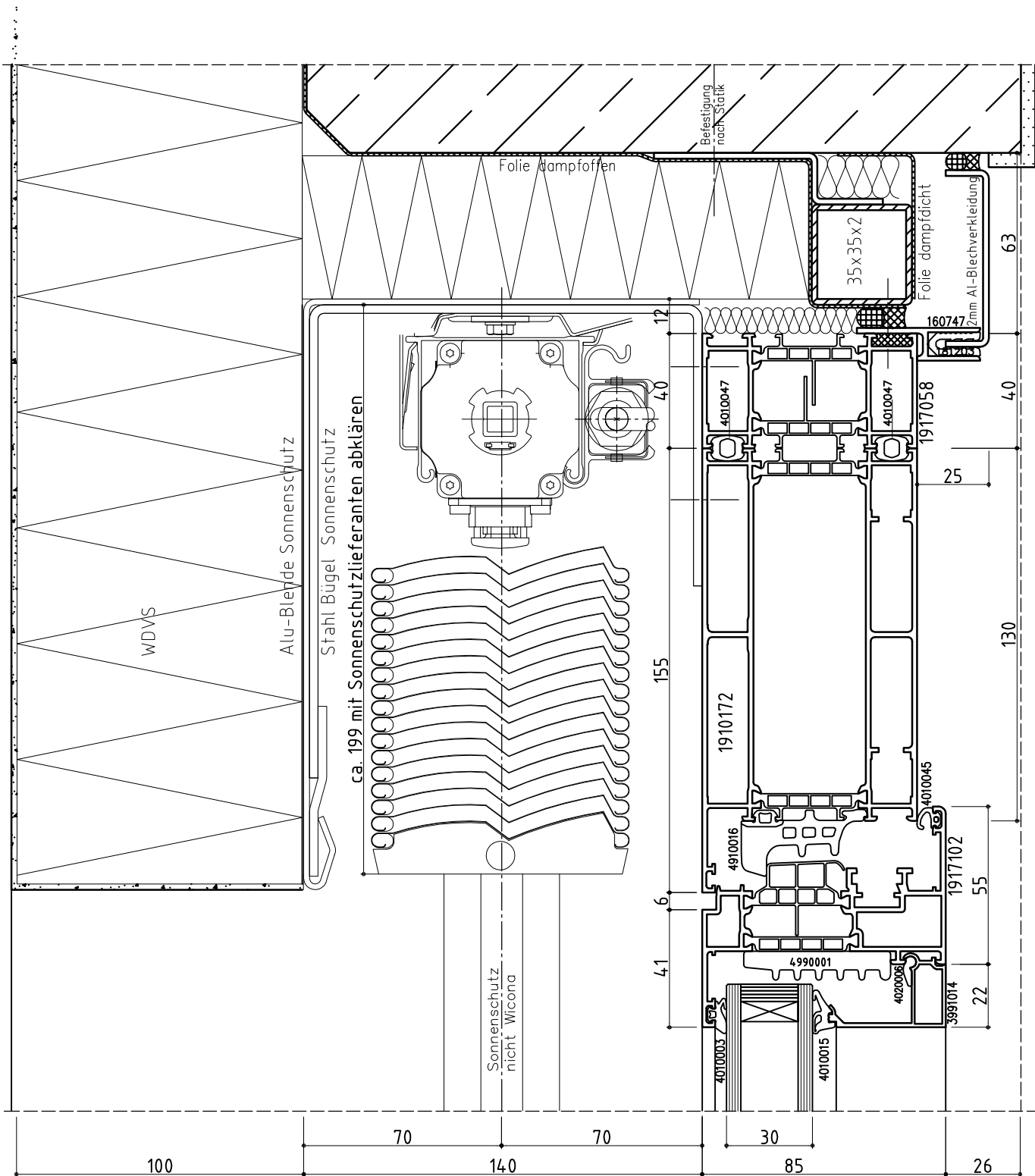
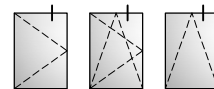

Der dargestellte Bauanschluss ist bauphysikalisch zu überprüfen.
The shown junction to the structure, has to be checked concerning the construction physics.

WICONA®

WICLINE 75

Bauanschluss oben - Maßstab 1:2

Top junction - Scale 1:2

Bauanschlüsse
Junction to structure

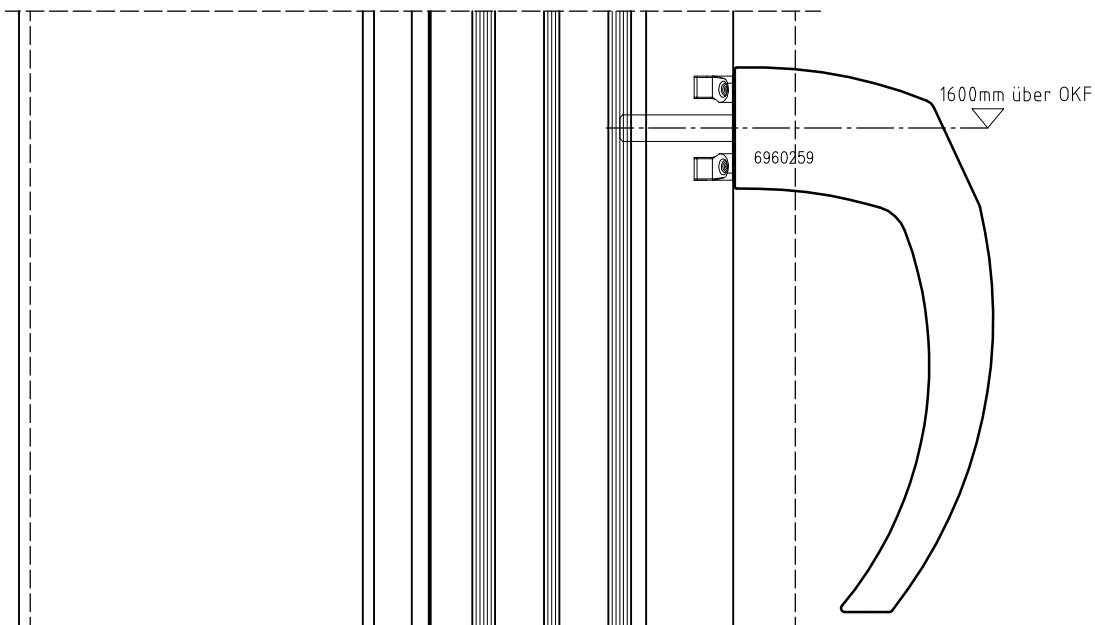
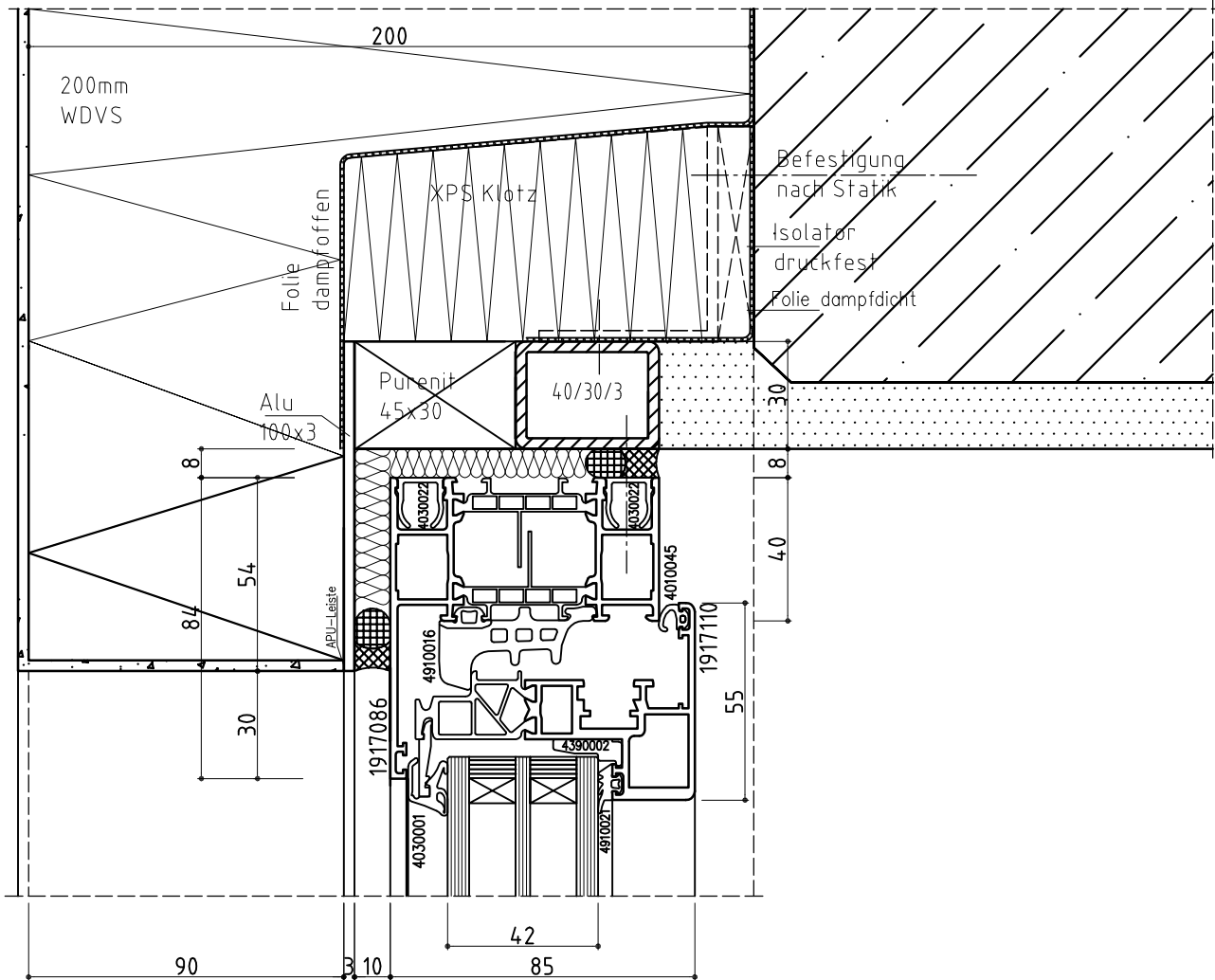
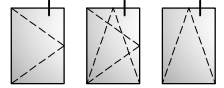

Der dargestellte Bauanschluss ist bauphysikalisch zu überprüfen.
The shown junction to the structure, has to be checked concerning the construction physics.

WICONA®

WICLINE 75

Bauanschluss oben - Maßstab 1:2

Top junction - Scale 1:2

Bauanschlüsse
Junction to structure

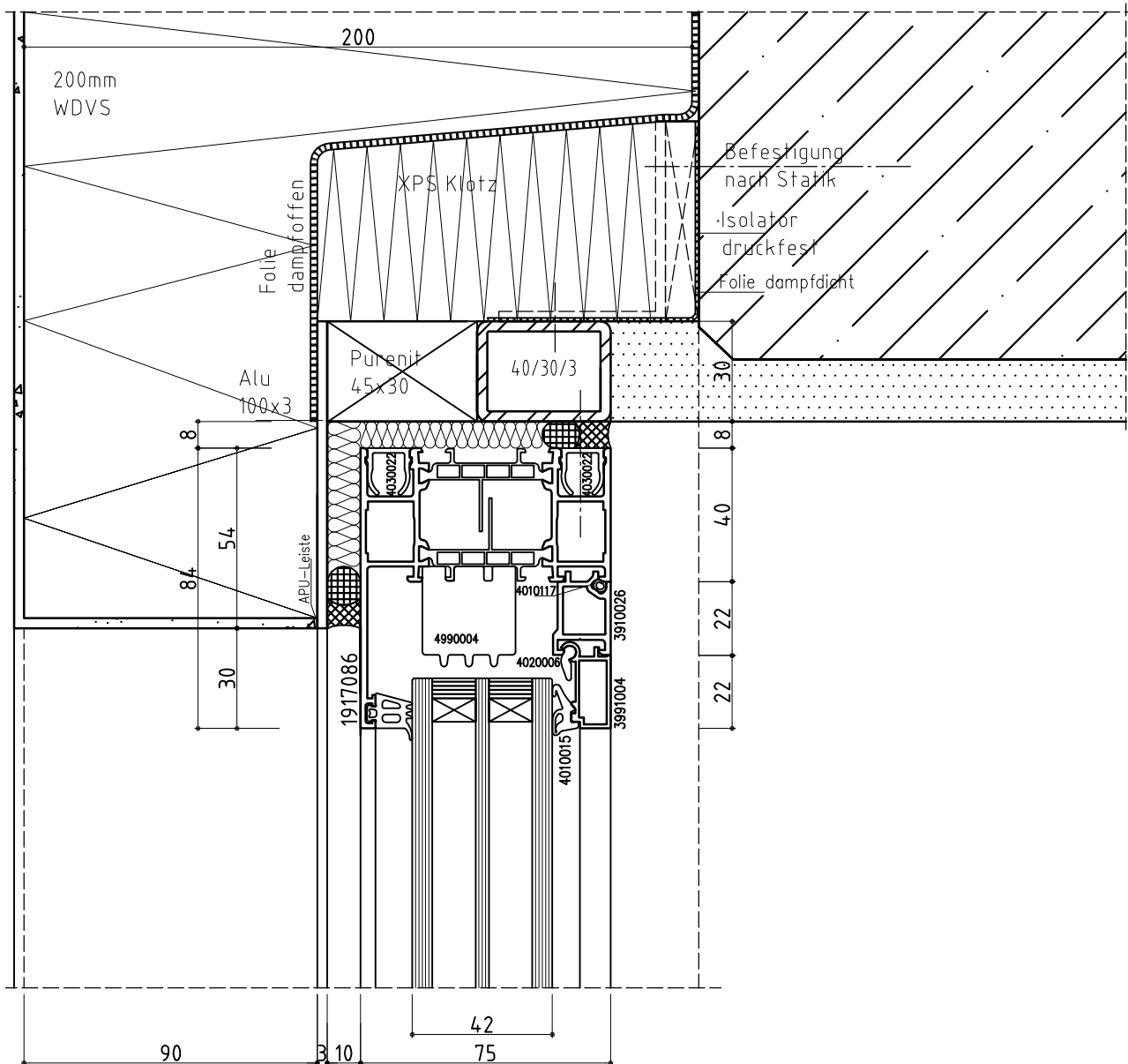

Der dargestellte Bauanschluss ist bauphysikalisch zu überprüfen.
The shown junction to the structure, has to be checked concerning the construction physics.

WICONA®

WICLINE 75

Bauanschluss oben - Maßstab 1:2

Top junction - Scale 1:2

Bauanschlüsse
Junction to structure

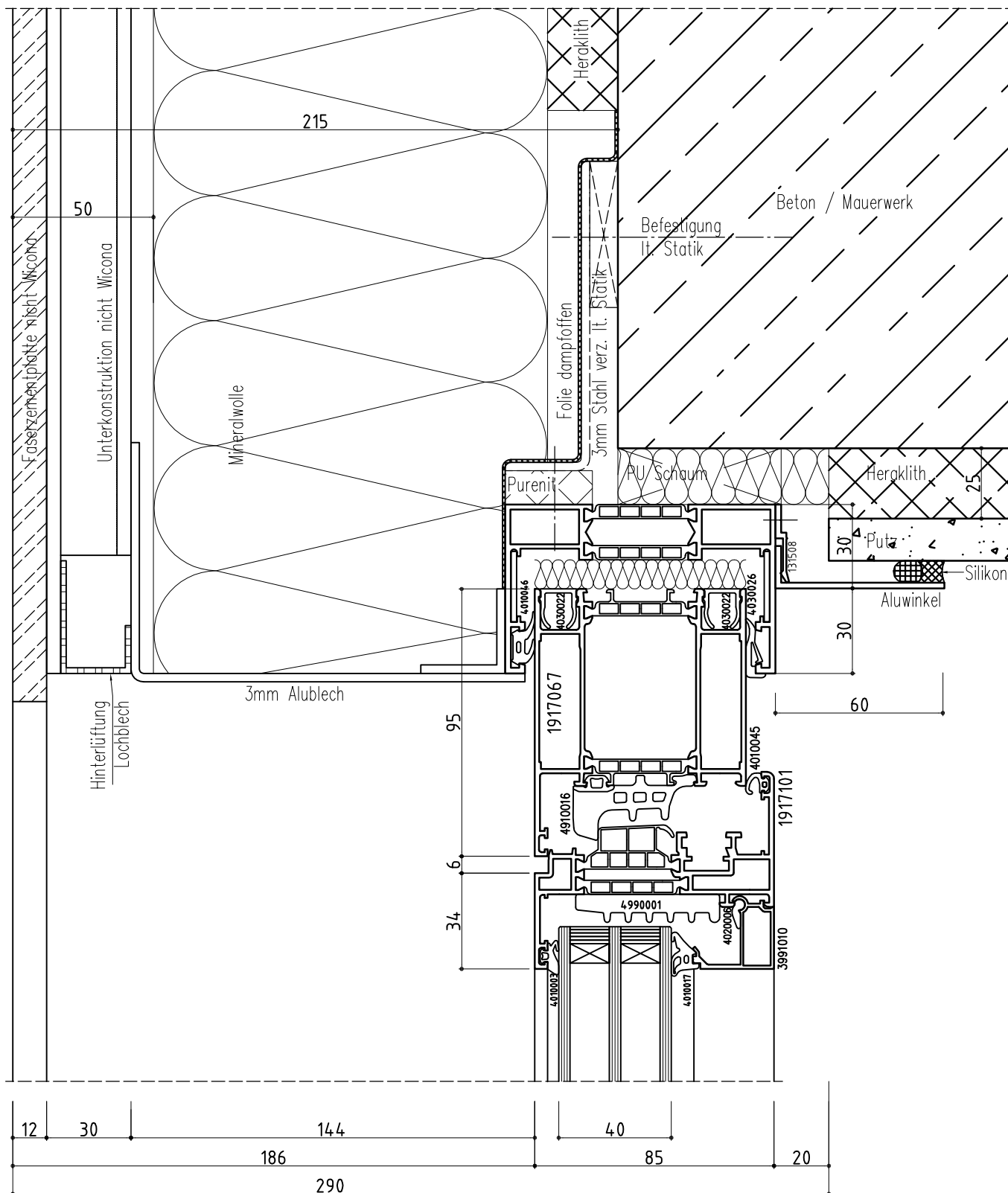
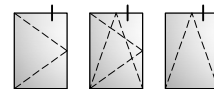

Der dargestellte Bauanschluss ist bauphysikalisch zu überprüfen.
The shown junction to the structure, has to be checked concerning the construction physics.

WICONA®

WICLINE 75

Bauanschluss oben - Maßstab 1:2

Top junction - Scale 1:2

Bauanschlüsse
Junction to structure

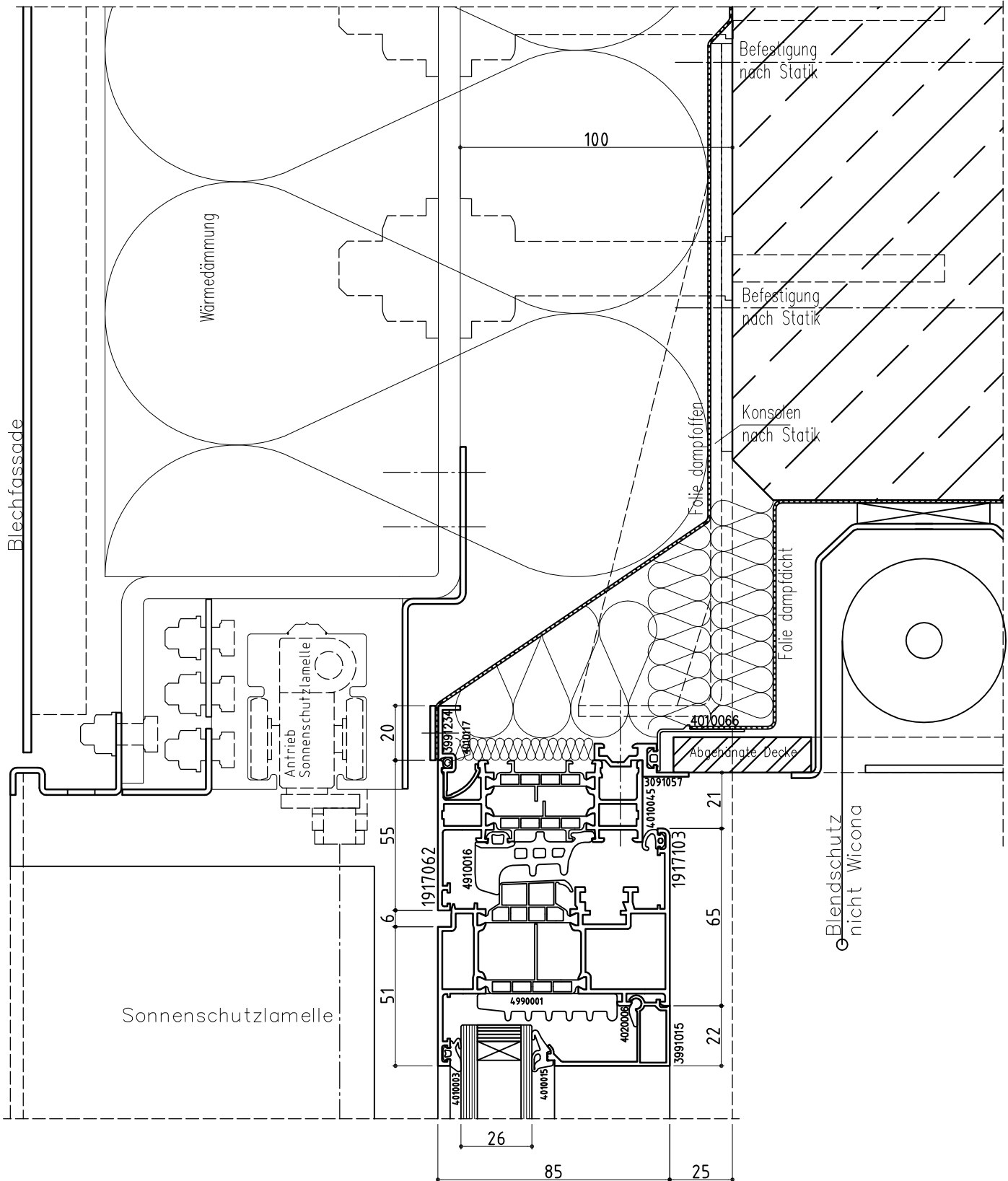

Der dargestellte Bauanschluss ist bauphysikalisch zu überprüfen.
The shown junction to the structure, has to be checked concerning the construction physics.

WICONA®

WICLINE 75

Bauanschluss oben - Maßstab 1:2

Top junction - Scale 1:2

Bauanschlüsse
Junction to structure

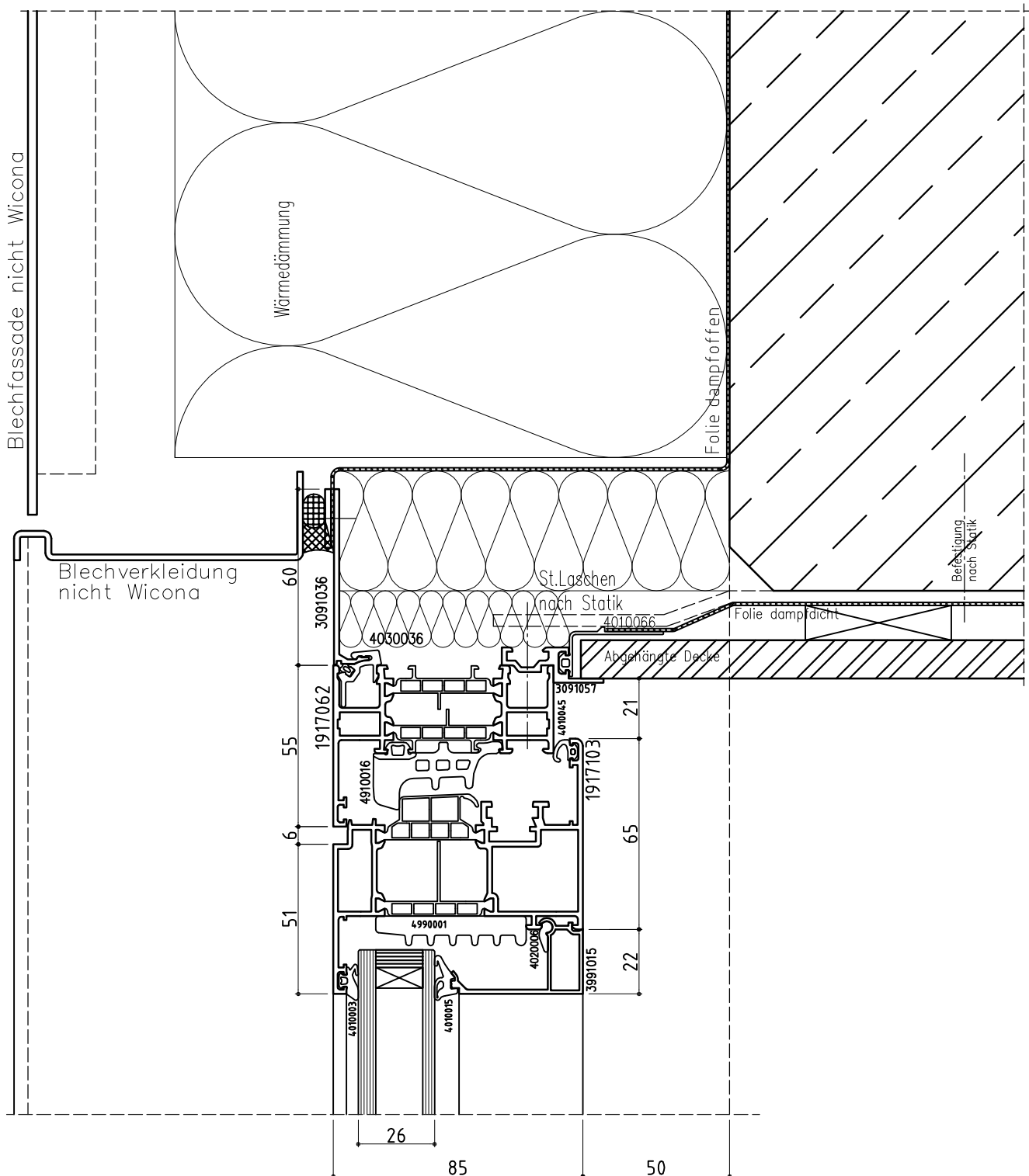
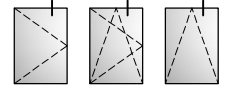

Der dargestellte Bauanschluss ist bauphysikalisch zu überprüfen.
The shown junction to the structure, has to be checked concerning the construction physics.

WICLINE 75

Bauanschluss oben - Maßstab 1:2

Top junction - Scale 1:2

Bauanschlüsse
Junction to structure

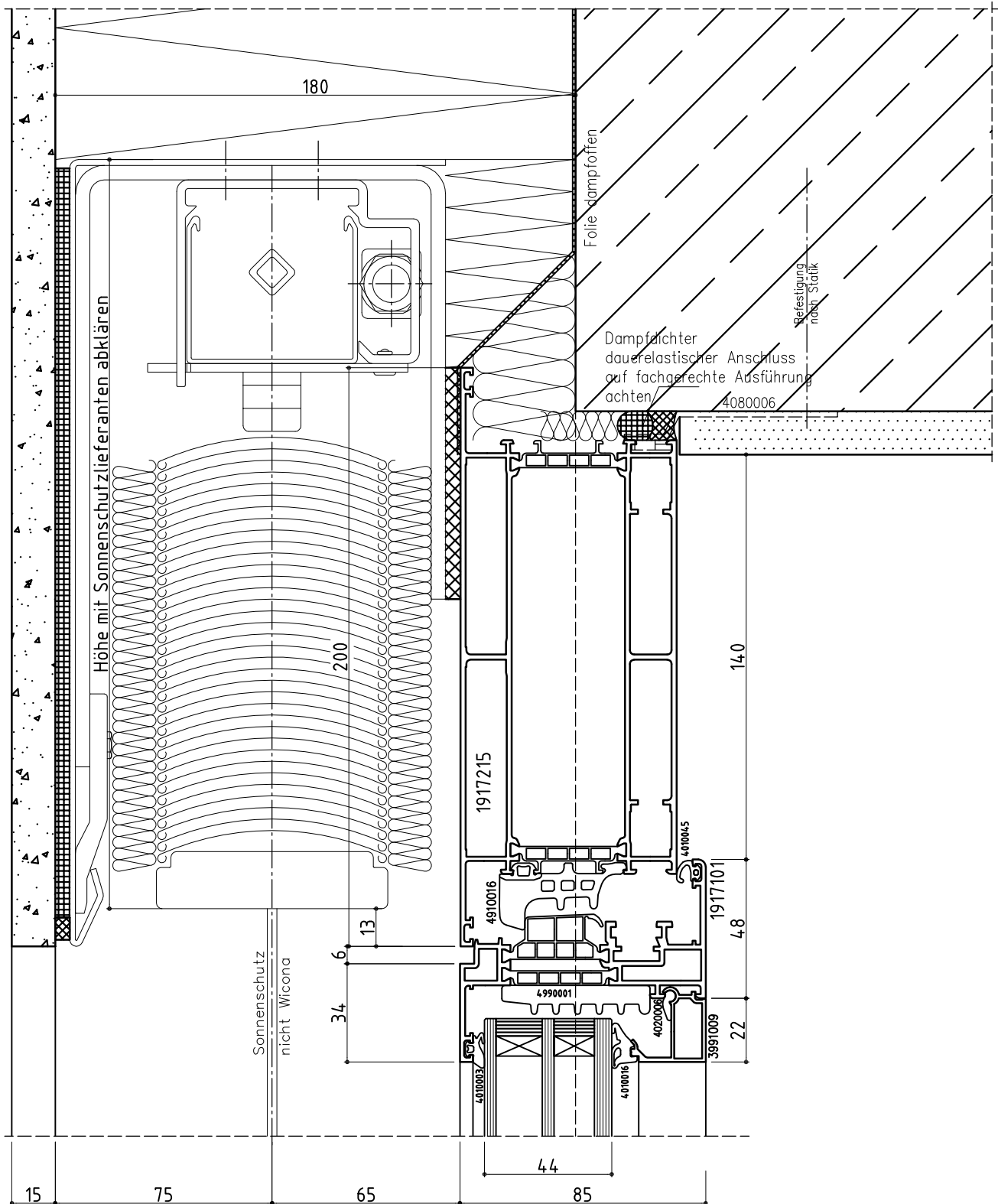
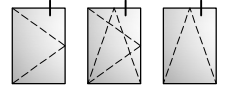

Der dargestellte Bauanschluss ist bauphysikalisch zu überprüfen.
The shown junction to the structure, has to be checked concerning the construction physics.

WICLINE 75

Bauanschluss oben - Maßstab 1:2

Top junction - Scale 1:2

Bauanschlüsse
Junction to structure

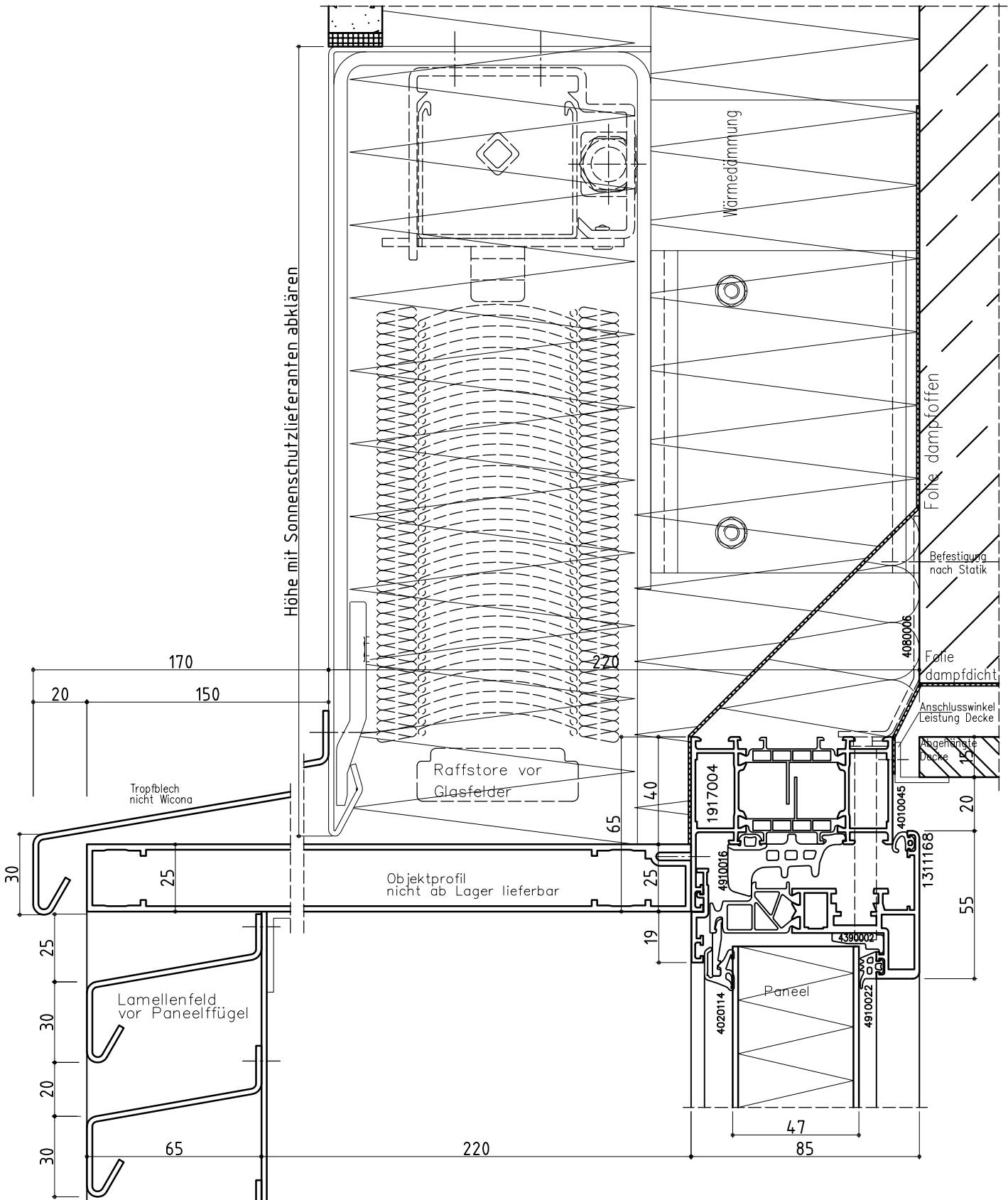

Der dargestellte Bauanschluss ist bauphysikalisch zu überprüfen.

The shown junction to the structure, has to be checked concerning the construction physics.

WICONA®

WICLINE 75

Bauanschluss oben - Maßstab 1:2

Top junction - Scale 1:2

Bauanschlüsse
Junction to structure

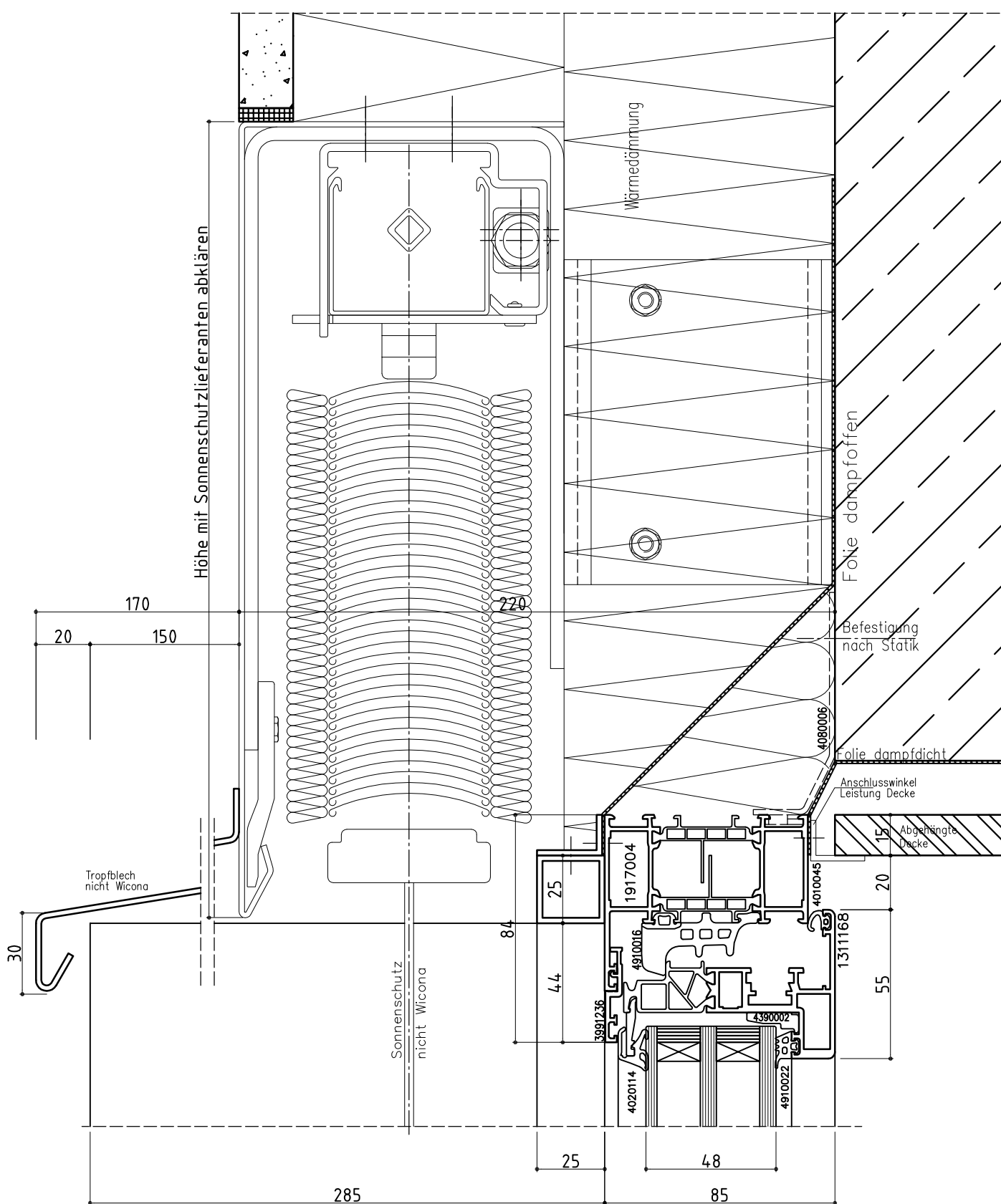
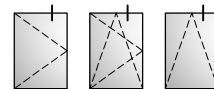

Der dargestellte Bauanschluss ist bauphysikalisch zu überprüfen.

The shown junction to the structure, has to be checked concerning the construction physics.

WICLINE 75

Bauanschluss oben - Maßstab 1:2

Top junction - Scale 1:2

Bauanschlüsse
Junction to structure

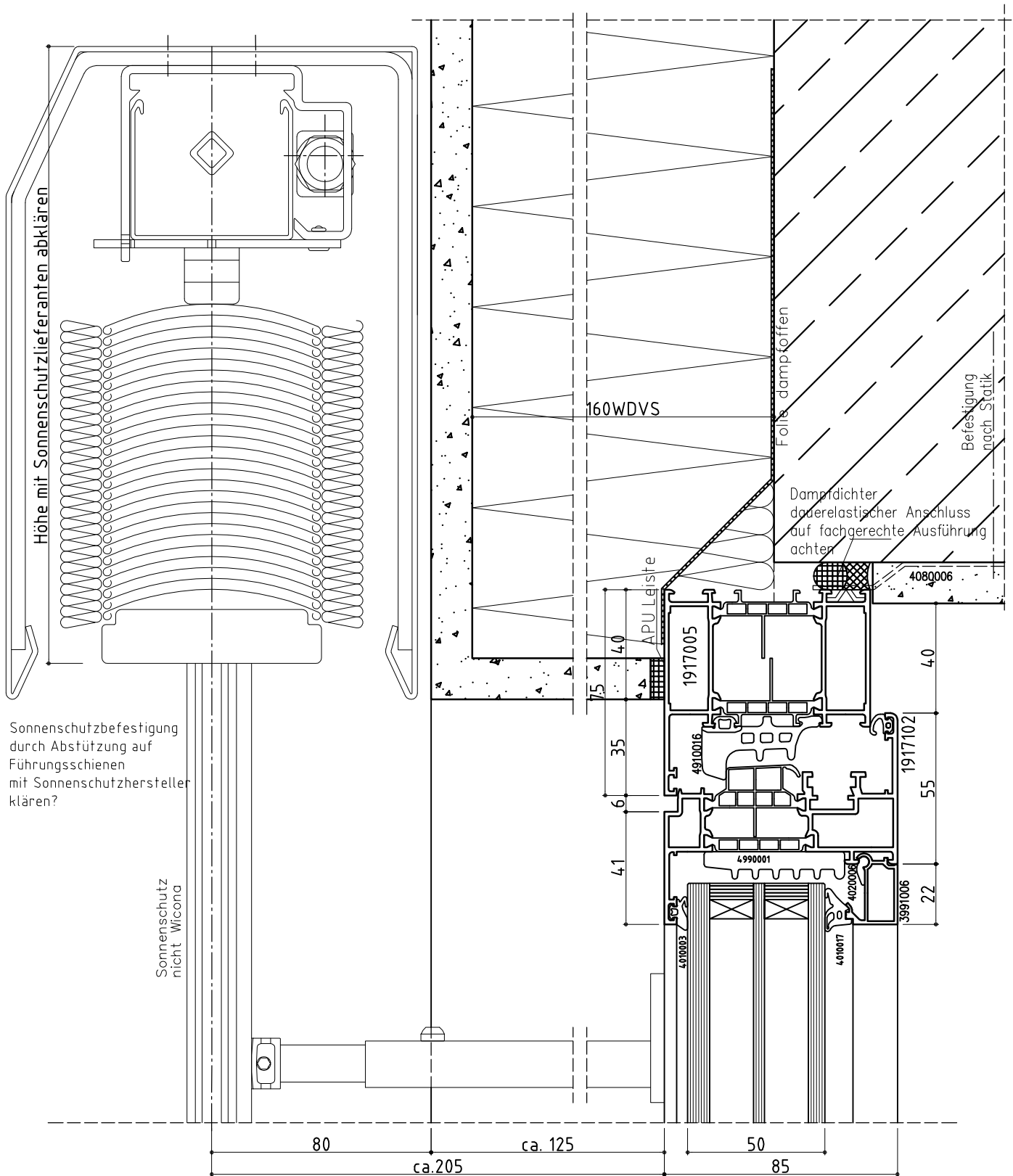

Der dargestellte Bauanschluss ist bauphysikalisch zu überprüfen.
The shown junction to the structure, has to be checked concerning the construction physics.



WICLINE 75

Bauanschluss oben - Maßstab 1:2

Top junction - Scale 1:2

Bauanschlüsse
Junction to structure

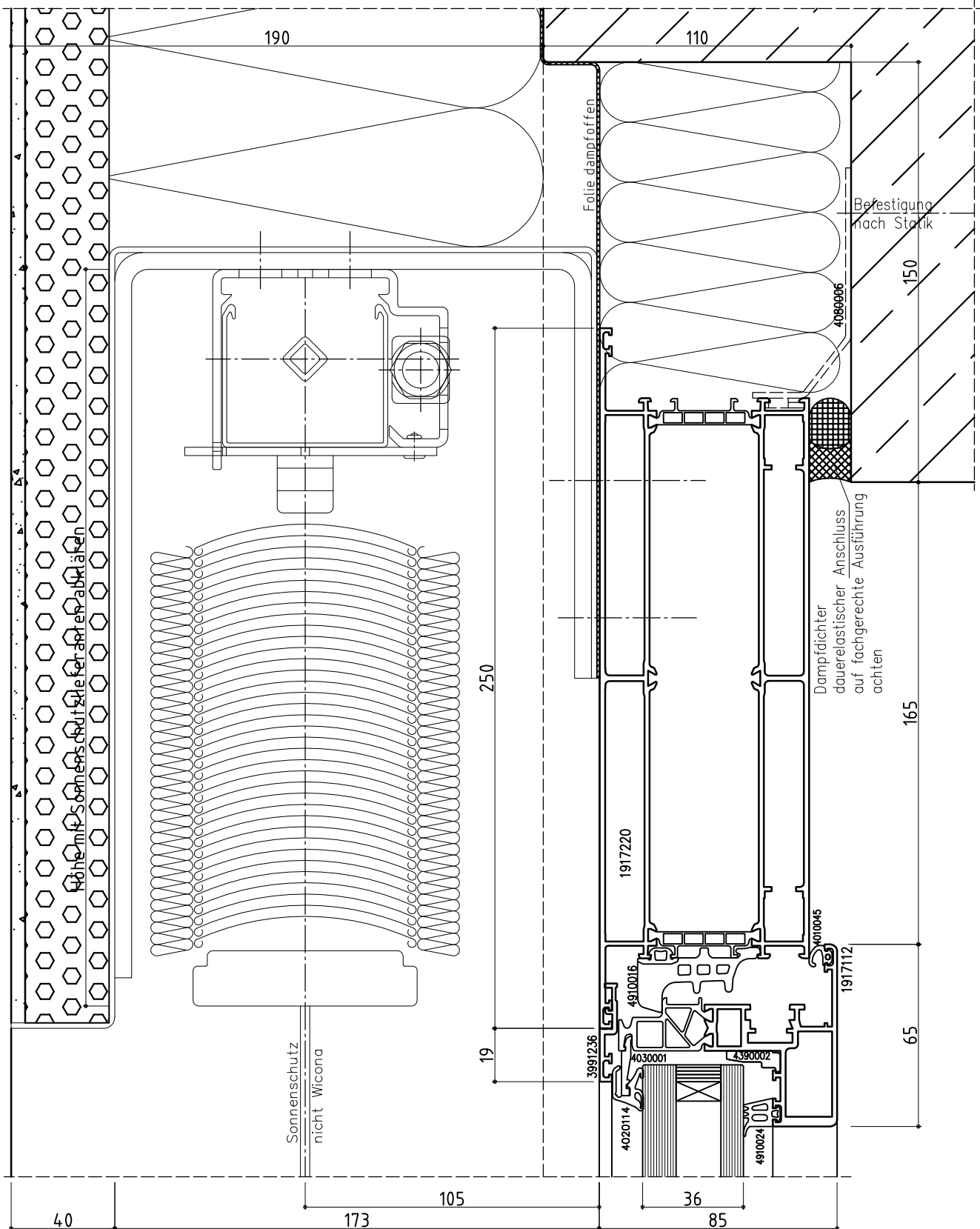

Der dargestellte Bauanschluss ist bauphysikalisch zu überprüfen.

The shown junction to the structure, has to be checked concerning the construction physics.

WICLINE 75

Bauanschluss oben - Maßstab 1:2

Top junction - Scale 1:2

Bauanschlüsse
Junction to structure

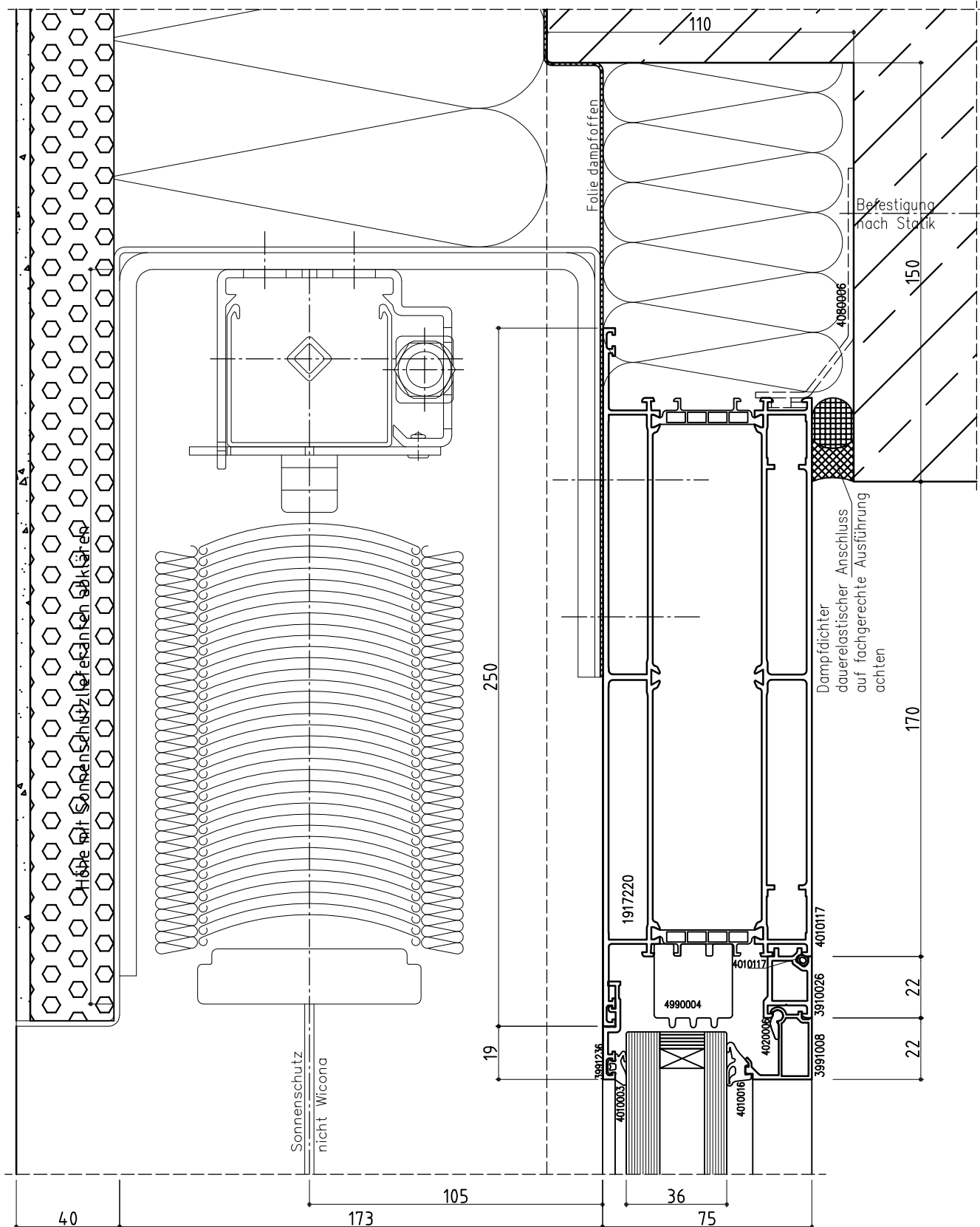

Der dargestellte Bauanschluss ist bauphysikalisch zu überprüfen.
The shown junction to the structure, has to be checked concerning the construction physics.

WICONA®

WICLINE 75

Bauanschluss oben - Maßstab 1:2

Top junction - Scale 1:2

Bauanschlüsse
Junction to structure

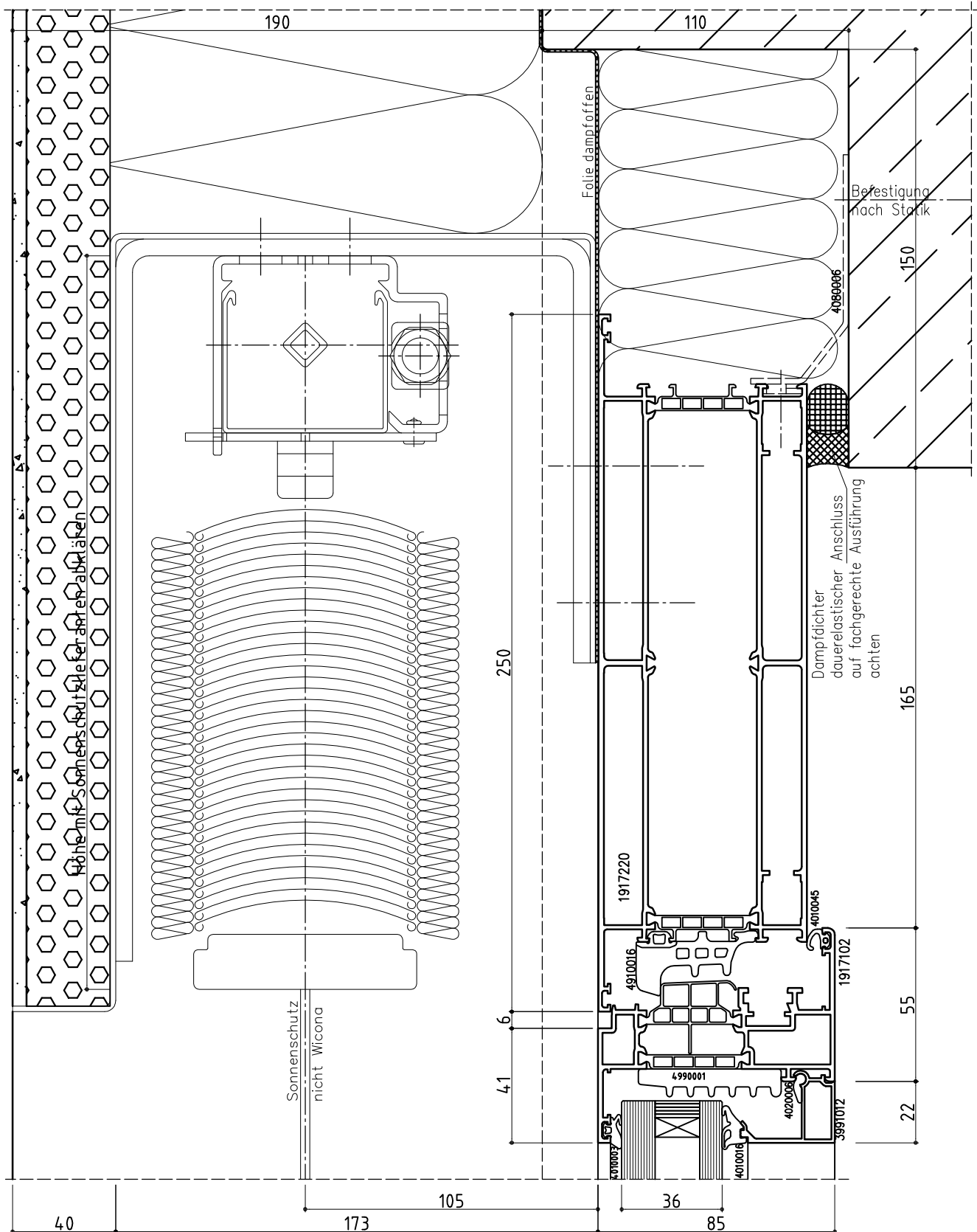

Der dargestellte Bauanschluss ist bauphysikalisch zu überprüfen.
The shown junction to the structure, has to be checked concerning the construction physics.

WICONA®

WICLINE 75

Bauanschluss oben - Maßstab 1:2

Top junction - Scale 1:2

Bauanschlüsse
Junction to structure

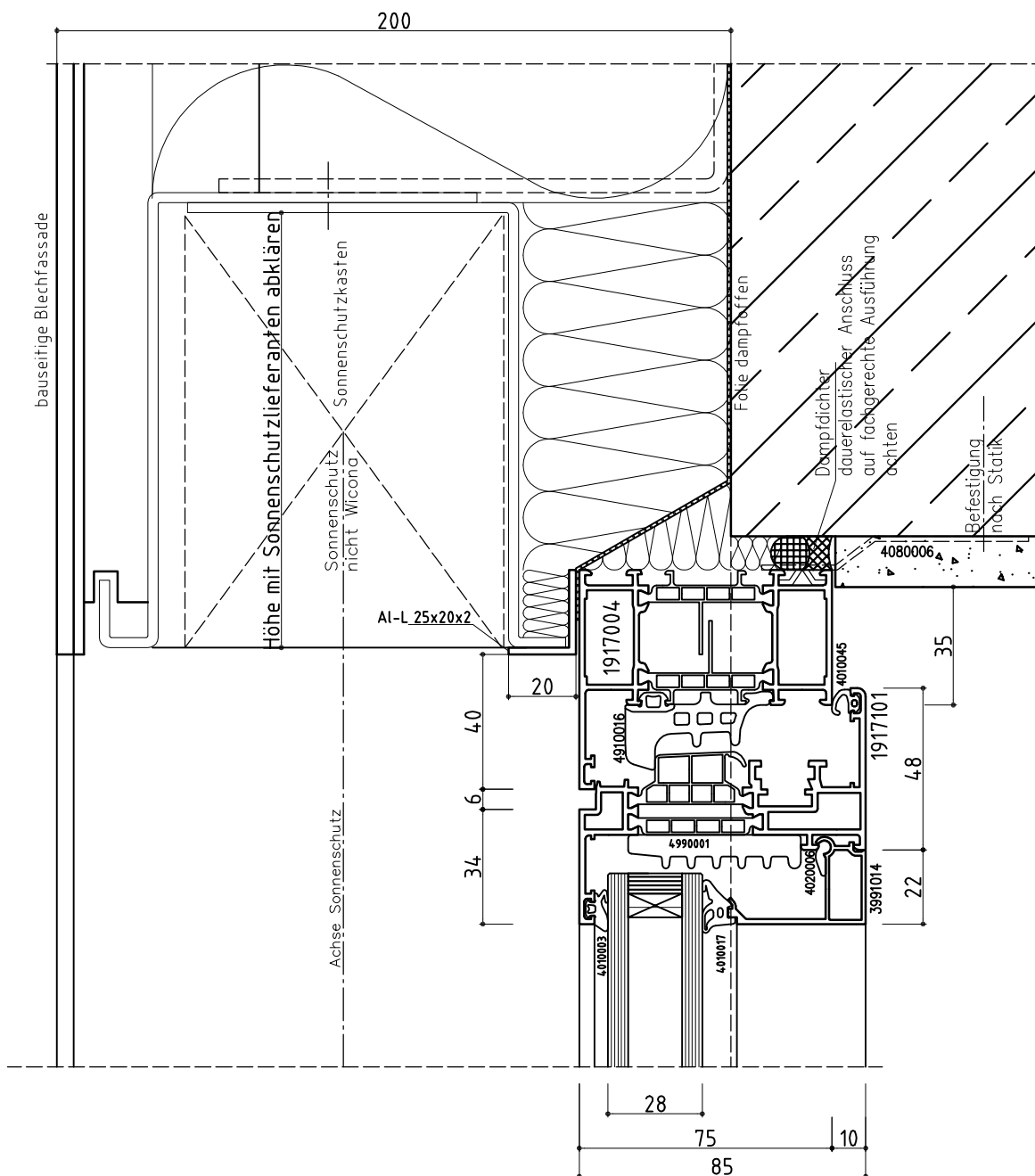
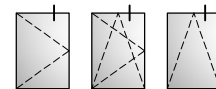

Der dargestellte Bauanschluss ist bauphysikalisch zu überprüfen.
The shown junction to the structure, has to be checked concerning the construction physics.

WICLINE 75

Bauanschluss oben - Maßstab 1:2

Top junction - Scale 1:2

Bauanschlüsse
Junction to structure

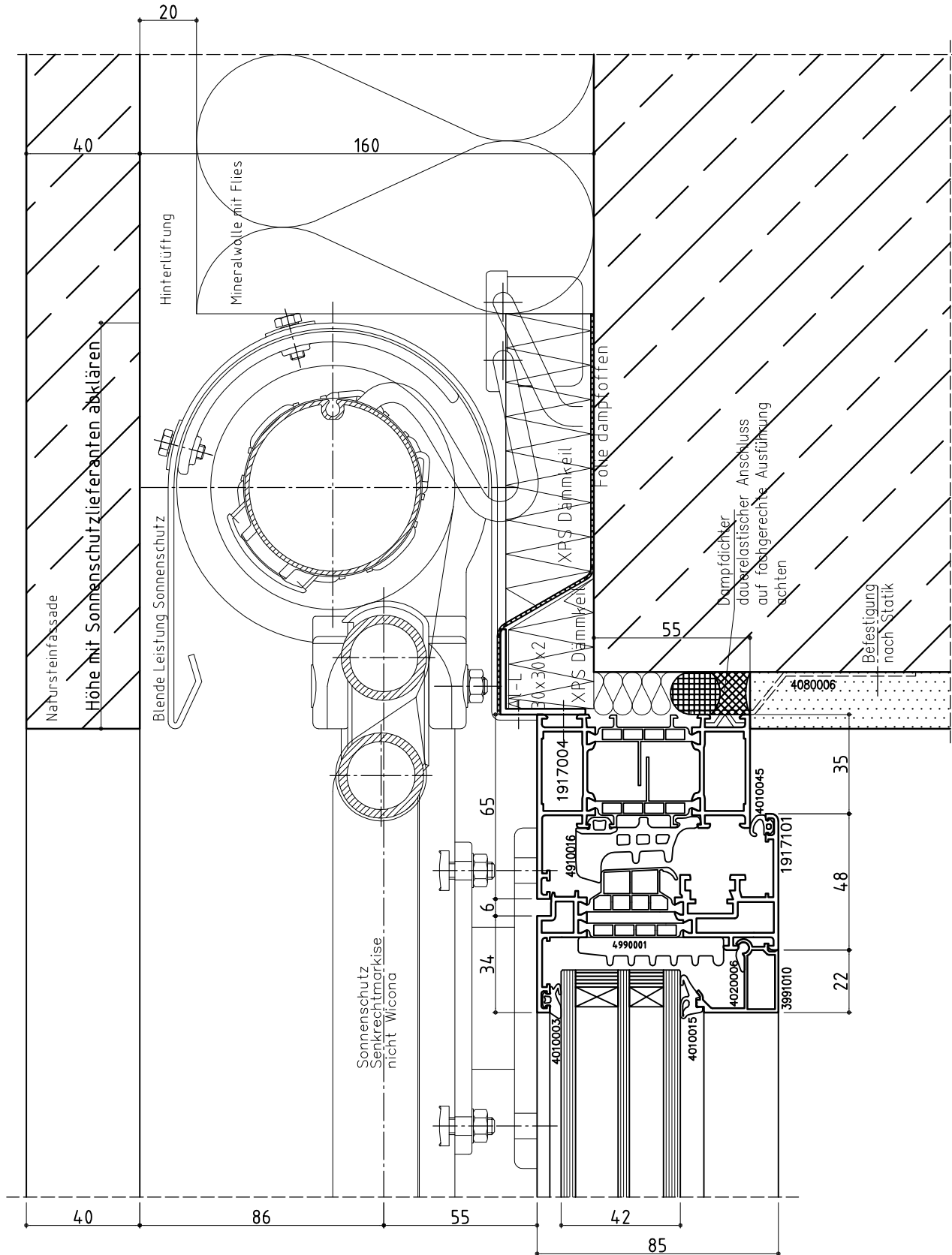
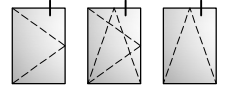

Der dargestellte Bauanschluss ist bauphysikalisch zu überprüfen.

The shown junction to the structure, has to be checked concerning the construction physics.

WICLINE 75

Bauanschluss oben - Maßstab 1:2

Top junction - Scale 1:2

Bauanschlüsse
Junction to structure

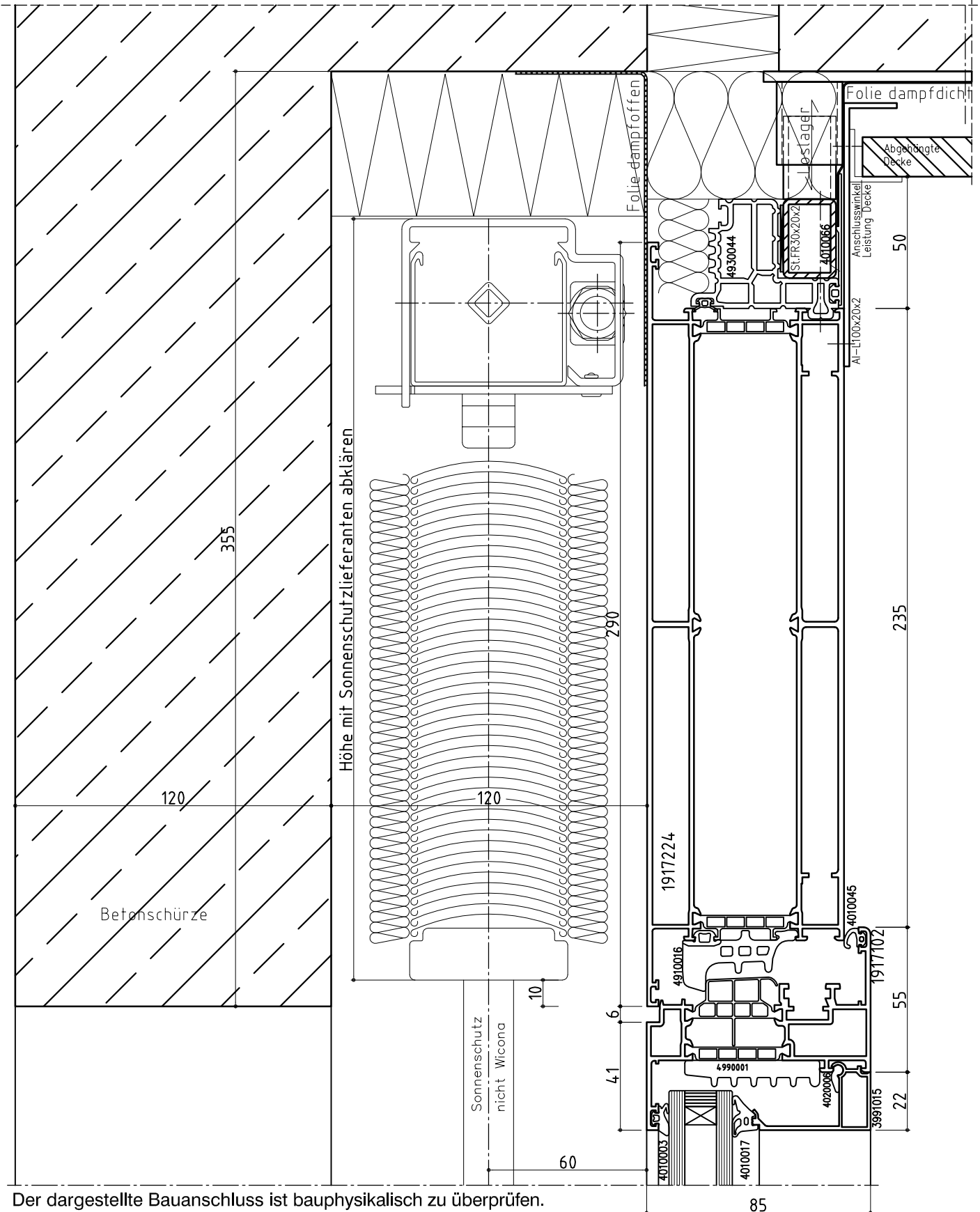
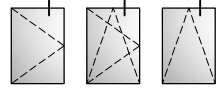

Der dargestellte Bauanschluss ist bauphysikalisch zu überprüfen.
The shown junction to the structure, has to be checked concerning the construction physics.

WICONA®

WICLINE 75

Bauanschluss oben - Maßstab 1:2

Top junction - Scale 1:2

Bauanschlüsse
 Junction to structure

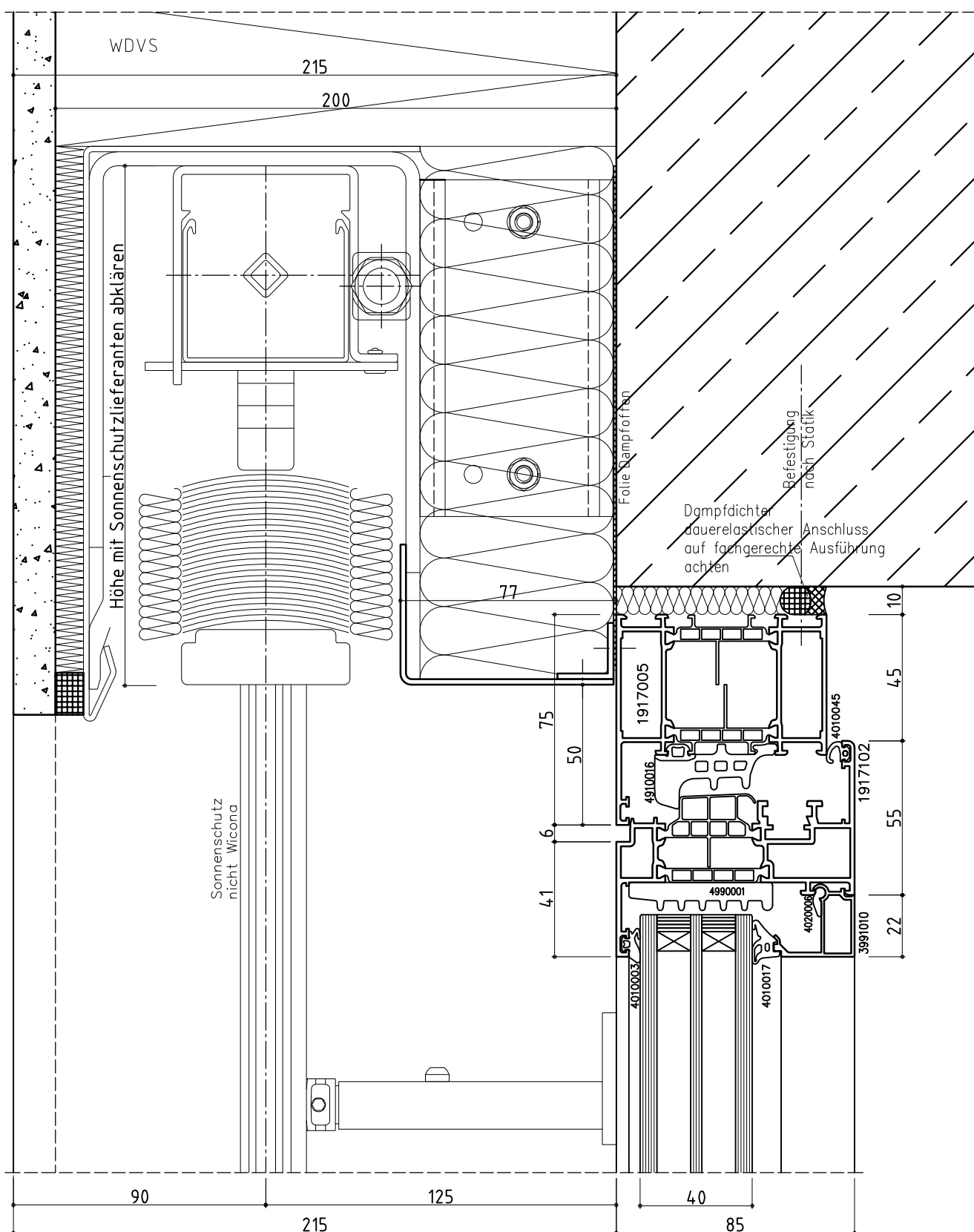
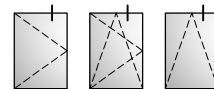

Der dargestellte Bauanschluss ist bauphysikalisch zu überprüfen.
 The shown junction to the structure, has to be checked concerning the construction physics.

WICONA®

WICLINE 75

Bauanschluss oben - Maßstab 1:2

Top junction - Scale 1:2

Bauanschlüsse
Junction to structure

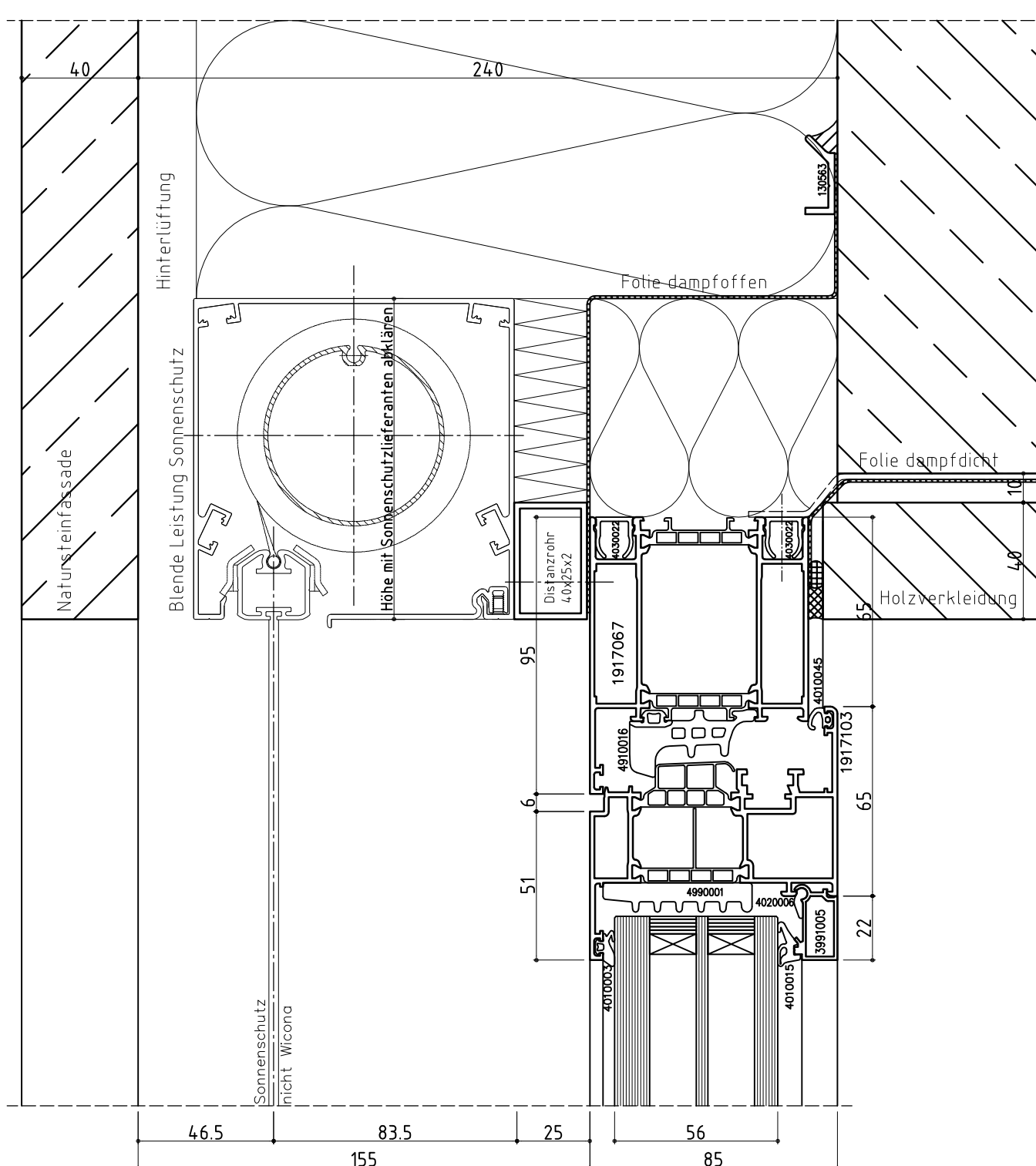
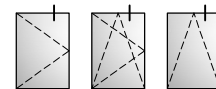

Der dargestellte Bauanschluss ist bauphysikalisch zu überprüfen.
The shown junction to the structure, has to be checked concerning the construction physics.

WICONA®

WICLINE 75

Bauanschluss oben - Maßstab 1:2

Top junction - Scale 1:2

Bauanschlüsse
Junction to structure

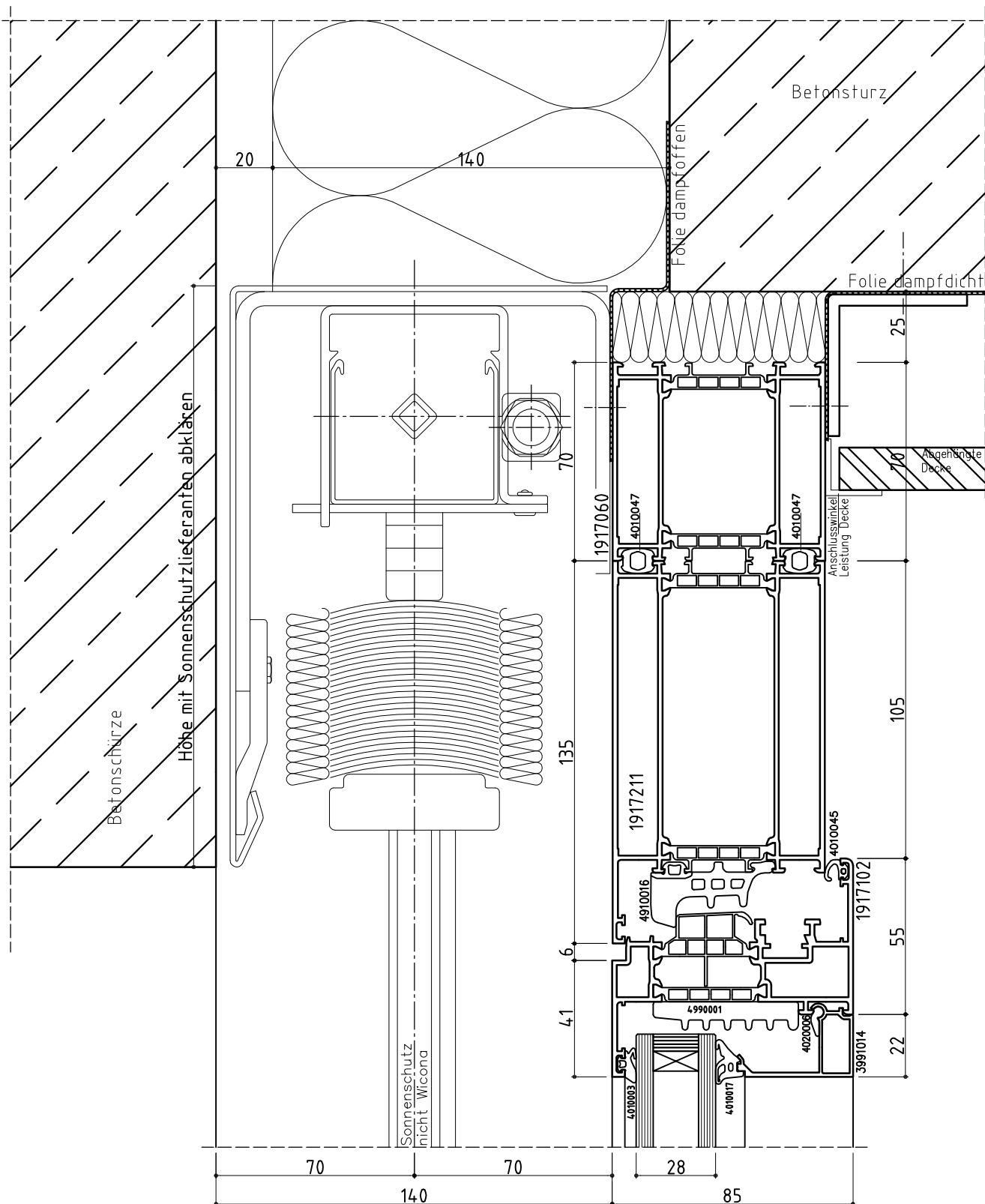
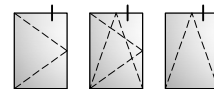

Der dargestellte Bauanschluss ist bauphysikalisch zu überprüfen.
The shown junction to the structure, has to be checked concerning the construction physics.

WICONA®

WICLINE 75

Bauanschluss
Top junction

Bauanschlüsse
Junction to structure

» Profile

Profiles



WICLINE 65

Blendrahmenprofile
Frame profiles

Statische Werte
Statical values

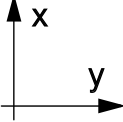
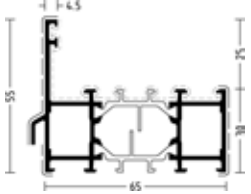
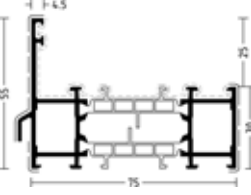
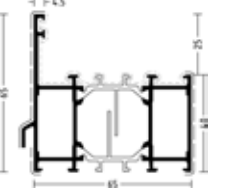
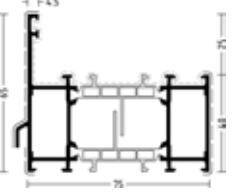
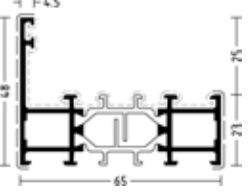
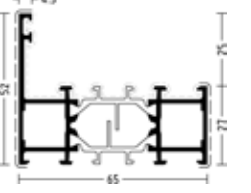

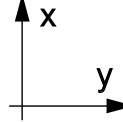
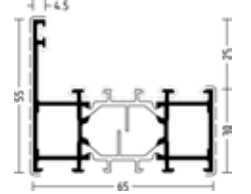
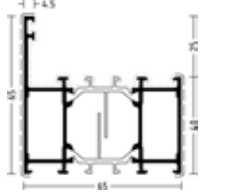
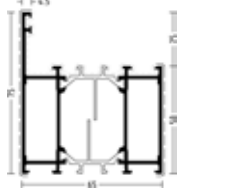
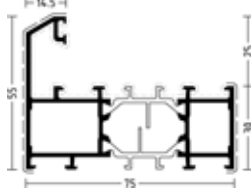
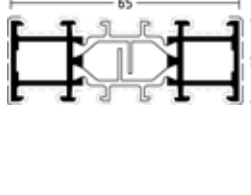
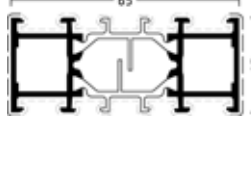
	Artikel-Nr. / Article-no.				
	lx	eff (cm ⁴) nach IfBt-Richtlinien eff (cm ⁴) acc. to IfBt guidelines			
	ly	add (cm ⁴) add (cm ⁴)			
		Stützweite L ab (cm) Bearing span L from (cm)			
		200	250	300	400
	1010343				
	lx	19.01	21.06	22.37	23.85
	ly	6.84			
	1010344				
	lx	26.34	29.37	31.32	33.54
	ly	6.84			
	1010345				
	lx	21.13	23.68	25.35	27.25
	ly	12.35			
	1010346				
	lx	29.19	32.94	35.41	38.27
	ly	12.35			
	1916001				
	lx	16.11	17.62	18.57	19.62
	ly	4.22			
	1916002				
	lx	16.82	18.58	19.70	20.96
	ly	5.56			

	Artikel-Nr. / Article-no.				
	lx	eff (cm ⁴) nach IfBt-Richtlinien eff (cm ⁴) acc. to IfBt guidelines			
	ly	add (cm ⁴) add (cm ⁴)			
		Stützweite L ab (cm) Bearing span L from (cm)			
		200	250	300	400
	1916003				
	lx	17.61	19.53	20.76	22.15
	ly	6.76			
	1916004				
	lx	19.97	22.33	23.87	25.61
	ly	12.11			
	1916005				
	lx	21.94	24.80	26.69	28.88
	ly	19.77			
	1916009				
	lx	24.98	27.75	29.53	31.55
	ly	8.96			
	1916055				
	lx	13.07	14.21	14.91	15.68
	ly	1.37			
	1916056				
	lx	14.03	15.34	16.17	17.08
	ly	2.22			

WICLINE 65

Blendrahmenprofile
Frame profiles

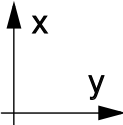
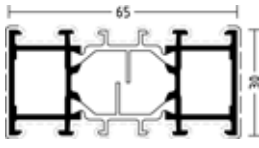
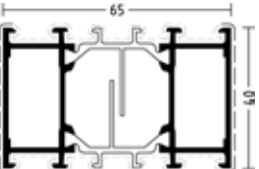
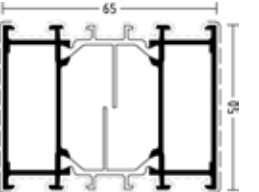
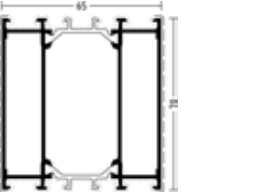
Statische Werte
Statical values

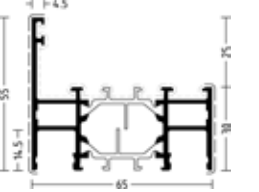
		Artikel-Nr. / Article-no.				
		lx	eff (cm ⁴) nach IfBt-Richtlinien eff (cm ⁴) acc. to IfBt guidelines			
		ly	add (cm ⁴) add (cm ⁴)			
		Stützweite L ab (cm) Bearing span L from (cm)				
			200	250	300	400
	1916057	lx	14.86	16.32	17.24	18.27
	ly	3.03				
	1916058	lx	17.31	19.17	20.37	21.71
	ly	6.91				
	1916059	lx	19.40	21.73	23.26	25.00
	ly	12.85				
	1916060	lx	23.12	26.45	28.70	31.34
	ly	32.13				
	1910171	lx	34.90	42.97	49.14	57.32
	ly	213.05				
	1916062	lx	17.86	19.87	21.17	22.63
	ly	6.04				

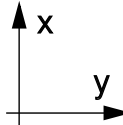
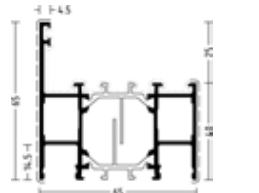
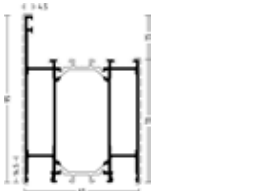
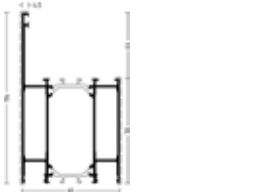
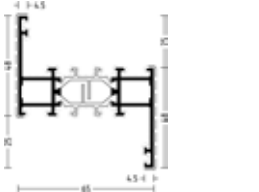
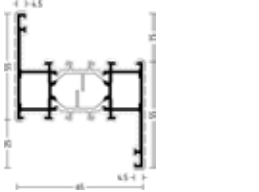
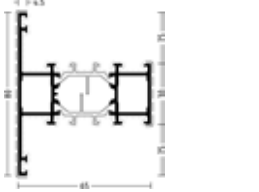
		Artikel-Nr. / Article-no.				
		lx	eff (cm ⁴) nach IfBt-Richtlinien eff (cm ⁴) acc. to IfBt guidelines			
		ly	add (cm ⁴) add (cm ⁴)			
		Stützweite L ab (cm) Bearing span L from (cm)				
			200	250	300	400
	1916064	lx	20.25	22.71	24.32	26.15
	ly	11.07				
	1916067	lx	25.61	29.61	32.34	35.62
	ly	41.77				
	1910169	lx	26.88	31.31	34.39	38.11
	ly	57.04				
	1916068	lx	19.46	21.65	23.05	24.65
	ly	7.07				
	1916069	lx	20.90	23.47	25.16	27.08
	ly	10.50				
	1916073	lx	19.58	21.89	23.38	25.08
	ly	12.61				

WICLINE 65

Blendrahmenprofile
Frame profiles

Statische Werte
Statical values

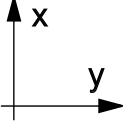
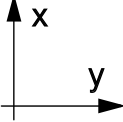
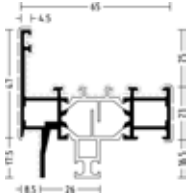
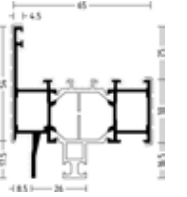
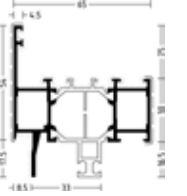
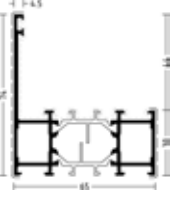
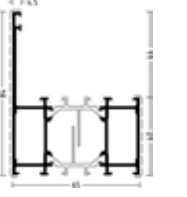
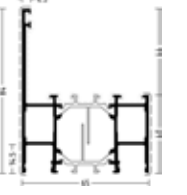
		Artikel-Nr. / Article-no.			
		lx	eff (cm ⁴) nach IfBt-Richtlinien eff (cm ⁴) acc. to IfBt guidelines		
		ly	add (cm ⁴) add (cm ⁴)		
		Stützweite L ab (cm) Bearing span L from (cm)			
		200	250	300	400
	1916076				
	lx	16.69	18.41	19.51	20.74
	ly	6.58			
	1916077				
	lx	18.31	20.36	21.68	23.18
	ly	9.86			
	1910133				
	lx	18.31	20.36	21.68	23.18
	ly	9.86			
	1916081				
	lx	19.53	21.71	23.11	24.70
	ly	13.78			
	1916082				
	lx	21.65	24.34	26.11	28.14
	ly	20.85			
	1916086				
	lx	21.92	24.72	26.57	28.70
	ly	19.69			

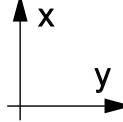
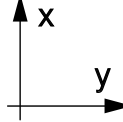
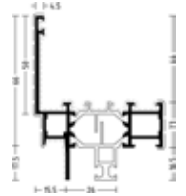
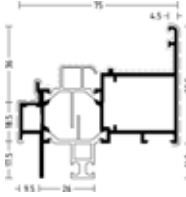
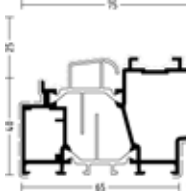

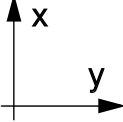
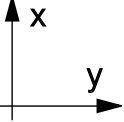
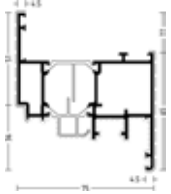
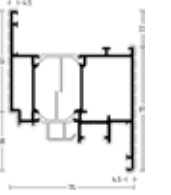
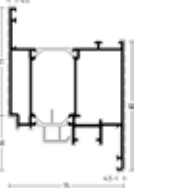
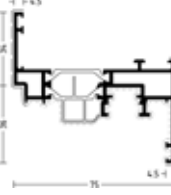
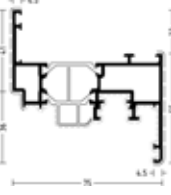
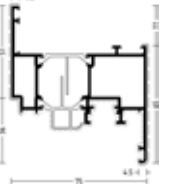
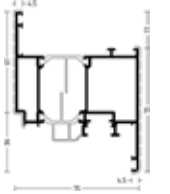
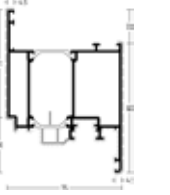
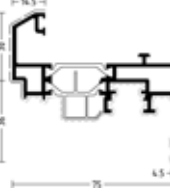
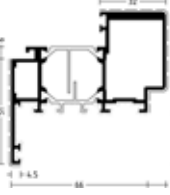
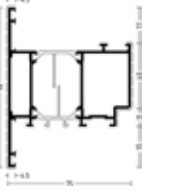
		Artikel-Nr. / Article-no.			
		lx	eff (cm ⁴) nach IfBt-Richtlinien eff (cm ⁴) acc. to IfBt guidelines		
		ly	add (cm ⁴) add (cm ⁴)		
		Stützweite L ab (cm) Bearing span L from (cm)			
		200	250	300	400
	1916089				
	lx	17.15	18.93	20.07	21.34
	ly	13.30			
	1916092				
	lx	25.05	27.71	29.41	31.32
	ly	9.49			
	1916093				
	lx	25.42	28.48	30.48	32.77
	ly	13.16			

		Artikel-Nr. / Article-no.				
		lx	eff (cm ⁴) nach IfBt-Richtlinien eff (cm ⁴) acc. to IfBt guidelines			
		ly	add (cm ⁴) add (cm ⁴)			
		Stützweite L ab (cm) Bearing span L from (cm)				
			200	250	300	400
	1916116					
	lx	30.61	34.56	37.16	40.16	
	ly	16.96				
	1916117					
	lx	33.27	37.95	41.10	44.79	
	ly	26.99				
	1916118					
	lx	35.54	40.95	44.63	49.02	
	ly	40.22				
	1916101					
	lx	26.03	28.79	30.55	32.52	
	ly	6.27				
	1916102					
	lx	28.08	31.35	33.46	35.87	
	ly	9.53				
	1916103					
	lx	30.71	34.66	37.27	40.29	
	ly	16.31				
	1916104					
	lx	33.36	38.06	41.22	44.92	
	ly	26.02				
	1916115					
	lx	35.64	41.06	44.75	49.15	
	ly	38.89				
	1916105					
	lx	25.55	28.36	30.17	32.20	
	ly	6.36				
	1916161					
	lx	28.03	31.84	34.39	37.35	
	ly	16.39				
	1916163					
	lx	30.91	35.44	38.51	42.14	
	ly	30.27				

WICLINE 65

Stulpflügelprofile
Double casement sash profiles

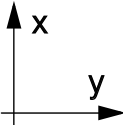
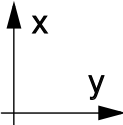
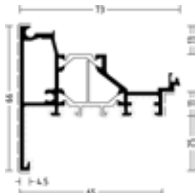
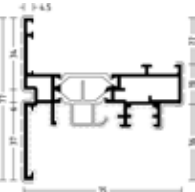
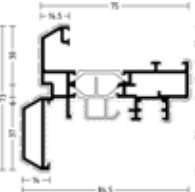
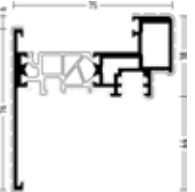
Statische Werte
Statical values

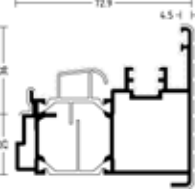
		Artikel-Nr. / Article-no.			
		lx	eff (cm ⁴) nach IfBt-Richtlinien eff (cm ⁴) acc. to IfBt guidelines		
		ly	add (cm ⁴) add (cm ⁴)		
		Stützweite L ab (cm) Bearing span L from (cm)			
		200	250	300	400
	1916121				
	lx	18.35	20.29	21.53	22.92
	ly	9.64			
	1916120				
	lx	26.17	29.54	31.77	34.34
	ly	11.18			
	1916122				
	lx	30.30	34.55	37.39	40.73
	ly	15.18			
	1916124				
	lx	23.22	28.13	31.77	36.47
	ly	14.23			
	1916126				
	lx	22.83	27.69	31.30	35.98
	ly	14.98			
	1916167				
	lx	25.16	27.73	29.36	31.19
	ly	13.17			

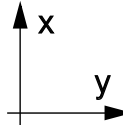
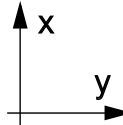
		Artikel-Nr. / Article-no.			
		lx	eff (cm ⁴) nach IfBt-Richtlinien eff (cm ⁴) acc. to IfBt guidelines		
		ly	add (cm ⁴) add (cm ⁴)		
		Stützweite L ab (cm) Bearing span L from (cm)			
		200	250	300	400

WICLINE 65

Kämpfer, Sprossenprofile
Transom, Crossbar profiles

Statische Werte
Statical values

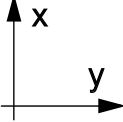
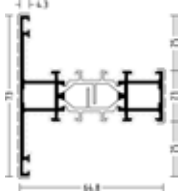
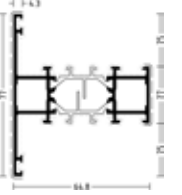
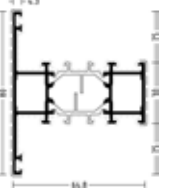
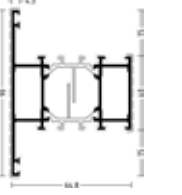
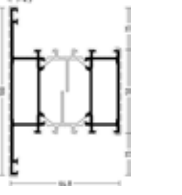
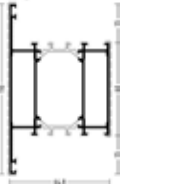
		Artikel-Nr. / Article-no.				
		lx	eff (cm ⁴) nach IfBt-Richtlinien eff (cm ⁴) acc. to IfBt guidelines			
		ly	add (cm ⁴) add (cm ⁴)			
		Stützweite L ab (cm) Bearing span L from (cm)				
			200	250	300	400
	1916201					
	lx	17.87	19.67	20.82	22.09	
	ly	8.52				
	1916202					
	lx	18.55	20.63	21.97	23.48	
	ly	10.45				
	1916203					
	lx	19.32	21.58	23.04	24.70	
	ly	12.13				
	1916204					
	lx	21.69	24.41	26.20	28.25	
	ly	19.20				
	1916205					
	lx	23.60	26.85	29.02	31.55	
	ly	28.84				
	1916206					
	lx	25.35	29.13	31.70	34.74	
	ly	41.33				

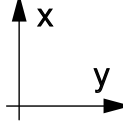
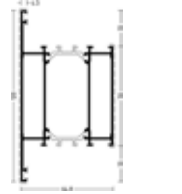
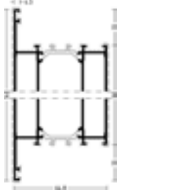
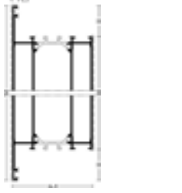
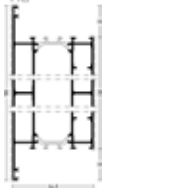
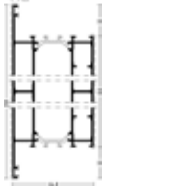
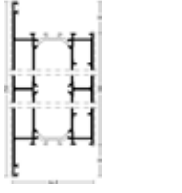
		Artikel-Nr. / Article-no.				
		lx	eff (cm ⁴) nach IfBt-Richtlinien eff (cm ⁴) acc. to IfBt guidelines			
		ly	add (cm ⁴) add (cm ⁴)			
		Stützweite L ab (cm) Bearing span L from (cm)				
			200	250	300	400
	1916207					
	lx	26.97	31.28	34.25	37.82	
	ly	57.00				
	1916209					
	lx	30.39	35.98	39.97	44.92	
	ly	100.21				
	1916211					
	lx	32.95	39.63	44.52	50.76	
	ly	160.00				
	1916213					
	lx	36.43	44.92	51.44	60.10	
	ly	246.21				
	1916215					
	lx	38.63	48.26	55.82	66.11	
	ly	353.74				
	1916220					
	lx	43.08	55.50	65.81	80.71	
	ly	769.17				

WICLINE 65

Kämpfer, Sprossenprofile
Transom, Crossbar profiles

Statische Werte
Statical values

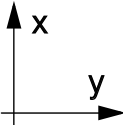
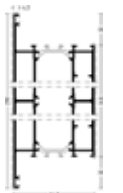
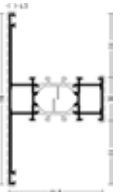
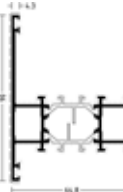
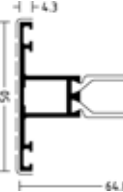
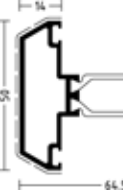
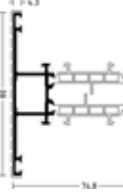
	Artikel-Nr. / Article-no.				
	lx	eff (cm ⁴) nach IfBt-Richtlinien eff (cm ⁴) acc. to IfBt guidelines			
	ly	add (cm ⁴) add (cm ⁴)			
		Stützweite L ab (cm) Bearing span L from (cm)			
		200	250	300	400
	1916224				
	lx	46.93	61.75	74.53	93.83
	ly	1281.31			
	1916231				
	lx	21.63	24.37	26.16	28.23
	ly	33.41			
	1916235				
	lx	20.13	22.54	24.12	25.92
	ly	17.80			
	1916336				
	lx	15.83	17.28	18.18	19.18
	ly	2.93			
	1916338				
	lx	14.97	16.48	17.44	18.50
	ly	5.09			
	1917203				
	lx	27.17	30.41	32.52	34.93
	ly	12.13			

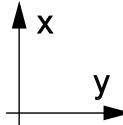
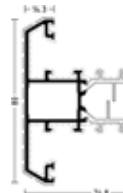
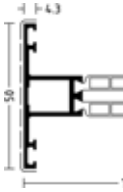
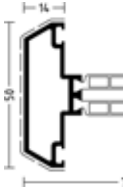
	Artikel-Nr. / Article-no.				
	lx	eff (cm ⁴) nach IfBt-Richtlinien eff (cm ⁴) acc. to IfBt guidelines			
	ly	add (cm ⁴) add (cm ⁴)			
		Stützweite L ab (cm) Bearing span L from (cm)			
		200	250	300	400
	1916334				
	lx	27.19	30.55	32.74	35.26
	ly	18.72			
	1917336				
	lx	22.41	24.50	25.81	27.25
	ly	2.93			
	1917338				
	lx	21.78	23.94	25.30	26.82
	ly	5.09			

WICLINE 65

Stützenprofile
Mullion profiles for windows

Statische Werte
Statical values

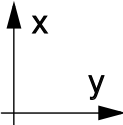
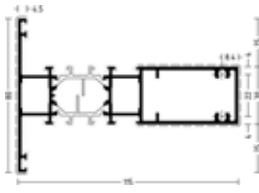
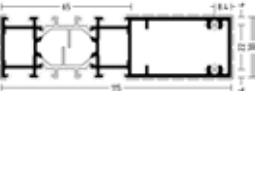
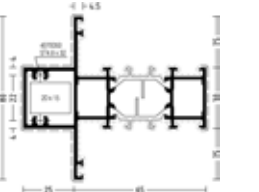
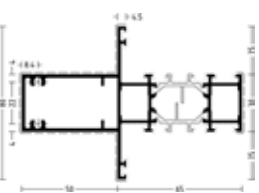
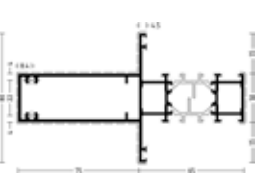
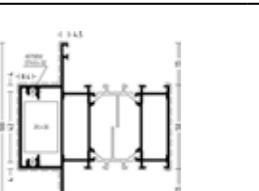
	Artikel-Nr. / Article-no.				
	lx	eff (cm ⁴) nach IfBt-Richtlinien eff (cm ⁴) acc. to IfBt guidelines			
	ly	add (cm ⁴) add (cm ⁴)			
		Stützweite L ab (cm) Bearing span L from (cm)			
		200	250	300	400
	1916241				
	lx	76.83	88.33	96.14	105.41
	ly	17.10			
	1916244				
	lx	64.94	71.81	76.19	81.11
	ly	7.52			
	1916246				
	lx	35.33	39.65	42.48	45.72
	ly	15.14			
	1916247				
	lx	64.34	71.37	75.87	80.95
	ly	17.10			
	1916248				
	lx	111.55	122.27	129.01	136.48
	ly	18.89			
	1916249				
	lx	44.52	51.00	55.38	60.54
	ly	38.42			

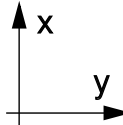
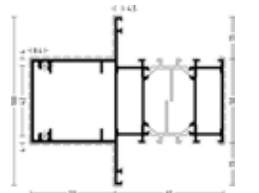
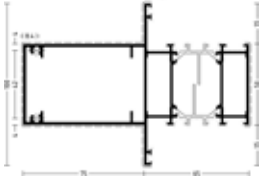
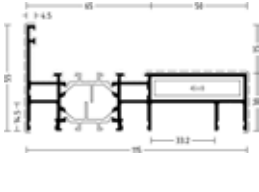
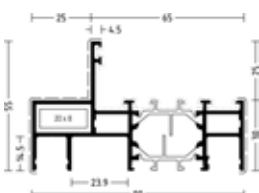
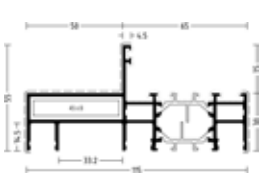
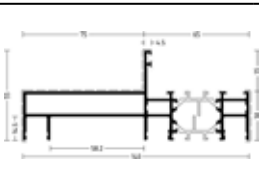
	Artikel-Nr. / Article-no.				
	lx	eff (cm ⁴) nach IfBt-Richtlinien eff (cm ⁴) acc. to IfBt guidelines			
	ly	add (cm ⁴) add (cm ⁴)			
		Stützweite L ab (cm) Bearing span L from (cm)			
		200	250	300	400
	1916250				
	lx	80.27	90.81	97.78	105.87
	ly	44.46			
	1916251				
	lx	119.76	153.18	163.57	175.41
	ly	49.69			
	1916256				
	lx	68.76	77.82	83.82	90.78
	ly	8.04			
	1916258				
	lx	33.77	37.80	40.42	43.41
	ly	6.97			
	1916259				
	lx	62.06	68.96	73.39	78.40
	ly	8.09			
	1916260				
	lx	106.99	117.75	124.56	132.16
	ly	8.53			

WICLINE 65

Stützenprofile
Mullion profiles for windows

Statische Werte
Statical values

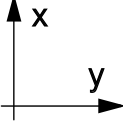
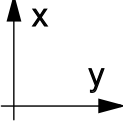
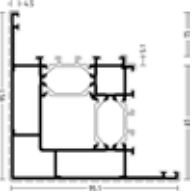
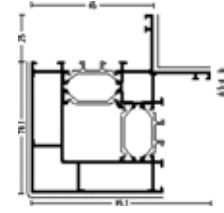
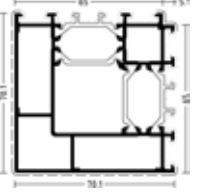
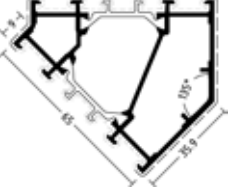

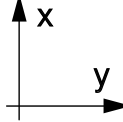
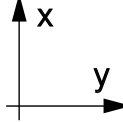
		Artikel-Nr. / Article-no.				
		lx	eff (cm ⁴) nach IfBt-Richtlinien eff (cm ⁴) acc. to IfBt guidelines			
		ly	add (cm ⁴) add (cm ⁴)			
		Stützweite L ab (cm) Bearing span L from (cm)				
			200	250	300	400
		1916270				
		lx	48.59	48.59	48.59	54.65
		ly	48.59			
		1916271				
		lx	30.87	30.87	30.87	30.87
		ly	45.99			
		1916272				
		lx	34.57	36.61	37.82	39.10
		ly	32.71			
		1916273				
		lx	16.83	18.48	19.51	20.66
		ly	10.74			

		Artikel-Nr. / Article-no.				
		lx	eff (cm ⁴) nach IfBt-Richtlinien eff (cm ⁴) acc. to IfBt guidelines			
		ly	add (cm ⁴) add (cm ⁴)			
		Stützweite L ab (cm) Bearing span L from (cm)				
			200	250	300	400

WICLINE 65

Schwellenprofile
Threshold profiles

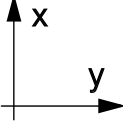
Statische Werte
Statical values

		Artikel-Nr. / Article-no.			
		lx	eff (cm ⁴) nach IfBt-Richtlinien eff (cm ⁴) acc. to IfBt guidelines		
ly	add (cm ⁴) add (cm ⁴)		Stützweite L ab (cm) Bearing span L from (cm)		
	200	250	300	400	
		1916304			
lx	10.19	11.61	12.56	13.67	
ly	0.57				
		1916305			
lx	9.77	11.18	12.13	13.25	
ly	0.56				

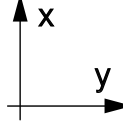
		Artikel-Nr. / Article-no.			
		lx	eff (cm ⁴) nach IfBt-Richtlinien eff (cm ⁴) acc. to IfBt guidelines		
ly	add (cm ⁴) add (cm ⁴)		Stützweite L ab (cm) Bearing span L from (cm)		
	200	250	300	400	

WICLINE 65

Bauanschlussprofile
Profiles for junction to structure

Statische Werte
Statical values

Artikel-Nr. / Article-no.	
ix	eff (cm ⁴) nach IfBt-Richtlinien eff (cm ⁴) acc. to IfBt guidelines
ly	add (cm ⁴) add (cm ⁴)
Stützweite L ab (cm) Bearing span L from (cm)	
200 250 300 400	

	1916307				
	ix	43.82	50.21	54.52	59.61
	ly	19.65			

Artikel-Nr. / Article-no.	
ix	eff (cm ⁴) nach IfBt-Richtlinien eff (cm ⁴) acc. to IfBt guidelines
ly	add (cm ⁴) add (cm ⁴)
Stützweite L ab (cm) Bearing span L from (cm)	
200 250 300 400	

WICLINE 65

Aufsatzprofile
Supplementary profiles

Statische Werte
Statical values

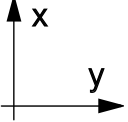
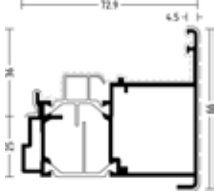
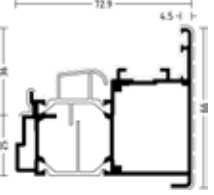
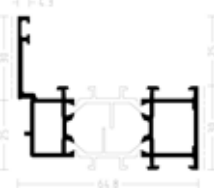
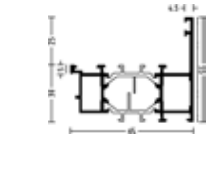
		Artikel-Nr. / Article-no.				
		lx	eff (cm ⁴) nach IfBt-Richtlinien eff (cm ⁴) acc. to IfBt guidelines			
		ly	add (cm ⁴) add (cm ⁴)			
		Stützweite L ab (cm) Bearing span L from (cm)				
			200	250	300	400
		191615				
		lx	24.96	27.38	28.90	30.59
		ly	13.29			
		191616				
		lx	25.09	27.61	29.21	30.99
		ly	14.13			
		1916301				
		lx	16.35	17.99	19.04	20.20
		ly	5.46			
		1916303				
		lx	15.50	17.01	17.95	19.01
		ly	6.26			

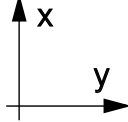
		Artikel-Nr. / Article-no.				
		lx	eff (cm ⁴) nach IfBt-Richtlinien eff (cm ⁴) acc. to IfBt guidelines			
		ly	add (cm ⁴) add (cm ⁴)			
		Stützweite L ab (cm) Bearing span L from (cm)				
			200	250	300	400

WICLINE 75

Blendrahmenprofile
Frame profiles

Statische Werte
Statical values

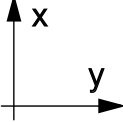
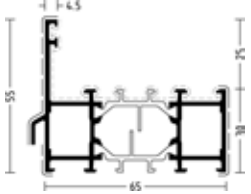
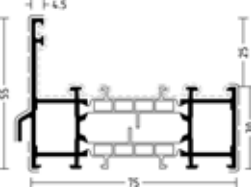
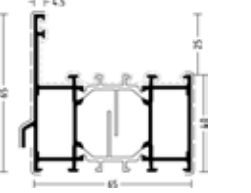
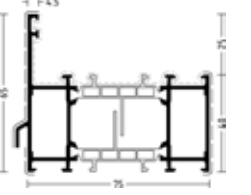
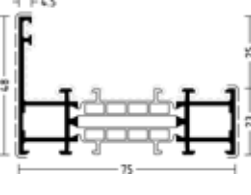
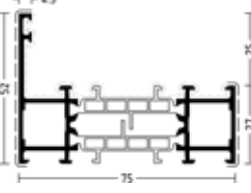

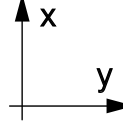
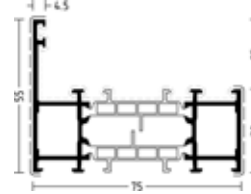
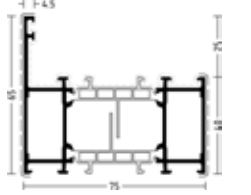
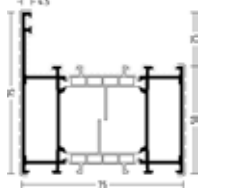
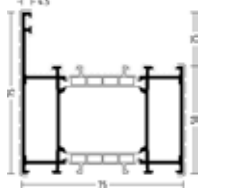
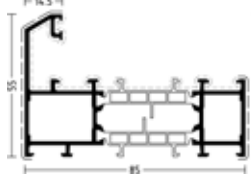
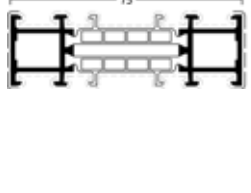
	Artikel-Nr. / Article-no.				
	lx	eff (cm ⁴) nach IfBt-Richtlinien eff (cm ⁴) acc. to IfBt guidelines			
	ly	add (cm ⁴) add (cm ⁴)			
Stützweite L ab (cm) Bearing span L from (cm)					
200 250 300 400					
	1010343				
	lx	19.01	21.06	22.37	23.85
	ly	6.84			
	1010344				
	lx	26.34	29.37	31.32	33.54
	ly	6.84			
	1010345				
	lx	21.13	23.68	25.35	27.25
	ly	12.35			
	1010346				
	lx	29.19	32.94	35.41	38.27
	ly	12.35			
	1917001				
	lx	22.80	25.00	26.37	27.90
	ly	4.22			
	1917002				
	lx	23.82	26.37	28.00	29.83
	ly	5.56			



	Artikel-Nr. / Article-no.				
	lx	eff (cm ⁴) nach IfBt-Richtlinien eff (cm ⁴) acc. to IfBt guidelines			
	ly	add (cm ⁴) add (cm ⁴)			
Stützweite L ab (cm) Bearing span L from (cm)					
200 250 300 400					
	1917003				
	lx	24.89	27.68	29.47	31.50
	ly	6.76			
	1917004				
	lx	28.19	31.60	33.82	36.36
	ly	12.11			
	1917005				
	lx	30.90	35.03	37.76	40.95
	ly	19.77			
	1910148				
	lx	30.40	34.62	37.43	40.73
	ly	19.77			
	1917009				
	lx	33.29	37.23	39.80	42.73
	ly	8.96			
	1917055				
	lx	18.98	20.60	21.60	22.70
	ly	1.37			

WICLINE 75

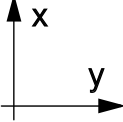
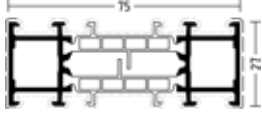
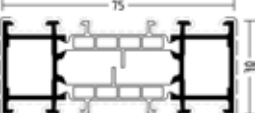
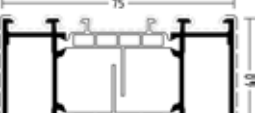
Blendrahmenprofile
Frame profiles

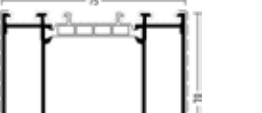
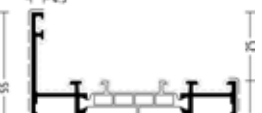
Statische Werte
Statical values

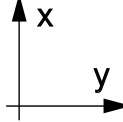
	Artikel-Nr. / Article-no.				
	lx	eff (cm ⁴) nach IfBt-Richtlinien eff (cm ⁴) acc. to IfBt guidelines			
	ly	add (cm ⁴) add (cm ⁴)			
		Stützweite L ab (cm) Bearing span L from (cm)			
		200	250	300	400
	1917056				
	lx	20.14	22.07	23.29	24.64
	ly	2.22			
	1917057				
	lx	21.28	23.42	24.78	26.30
	ly	3.03			
	1917058				
	lx	24.68	27.41	29.16	31.15
	ly	6.91			
	1917059				
	lx	27.57	30.98	33.21	35.77
	ly	12.85			
	1917060				
	lx	32.70	37.53	40.80	44.66
	ly	32.13			
	1917062				
	lx	25.30	28.21	30.10	32.24
	ly	6.04			

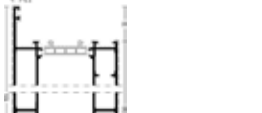
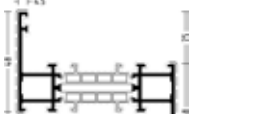
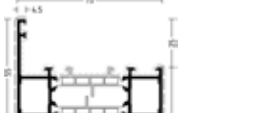
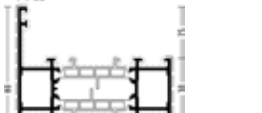

	Artikel-Nr. / Article-no.				
	lx	eff (cm ⁴) nach IfBt-Richtlinien eff (cm ⁴) acc. to IfBt guidelines			
	ly	add (cm ⁴) add (cm ⁴)			
		Stützweite L ab (cm) Bearing span L from (cm)			
		200	250	300	400
	1917064				
	lx	28.62	32.18	34.51	37.19
	ly	11.07			
	1917067				
	lx	36.02	41.76	45.72	50.47
	ly	41.77			
	1910172				
	lx	43.29	54.78	64.01	76.89
	ly	213.05			
	1917068				
	lx	27.58	30.63	32.58	34.79
	ly	7.07			
	1917069				
	lx	29.24	32.91	35.32	38.10
	ly	10.50			
	1917073				
	lx	27.50	30.81	32.97	35.43
	ly	12.61			

WICLINE 75

Blendrahmenprofile
Frame profiles

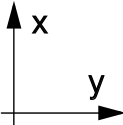
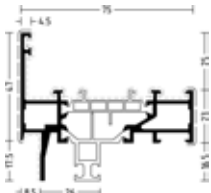
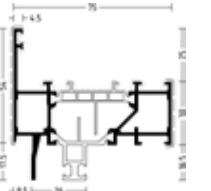
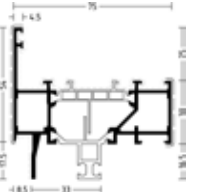
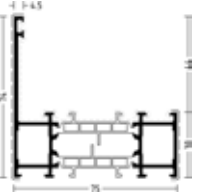
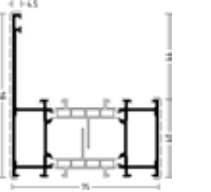
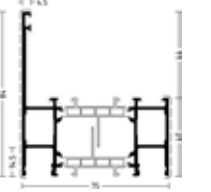
Statische Werte
Statical values

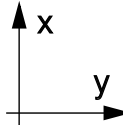
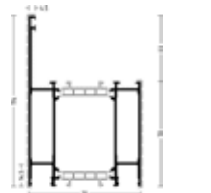
	Artikel-Nr. / Article-no.				
	lx	eff (cm ⁴) nach IfBt-Richtlinien eff (cm ⁴) acc. to IfBt guidelines			
	ly	add (cm ⁴) add (cm ⁴)			
Stützweite L ab (cm) Bearing span L from (cm)					
200 250 300 400					
	1917076				
	lx	23.45	26.22	28.02	30.07
	ly	6.69			
	1917077				
	lx	25.59	28.85	30.99	33.46
	ly	10.13			
	1910135				
	lx	25.59	28.85	30.99	33.46
	ly	10.13			
	1917081				
	lx	27.08	30.29	32.37	34.75
	ly	13.78			
	1917082				
	lx	30.39	34.26	36.80	39.74
	ly	20.85			
	1917086				
	lx	30.81	34.84	37.50	40.59
	ly	19.69			

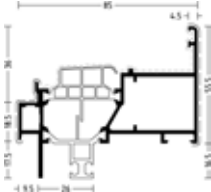
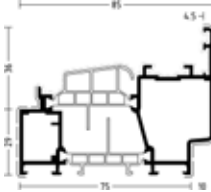
	Artikel-Nr. / Article-no.				
	lx	eff (cm ⁴) nach IfBt-Richtlinien eff (cm ⁴) acc. to IfBt guidelines			
	ly	add (cm ⁴) add (cm ⁴)			
Stützweite L ab (cm) Bearing span L from (cm)					
200 250 300 400					
	1910170				
	lx	34.32	41.01	45.86	51.98
	ly	57.04			
	1310991				
	lx	50.52	58.84	64.63	71.63
	ly	41.82			
	1917089				
	lx	24.00	26.87	28.73	30.86
	ly	13.41			
	1917092				
	lx	31.59	35.68	38.38	41.50
	ly	9.93			
	1917093				
	lx	31.95	36.68	39.90	43.70
	ly	13.16			

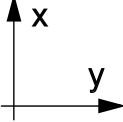
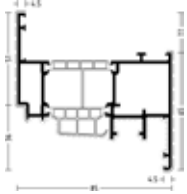
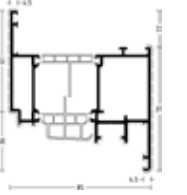
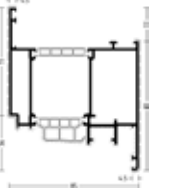
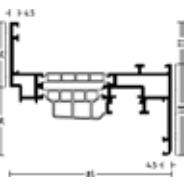
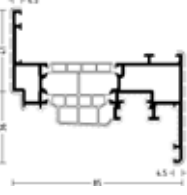
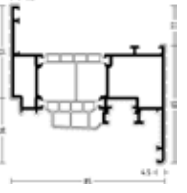
	Artikel-Nr. / Article-no.				
	lx	eff (cm ⁴) nach IfBt-Richtlinien eff (cm ⁴) acc. to IfBt guidelines			
	ly	add (cm ⁴) add (cm ⁴)			
Stützweite L ab (cm) Bearing span L from (cm)					
200 250 300 400					
	1917116				
	lx	37.44	43.42	47.54	52.50
	ly	16.96			
	1917117				
	lx	40.34	47.34	52.27	58.30
	ly	26.99			
	1917118				
	lx	42.79	50.76	56.46	63.57
	ly	40.22			
	1917101				
	lx	32.31	36.59	39.43	42.72
	ly	6.27			
	1917102				
	lx	34.64	39.65	43.04	47.03
	ly	9.53			
	1917103				
	lx	37.56	43.55	47.68	52.64
	ly	16.31			

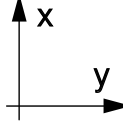
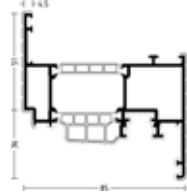
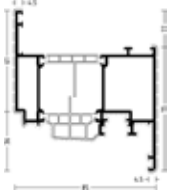
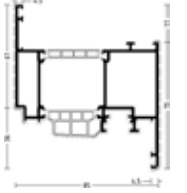
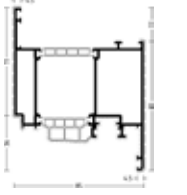
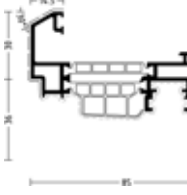
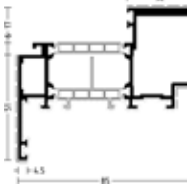
	Artikel-Nr. / Article-no.				
	lx	eff (cm ⁴) nach IfBt-Richtlinien eff (cm ⁴) acc. to IfBt guidelines			
	ly	add (cm ⁴) add (cm ⁴)			
Stützweite L ab (cm) Bearing span L from (cm)					
200 250 300 400					
	1910146				
	lx	37.56	43.55	47.68	52.64
	ly	16.31			
	1917104				
	lx	40.46	47.47	52.41	58.45
	ly	26.02			
	1910147				
	lx	40.46	47.47	52.41	58.45
	ly	26.02			
	1917115				
	lx	42.92	50.89	56.61	63.72
	ly	38.89			
	1917105				
	lx	31.85	36.23	39.16	42.58
	ly	6.36			
	1917161				
	lx	37.48	42.93	46.62	50.98
	ly	16.39			

WICLINE 75

Flügelprofile
Sash profiles

Statische Werte
Statical values

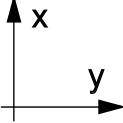
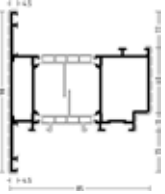
Artikel-Nr. / Article-no.													
	<table border="1"> <tr> <td>lx</td> <td>eff (cm⁴) nach IfBt-Richtlinien eff (cm⁴) acc. to IfBt guidelines</td> </tr> <tr> <td>ly</td> <td>add (cm⁴) add (cm⁴)</td> </tr> <tr> <td colspan="2"> Stützweite L ab (cm) Bearing span L from (cm) </td> </tr> <tr> <td colspan="2"> <table border="1"> <tr> <td>200</td> <td>250</td> <td>300</td> <td>400</td> </tr> </table> </td> </tr> </table>	lx	eff (cm ⁴) nach IfBt-Richtlinien eff (cm ⁴) acc. to IfBt guidelines	ly	add (cm ⁴) add (cm ⁴)	Stützweite L ab (cm) Bearing span L from (cm)		<table border="1"> <tr> <td>200</td> <td>250</td> <td>300</td> <td>400</td> </tr> </table>		200	250	300	400
	lx	eff (cm ⁴) nach IfBt-Richtlinien eff (cm ⁴) acc. to IfBt guidelines											
ly	add (cm ⁴) add (cm ⁴)												
Stützweite L ab (cm) Bearing span L from (cm)													
<table border="1"> <tr> <td>200</td> <td>250</td> <td>300</td> <td>400</td> </tr> </table>		200	250	300	400								
200	250	300	400										
													
1917163													
lx	<table border="1"> <tr> <td>41.13</td> <td>47.54</td> <td>51.93</td> <td>57.19</td> </tr> </table>	41.13	47.54	51.93	57.19								
41.13	47.54	51.93	57.19										
ly	30.27												

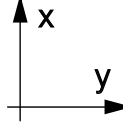
Artikel-Nr. / Article-no.													
	<table border="1"> <tr> <td>lx</td> <td>eff (cm⁴) nach IfBt-Richtlinien eff (cm⁴) acc. to IfBt guidelines</td> </tr> <tr> <td>ly</td> <td>add (cm⁴) add (cm⁴)</td> </tr> <tr> <td colspan="2"> Stützweite L ab (cm) Bearing span L from (cm) </td> </tr> <tr> <td colspan="2"> <table border="1"> <tr> <td>200</td> <td>250</td> <td>300</td> <td>400</td> </tr> </table> </td> </tr> </table>	lx	eff (cm ⁴) nach IfBt-Richtlinien eff (cm ⁴) acc. to IfBt guidelines	ly	add (cm ⁴) add (cm ⁴)	Stützweite L ab (cm) Bearing span L from (cm)		<table border="1"> <tr> <td>200</td> <td>250</td> <td>300</td> <td>400</td> </tr> </table>		200	250	300	400
	lx	eff (cm ⁴) nach IfBt-Richtlinien eff (cm ⁴) acc. to IfBt guidelines											
ly	add (cm ⁴) add (cm ⁴)												
Stützweite L ab (cm) Bearing span L from (cm)													
<table border="1"> <tr> <td>200</td> <td>250</td> <td>300</td> <td>400</td> </tr> </table>		200	250	300	400								
200	250	300	400										

WICLINE 75

Stulpflügelprofile
Double casement sash profiles

Statische Werte
Statical values

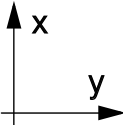
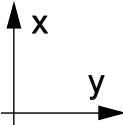
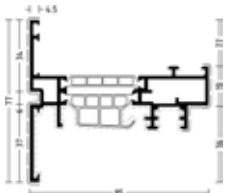
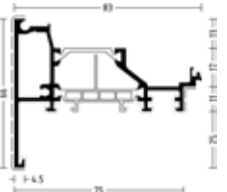
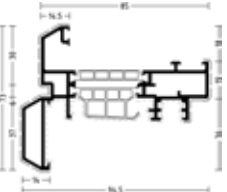
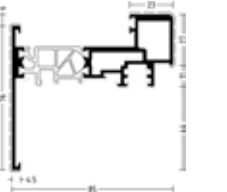
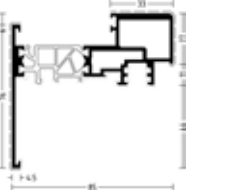
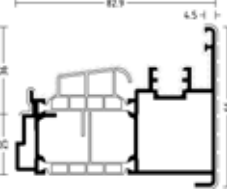
		Artikel-Nr. / Article-no.				
		lx	eff (cm ⁴) nach IfBt-Richtlinien eff (cm ⁴) acc. to IfBt guidelines			
		ly	add (cm ⁴) add (cm ⁴)			
		Stützweite L ab (cm) Bearing span L from (cm)				
			200	250	300	400
		1917120				
		lx	32.91	38.10	41.68	45.96
		ly	11.18			
		1917121				
		lx	25.59	28.46	30.31	32.41
		ly	9.64			
		1917122				
		lx	37.42	43.81	48.29	53.76
		ly	15.18			
		1917124				
		lx	31.05	37.65	42.57	48.93
		ly	14.90			
		1917126				
		lx	30.62	37.18	42.08	48.42
		ly	15.88			
		1917167				
		lx	33.03	36.72	39.09	41.77
		ly	13.17			

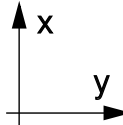
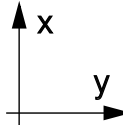

		Artikel-Nr. / Article-no.				
		lx	eff (cm ⁴) nach IfBt-Richtlinien eff (cm ⁴) acc. to IfBt guidelines			
		ly	add (cm ⁴) add (cm ⁴)			
		Stützweite L ab (cm) Bearing span L from (cm)				
			200	250	300	400

WICLINE 75

Kämpfer, Sprossenprofile
Transom, Crossbar profiles

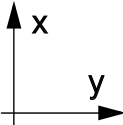
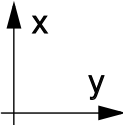
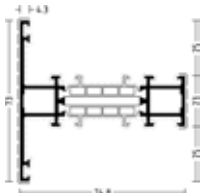
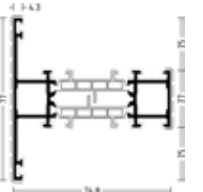
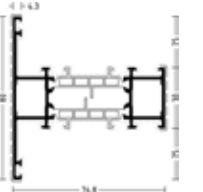
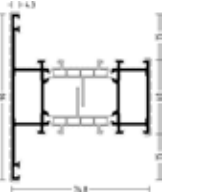
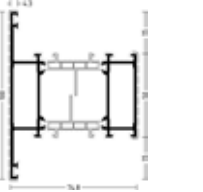
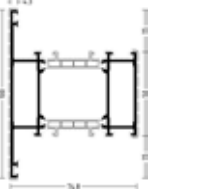
Statische Werte
Statical values

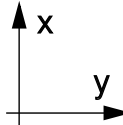
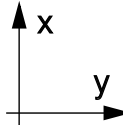
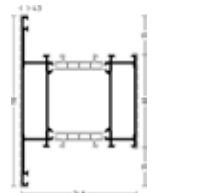
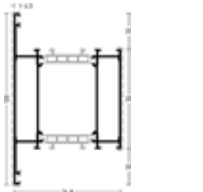
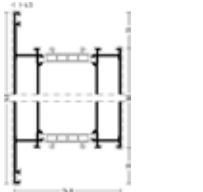
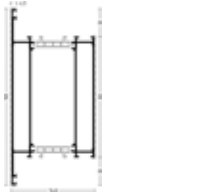
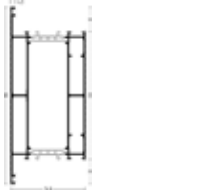
		Artikel-Nr. / Article-no.				
		lx	eff (cm ⁴) nach IfBt-Richtlinien eff (cm ⁴) acc. to IfBt guidelines			
		ly	add (cm ⁴) add (cm ⁴)			
		Stützweite L ab (cm) Bearing span L from (cm)				
			200	250	300	400
	1917201					
	lx	25.14	27.74	29.39	31.24	
	ly	8.52				
	1917202					
	lx	26.11	29.10	31.03	33.22	
	ly	10.45				
	1917203					
	lx	27.17	30.41	32.52	34.93	
	ly	12.13				
	1917204					
	lx	30.47	34.37	36.94	39.91	
	ly	19.20				
	1917205					
	lx	33.11	37.76	40.88	44.55	
	ly	28.84				
	1910149					
	lx	32.55	37.30	40.50	44.29	
	ly	28.84				

		Artikel-Nr. / Article-no.				
		lx	eff (cm ⁴) nach IfBt-Richtlinien eff (cm ⁴) acc. to IfBt guidelines			
		ly	add (cm ⁴) add (cm ⁴)			
		Stützweite L ab (cm) Bearing span L from (cm)				
			200	250	300	400
	1917206					
	lx	35.53	40.93	44.62	49.02	
	ly	41.33				
	1917207					
	lx	37.75	43.91	48.18	53.34	
	ly	57.00				
	1917209					
	lx	42.48	50.44	56.16	63.30	
	ly	100.21				
	1917211					
	lx	46.00	55.49	62.50	71.48	
	ly	160.00				
	1917213					
	lx	50.90	62.97	72.28	84.74	
	ly	246.21				
	1917215					
	lx	53.89	67.54	78.32	93.10	
	ly	353.74				

WICLINE 75

Kämpfer, Sprossenprofile
Transom, Crossbar profiles

Statische Werte
Statical values

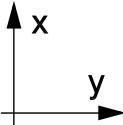
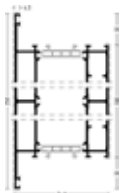
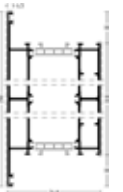
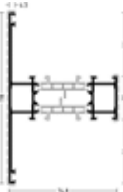
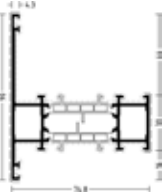
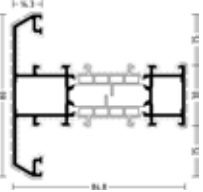
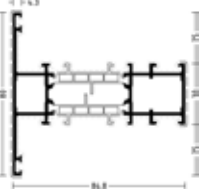
	Artikel-Nr. / Article-no.				
	lx	eff (cm ⁴) nach IfBt-Richtlinien eff (cm ⁴) acc. to IfBt guidelines			
	ly	add (cm ⁴) add (cm ⁴)			
		Stützweite L ab (cm) Bearing span L from (cm)			
		200	250	300	400
	1917220				
	lx	59.98	77.54	92.20	113.54
	ly	769.17			
	1917224				
	lx	64.66	85.95	104.02	131.52
	ly	1281.31			
	1917231				
	lx	30.21	34.11	36.67	39.64
	ly	33.41			
	1917235				
	lx	28.23	31.69	33.96	36.55
	ly	17.80			
	1917334				
	lx	36.51	41.14	44.19	47.70
	ly	18.72			
	1917331				
	lx	35.96	40.72	43.87	47.53
	ly	12.69			

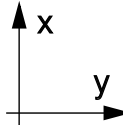
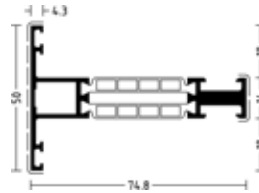
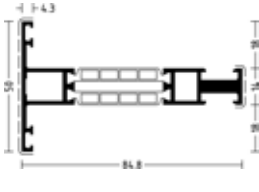
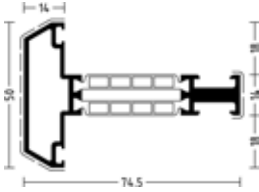
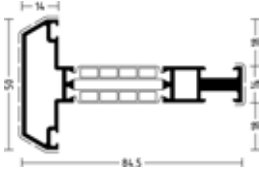
	Artikel-Nr. / Article-no.				
	lx	eff (cm ⁴) nach IfBt-Richtlinien eff (cm ⁴) acc. to IfBt guidelines			
	ly	add (cm ⁴) add (cm ⁴)			
		Stützweite L ab (cm) Bearing span L from (cm)			
		200	250	300	400
	1917336				
	lx	22.41	24.50	25.81	27.25
	ly	2.93			
	1917337				
	lx	30.57	33.75	35.78	38.04
	ly	3.06			
	1917338				
	lx	21.78	23.94	25.30	26.82
	ly	5.09			
	1917339				
	lx	30.10	33.47	35.63	38.08
	ly	5.23			

WICLINE 75

Stützenprofile
Mullion profiles for windows

Statische Werte
Statical values

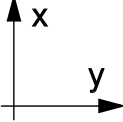
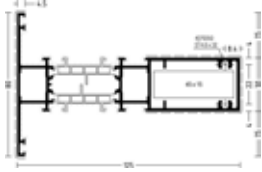
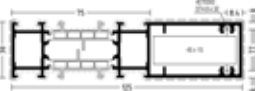
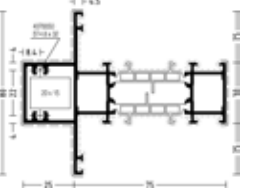
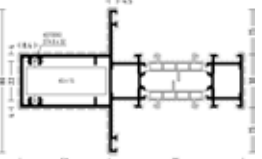
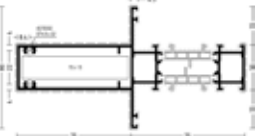
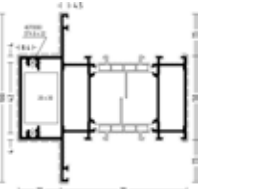
	Artikel-Nr. / Article-no.				
	lx	eff (cm ⁴) nach IfBt-Richtlinien eff (cm ⁴) acc. to IfBt guidelines			
	ly	add (cm ⁴) add (cm ⁴)			
Stützweite L ab (cm) Bearing span L from (cm)					
200 250 300 400					
	1917241				
	lx	92.42	106.78	116.62	128.39
	ly	17.10			
	1917244				
	lx	76.80	85.57	91.23	97.66
	ly	7.52			
	1917246				
	lx	45.59	51.39	55.21	59.61
	ly	15.14			
	1917247				
	lx	76.46	85.38	91.15	97.73
	ly	17.10			
	1917248				
	lx	125.45	138.54	146.87	156.21
	ly	18.89			
	1917249				
	lx	57.09	65.71	71.58	78.56
	ly	38.42			

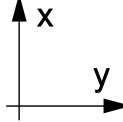
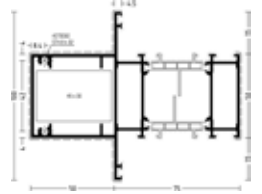
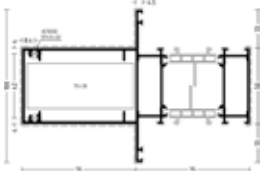
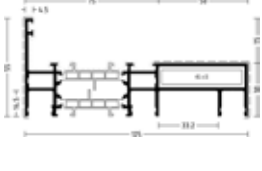
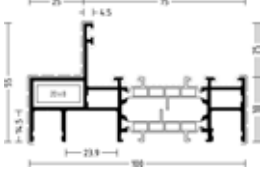
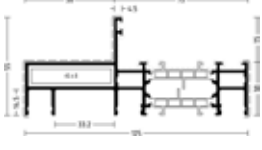
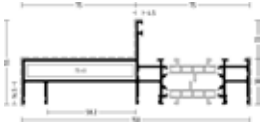
	Artikel-Nr. / Article-no.				
	lx	eff (cm ⁴) nach IfBt-Richtlinien eff (cm ⁴) acc. to IfBt guidelines			
	ly	add (cm ⁴) add (cm ⁴)			
Stützweite L ab (cm) Bearing span L from (cm)					
200 250 300 400					
	1917250				
	lx	94.98	108.24	117.11	127.51
	ly	44.46			
	1917251				
	lx	128.42	173.24	186.00	200.70
	ly	49.69			
	1917256				
	lx	82.67	94.08	101.70	110.61
	ly	8.04			
	1917258				
	lx	43.72	49.14	52.70	56.78
	ly	6.97			
	1917259				
	lx	74.16	82.93	88.63	95.12
	ly	8.09			
	1917260				
	lx	121.12	134.27	142.68	152.16
	ly	8.53			

WICLINE 75

Stützenprofile
Mullion profiles for windows

Statische Werte
Statical values

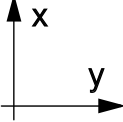
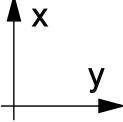
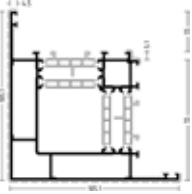
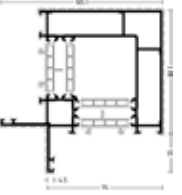
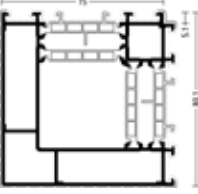
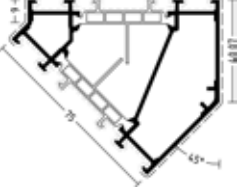

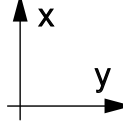
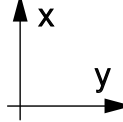
		Artikel-Nr. / Article-no.			
		lx	eff (cm ⁴) nach IfBt-Richtlinien eff (cm ⁴) acc. to IfBt guidelines		
		ly	add (cm ⁴) add (cm ⁴)		
		Stützweite L ab (cm) Bearing span L from (cm)			
		200	250	300	400
		1917270			
		lx	66.84	66.84	66.84
		ly	68.47		
		1917271			
		lx	58.39	66.52	70.88
		ly	66.63		
		1917272			
		lx	51.27	54.50	56.43
		ly	49.11		
		1917273			
		lx	24.00	26.46	28.02
		ly	14.25		

		Artikel-Nr. / Article-no.			
		lx	eff (cm ⁴) nach IfBt-Richtlinien eff (cm ⁴) acc. to IfBt guidelines		
		ly	add (cm ⁴) add (cm ⁴)		
		Stützweite L ab (cm) Bearing span L from (cm)			
		200	250	300	400

WICLINE 75

Schwellenprofile
Threshold profiles

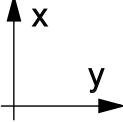
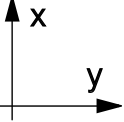
Statische Werte
Statical values

		Artikel-Nr. / Article-no.				
		lx	eff (cm ⁴) nach IfBt-Richtlinien eff (cm ⁴) acc. to IfBt guidelines			
		ly	add (cm ⁴) add (cm ⁴)			
		Stützweite L ab (cm) Bearing span L from (cm)				
			200	250	300	400
		1917304				
		lx	14.58	16.70	18.12	19.80
		ly	0.57			
		1917305				
		lx	14.18	16.30	17.73	19.44
		ly	0.56			

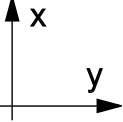
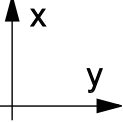
		Artikel-Nr. / Article-no.				
		lx	eff (cm ⁴) nach IfBt-Richtlinien eff (cm ⁴) acc. to IfBt guidelines			
		ly	add (cm ⁴) add (cm ⁴)			
		Stützweite L ab (cm) Bearing span L from (cm)				
			200	250	300	400

WICLINE 75

Bauanschlussprofile
Profiles for junction to structure

Statische Werte
Statical values

Artikel-Nr. / Article-no.	
lx	eff (cm ⁴) nach IfBt-Richtlinien eff (cm ⁴) acc. to IfBt guidelines
ly	add (cm ⁴) add (cm ⁴)
Stützweite L ab (cm) Bearing span L from (cm)	
200 250 300 400	

	1917307			
	lx	57.35	65.57	71.10
ly	19.65			

Artikel-Nr. / Article-no.	
lx	eff (cm ⁴) nach IfBt-Richtlinien eff (cm ⁴) acc. to IfBt guidelines
ly	add (cm ⁴) add (cm ⁴)
Stützweite L ab (cm) Bearing span L from (cm)	
200 250 300 400	

WICLINE 75

Aufsatzprofile
Supplementary profiles

Statische Werte
Statical values

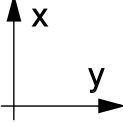
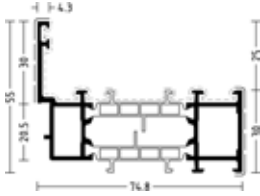
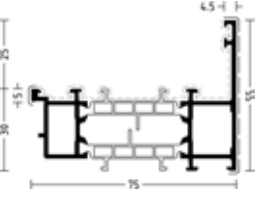
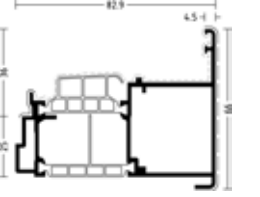
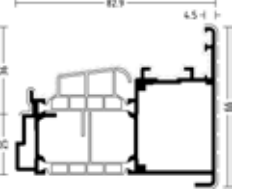
		Artikel-Nr. / Article-no.				
		lx	eff (cm ⁴) nach IfBt-Richtlinien eff (cm ⁴) acc. to IfBt guidelines			
		ly	add (cm ⁴) add (cm ⁴)			
		Stützweite L ab (cm) Bearing span L from (cm)				
			200	250	300	400
		1917301				
		lx	23.02	25.49	27.07	28.84
		ly	5.46			
		1917303				
		lx	21.91	24.18	25.62	27.24
		ly	6.26			
		1917165				
		lx	30.79	34.63	37.14	40.04
		ly	13.29			
		1917166				
		lx	32.85	36.48	38.81	41.43
		ly	14.13			

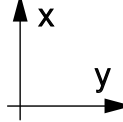
		Artikel-Nr. / Article-no.				
		lx	eff (cm ⁴) nach IfBt-Richtlinien eff (cm ⁴) acc. to IfBt guidelines			
		ly	add (cm ⁴) add (cm ⁴)			
		Stützweite L ab (cm) Bearing span L from (cm)				
			200	250	300	400

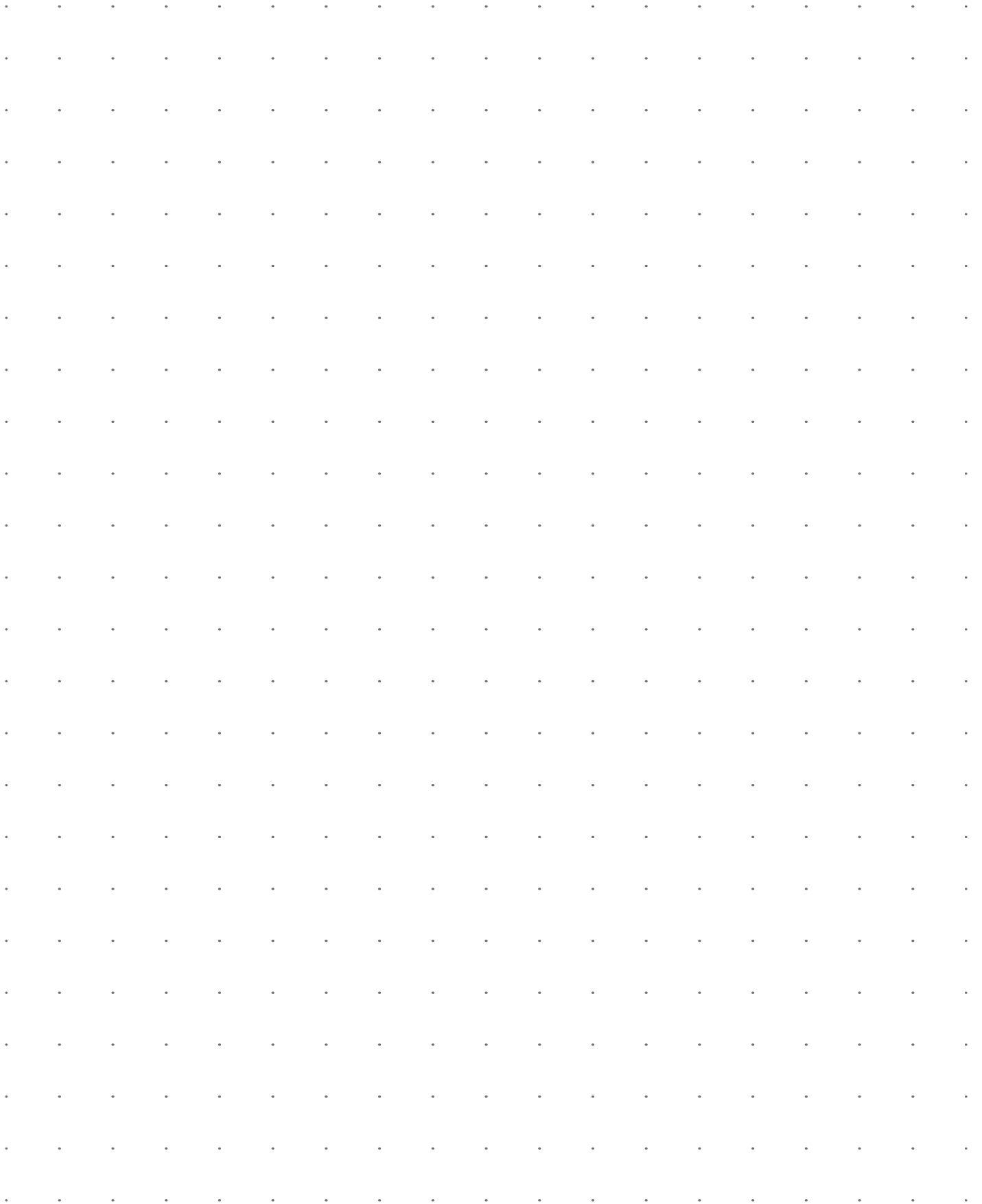

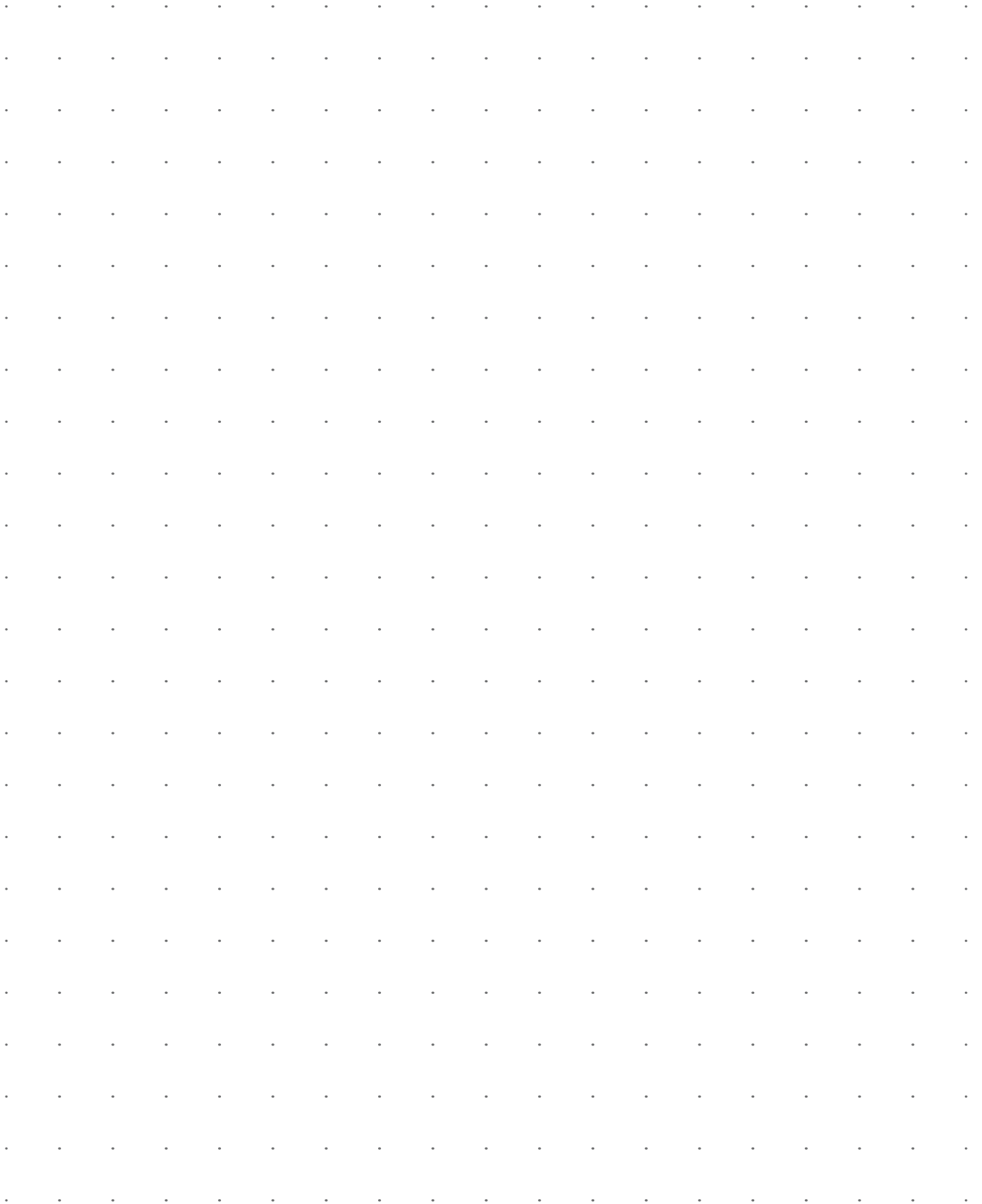

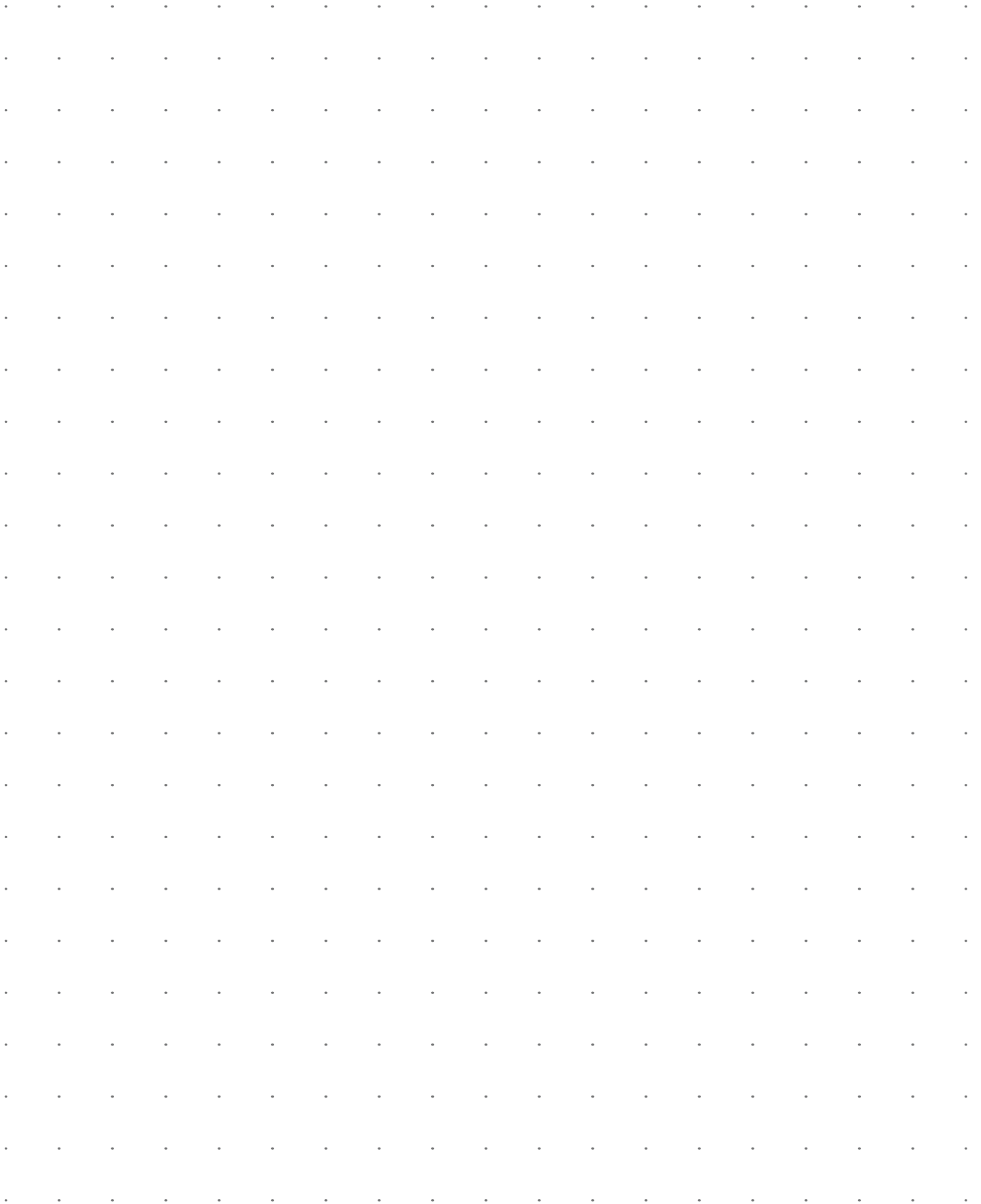



WICONA Design Service

Ideen werden gebaute Wirklichkeit

Eine der größten aktuellen Herausforderungen bei der Gestaltung unserer Zukunft ist die Erstellung architektonisch gehaltvoller und zugleich ökologisch verantwortungsvoller Gebäudeentwürfe, die dem nachhaltigen Klimaschutz Rechnung tragen. Von großer Bedeutung sind in diesem Zusammenhang Konzepte, die Ressourcen schonen, einen hohen Nutzerkomfort bieten und die Arbeits- und Wohngesundheit gewährleisten. Hydro Building Systems hat dies schon vor Jahren erkannt und die Weichen entsprechend gestellt.



Als Aluminium-Systemhaus verfügen wir über die erforderlichen Kompetenzen in unserer speziell auf diese Bedürfnisse ausgerichteten Planungs- und Beratungsabteilung WICONA Design Service, damit Ihre Ideen gebaute Wirklichkeit werden – auch unter Einhaltung wirtschaftlicher Vorgaben. Viele mit unterschiedlichen Gebäudezertifikaten wie DGNB, Leeds, Passivhaus oder Minergie ausgezeichnete Objekte sind Beispiele für das kreative, konstruktive und erfolgreiche Zusammenwirken von Auftraggeber, Planer, Fassadenbauer und WICONA weltweit.

Sprechen Sie einfach unseren WICONA Design Service oder Ihr zuständiges WICONA Vertriebsbüro an.

Wir freuen uns auf Ihre Idee!

Ideas become built reality

One of the most challenging tasks in shaping our future is the creation of buildings which comply at the same time to ambitious architectural design and environmental responsibility. This requires concepts which protect natural resources, offer a superior user comfort, and respect the living and working health and safety requirements. And above all they have to be economically attractive.



At Hydro Building Systems we have identified these needs already years ago and adjusted our product development and service offer accordingly, especially within our Design Service destined to the consulting of architects and planners. As an aluminium system supplier we can supply you with the competences which are required to turn your ideas into built reality - while at the same time respecting economic aspects. A multitude of buildings certified with green building labels like DGNB, Leeds, Passive house or Minergie are exemplary for the creative, constructive and successful cooperation between investor, architect, fabricator and WICONA. All over the world.

Simply contact our WICONA Design Service or the WICONA office in your region.

We are looking forward to your ideas!

Deutschland**Hydro Building Systems GmbH**

Söflinger Straße 70
89077 Ulm
Telefon +49 731 3984-0
www.wicona.de

**Hydro Building Systems GmbH
Design Service**

Söflinger Straße 70
89077 Ulm
Telefon +49 731 3984-462

**Hydro Building Systems GmbH
Verkaufsbüro Nord-West**

Business-Kontor in'n Hafen
Philosophenweg 31-33
47051 Duisburg
Telefon +49 203 45046-0

**Hydro Building Systems GmbH
Verkaufsbüro Nord-Ost**

Johann-Eck-Straße 2
04315 Leipzig
Telefon +49 341 989795-0

**Hydro Building Systems GmbH
Verkaufsbüro Mitte**

Donnersbergstraße 1
64646 Heppenheim
Telefon +49 6252 6736-0

**Hydro Building Systems GmbH
Verkaufsbüro Süd**

Söflinger Straße 70
89077 Ulm
Telefon +49 731 3984-441

Schweiz**Hydro Building Systems AG**

Gewerbepark
Postfach 30
5506 Mägenwil
Telefon +41 62 88741-41
www.wicona.ch

Österreich**Hydro Building Systems GmbH**

Wallerseestraße 49
5201 Seekirchen
Telefon +43 6212 2000
www.wicona.at

Sweden**Hydro Building Systems AB**

Grusåsvägen 10
352 45 Växjö
Phone +46 470 78 74 00
www.wicona.se

Denmark**Salgskontor Danmark**

Hydro Building Systems
Erhvervsparken 6
8400 Ebeltoft
Phone +45 7020 2048
www.wicona.de

Norway**Hydro Building Systems AB**

Drammensveien 260
0283 Oslo
Phone +47 22 42 22 00
www.wicona.no

Poland**Hydro Building Systems Sp. z o.o.**

ul. Mińska 63A
03-828 Warszawa
Phone +48 22 3308170
www.wicona.com

Russia**ООО Гидро Билдинг Системс**

RUS-123317, Россия, Москва
ул. Тестовская, д. 10
«Москва-Сити»
БЦ «Северная башня»
Тел. +7 495 708 45 96
www.wicona.ru

Estonia / Latvia / Lithuania**Hydro Building Systems OÜ**

Pärnu mnt. 139 f
11317, Tallinn
Phone +37 2657 6635
www.wicona.com

Czech Republic**Hydro Building Systems spol. s r.o.**

Holandská 8
63900 Brno
Phone +420 (0) 543 422030
www.wicona.cz

Hungary**Hydro Building Systems Kft.**

Graphisoft Park, Záhony u 7.
1031 Budapest
Phone +36 (1) 4533457
www.wicona.at

France**Hydro Building Systems S.a.r.l.**

Rue Jean-Baptiste Godin
Parc d'Activités Le Plateau
02200 Courmelles
Tel. +33 3 23 59 82 00
www.wicona.fr

Benelux**Hydro Building Systems N.V.**

Welvaartstraat 14/1
2200 Herentals
Telefoon +32 14 24 99 99
www.wicona.be

Italia**Hydro Building Systems S.p.A.**

Centro Servizi WICONA
Via Stazione 133/X
30035 Ballò di Mirano (VE)
Telefono +39 041 51 38 633
www.wicona.it

United Kingdom**Hydro Building Systems Ltd.**

Silkwood Park
Wakefield WF5 9TG
United Kingdom
Phone +44 845 602 8799
www.wicona.co.uk

Ireland**Hydro Building Systems**

Unit J1 Baldonnell Business Park
Naas Road
Dublin 22, Eire
Phone +353 1 4105766
www.wicona.ie

España**Hydro Building Systems S.I.**

Camí de Ca n'Ametller, 18
08195 Sant Cugat del Vallès
Barcelona
Teléfono +34 902 22 23 23
www.wicona.es

International**Hydro Building Systems S.a.r.l.**

270 rue Léon Joulin
BP 63709
31037 Toulouse cedex 01
Téléphone +33 5 61 31 26 26
www.wicona-int.com

China**Hydro Building Systems Co. Ltd**

5C-15 LIANDO International Industry Park
Maju Bridge
Tongzhou District, Beijing, PRC 101102
Phone +8610 6059 5686
www.wicona.cn

WICONA®

North East Europe (NEE)
Hydro Building Systems GmbH

Söflinger Straße 70
89077 Ulm
Telefon +49 731 3984-0
www.wicona.de

North West Europe (NWE)
Hydro Building Systems S.a.r.l.

Rue Jean-Baptiste Godin
Parc d'Activités Le Plateau
02200 Courmelles
Téléphone +33 3 23 59 82 00
www.wicona.fr

South East Europe (SEE)
Hydro Building Systems S.p.A.

Customer Service
Via Stazione 133/X
30035 Ballò di Mirano (VE)
Telefono +39 041 51 38 633
www.wicona.it

South West Europe (SWE)
Hydro Building Systems S.I.

Southwest SLU
Camí de Ca n'Ametller, 18
08195 Sant Cugat del Vallès
Barcelona
Teléfono +34 902 22 23 23
www.wicona.es

International
Hydro Building Systems S.a.r.l.

270 rue Léon Joulin
BP 63709
31037 Toulouse cedex 01
Téléphone +33 5 61 31 26 26
www.wicona-int.com

0150/071 08240



WICONA is a Hydro brand

HYDRO