

Ssz	Fólianév	Szín	Vonaltípus	Vonal- vastagság
1	0	fekete/fehér	Continuous	Alapért.
2	Kiemelt	kék	Continuous	0.7
3	Közép	vörös	Közép2	0.18
4	Méret	zöld	Continuous	0.18
5	Segéd	vkék	Continuous	0.18
6	Sraffozás	sárga	Continuous	0.18
7	Szaggatott	bíbor	Szaggatott2	0.25
8	Szöveg1	zöld	Continuous	0.18
9	Szöveg2	fekete/fehér	Continuous	0.25
10	Szöveg3	kék	Continuous	0.5
11	Vastag	fekete/fehér	Continuous	0.5
12	Vékony	vkék	Continuous	0.18

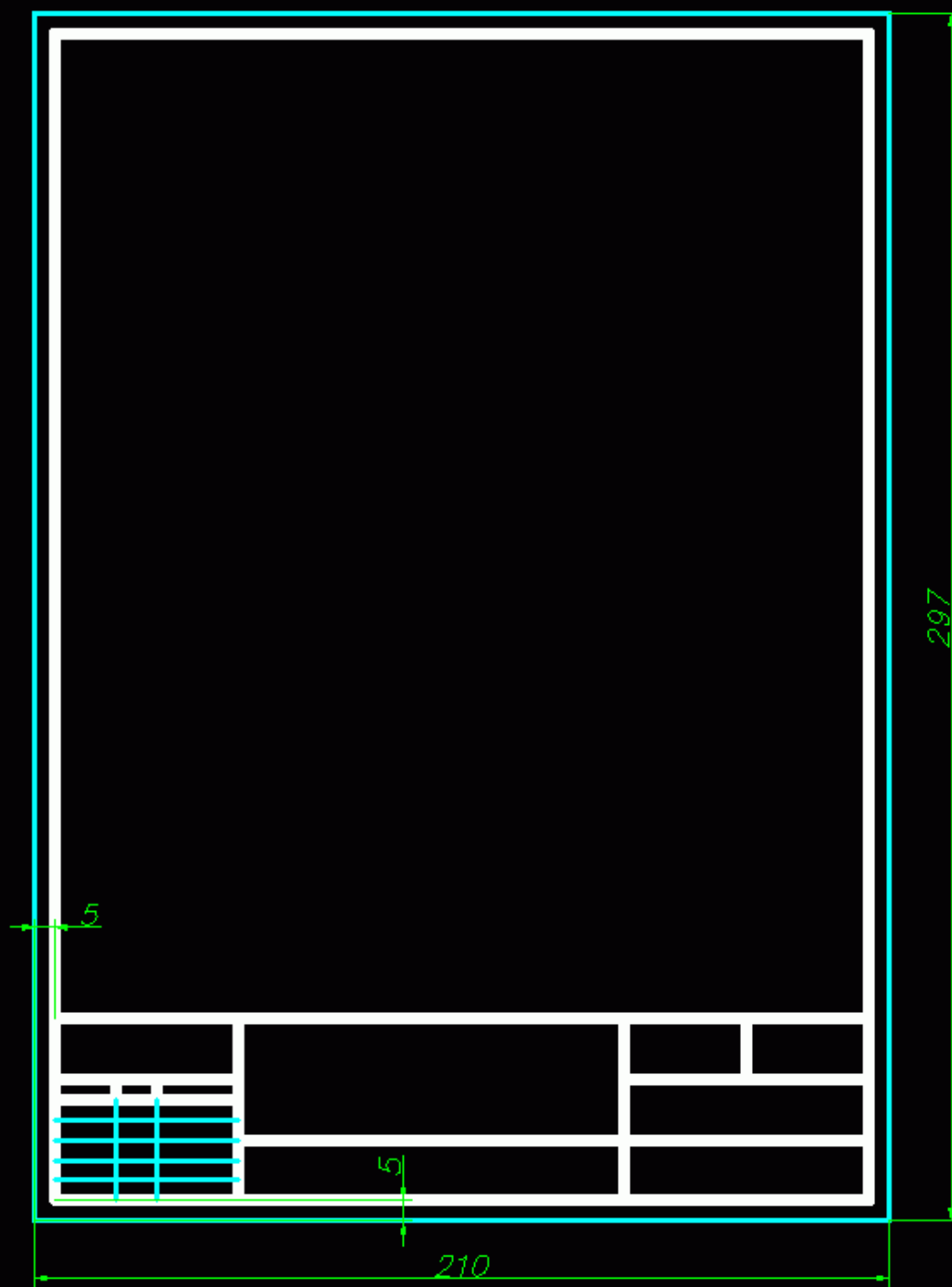

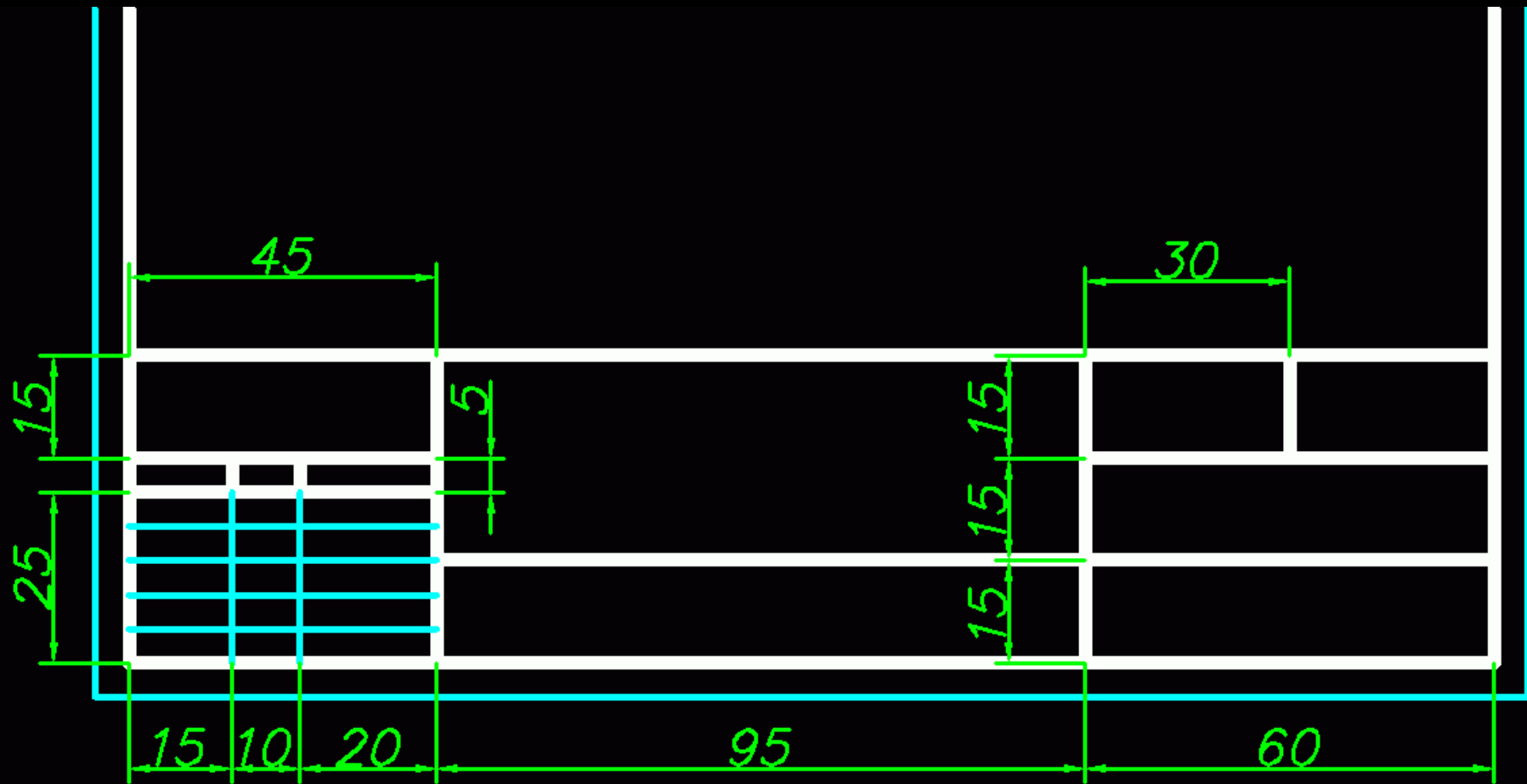

Anyag:

Tárgy:

Méret:

Tömeg:

Kelt

Aláírás

Tervező

Rajzoló

Másoló

Ellenőr

Szabv.e

Név:

Rajzsám:

PTE MIK

Mező megnevezése	Betűmagasság	Aktuális fólia
Kelt	2.5 mm	Szöveg1
Aláírás		
Tervező		
Rajzoló		
Másoló		
Ellenőr		
<u>Szabv.e.</u>		
Anyag:	3.5 mm	Szöveg2
Név:		
<u>Méret:</u>		
Tömeg:		
Rajzszám:		
Tárgy:		
PTE MIK	7 mm	Szöveg3

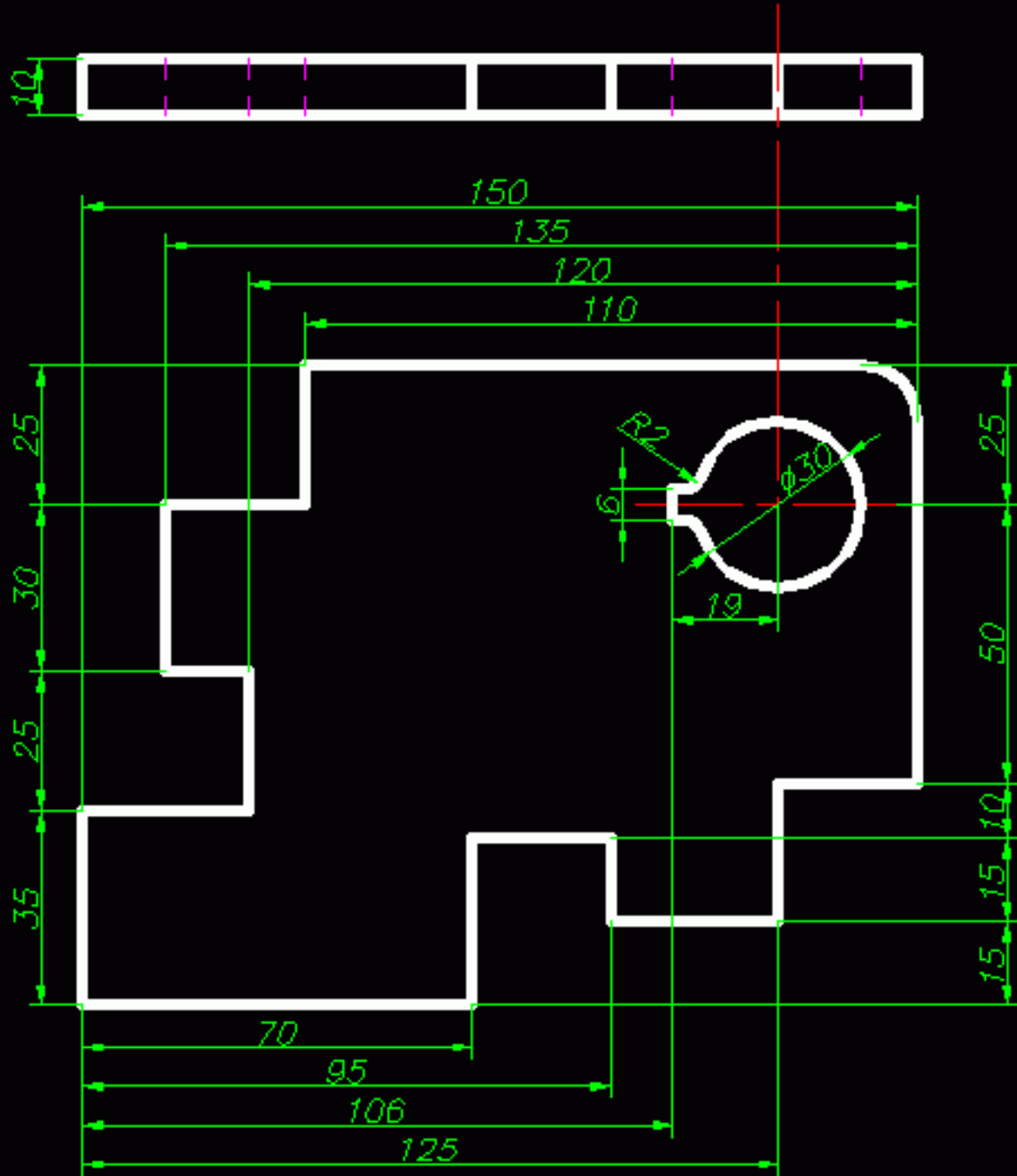

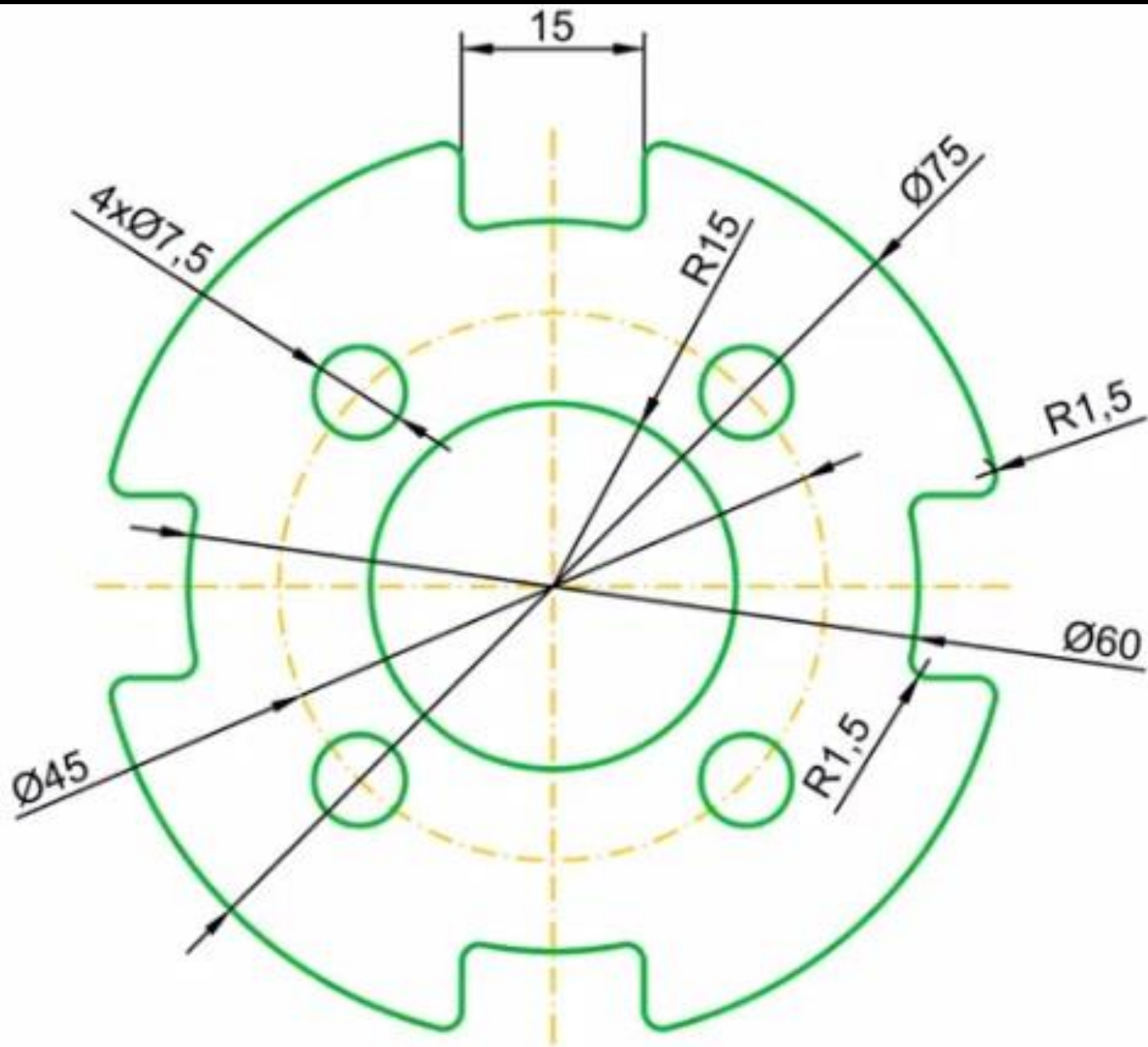

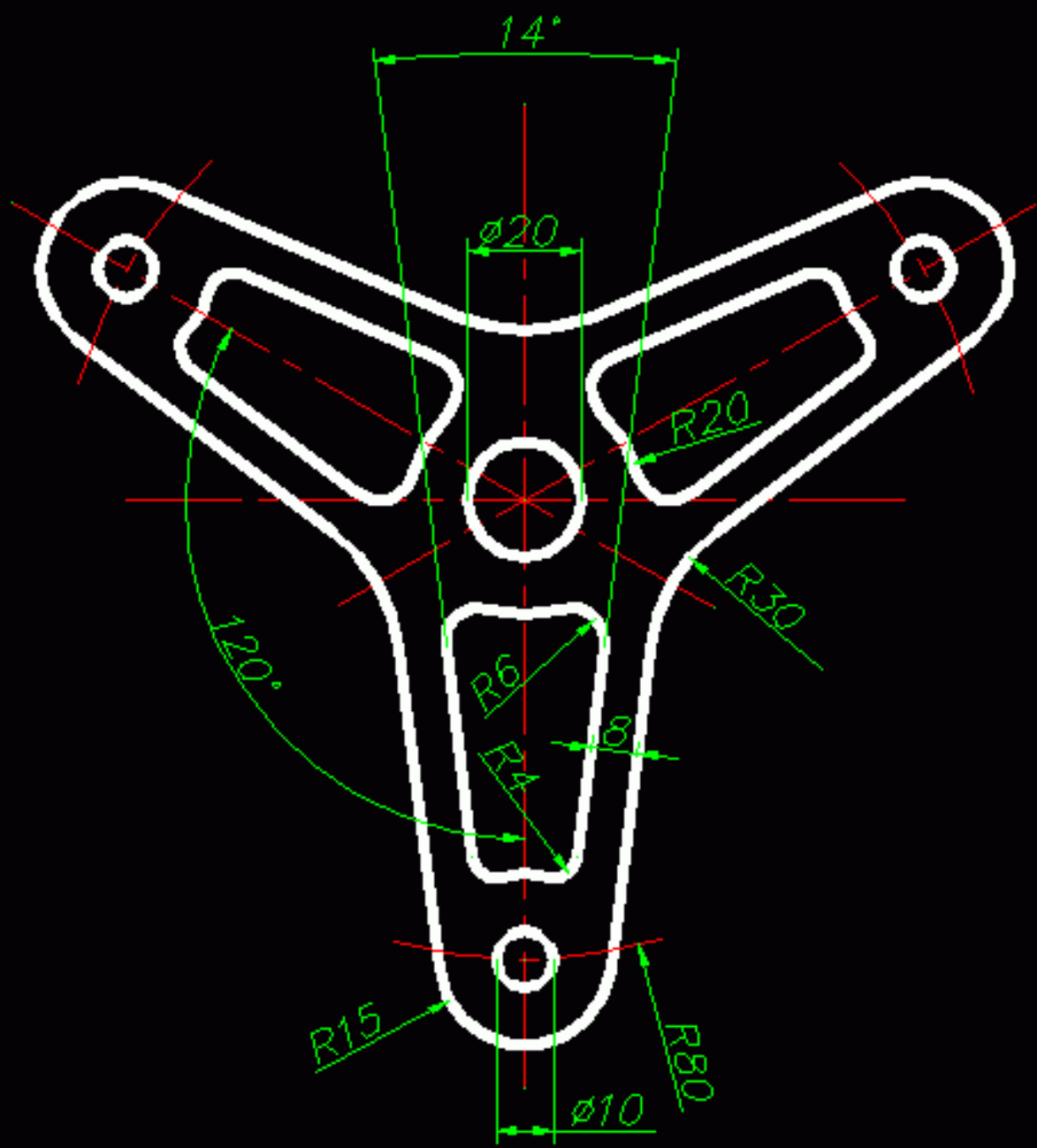

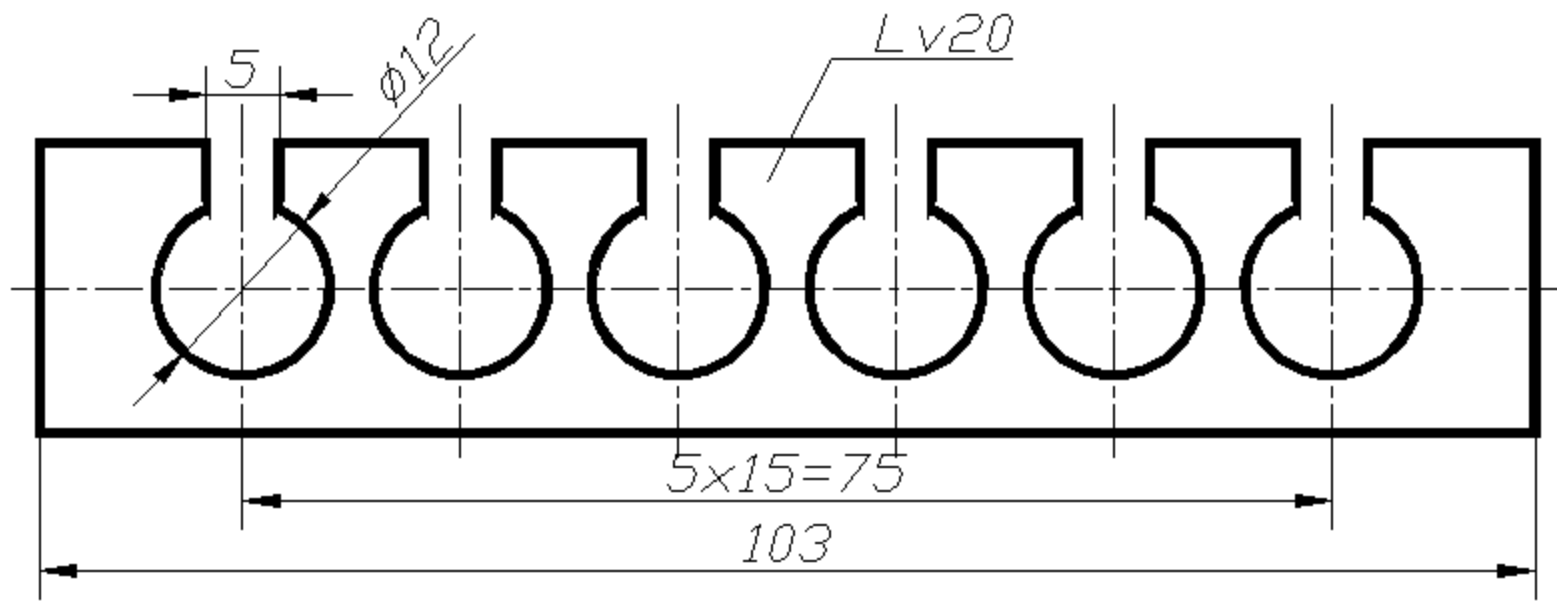

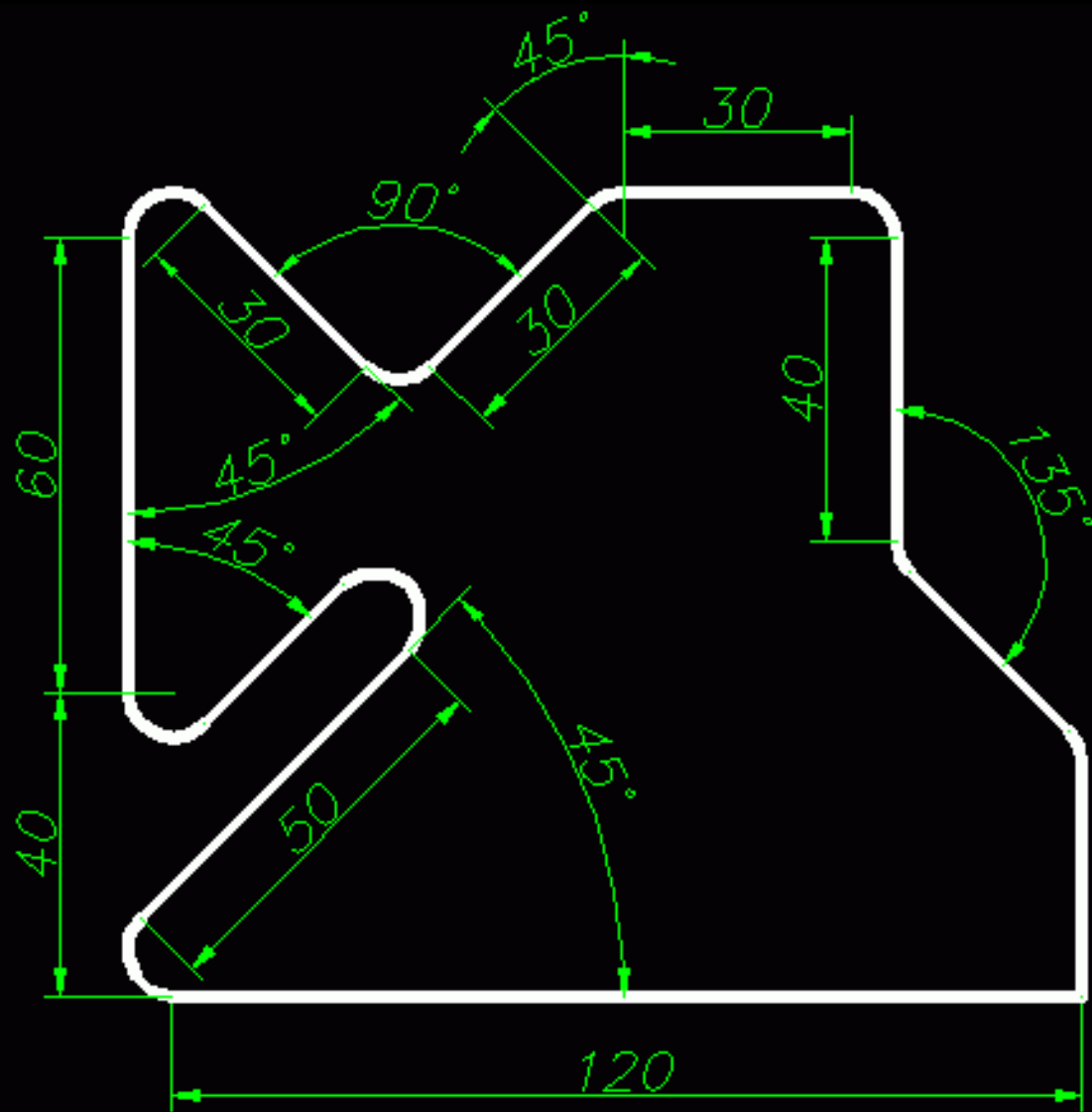

Minden sugár R6

